

Panasonic[®]

Facsimile

Operating Instructions (For Facsimile)

UF-490

Options
UE-403167

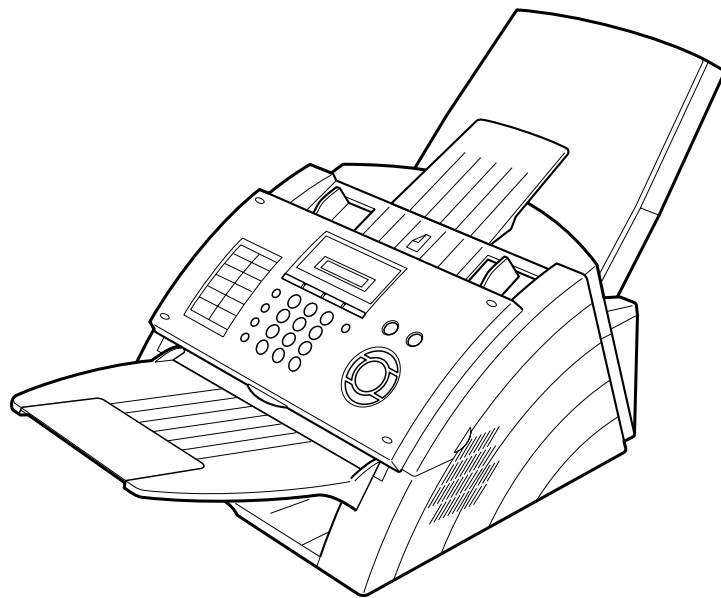

Before operating this equipment, please read these instructions completely and keep these operating instructions for future reference.

English

Getting to Know
Your Machine

Installing Your
Machine

Programming
Your Machine

Basic Operations

Advanced
Features

Network Features

Printout Journals
and Lists

Problem Solving

Appendix

IMPORTANT INFORMATION

When requesting information, supplies or service always refer to the model and serial number of your machine. The model and serial number plate (Main Name Plate) is located on the machine as shown below. For your convenience, space is provided below to record information you may need in the future.

Model No.

Serial No.

Date of Purchase

Dealer

Address

Telephone Number

() -

Supplies Telephone Number

() -

Service Telephone Number

() -

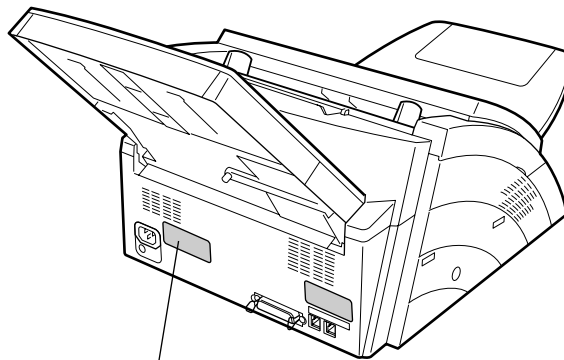

Model and Serial Number

Table of Contents

Getting to Know Your Machine

Safety Information.....	6
Precaution.....	8
Function Key.....	9
External View.....	10
Control Panel.....	11

Installing Your Machine

Main Unit and Accessories.....	13
Installing the Accessories.....	14
Installing the Drum Unit/Toner Cartridge Assembly.....	15
Loading the Recording Paper.....	17
■ Paper Specifications.....	17
Connecting the Telephone Line Cable and Power Cord.....	18
Setting the Dialing Method (Tone or Pulse).....	20
Adjusting the Volume.....	21
User Parameters.....	22
■ General Description.....	22
■ Setting the Date and Time.....	22
■ Setting Your LOGO (NAME/COMPANY).....	23
■ Setting Your Character ID.....	24
■ Setting Your ID Number (Fax Telephone Number).....	25
Entering Characters.....	26

Programming Your Machine

One-Touch/Abbreviated Dialing Numbers.....	27
■ Entering One-Touch/Abbreviated Dialing Numbers.....	27
■ Editing One-Touch/Abbreviated Dialing Numbers.....	29
■ Printing Out a Directory Sheet.....	31
Customizing Your Machine.....	32
■ General Description.....	32
■ Setting the Fax Parameters.....	32
■ Fax Parameter Table.....	33

Basic Operations

Loading Documents.....	36
■ Documents You Can Send.....	36
■ Documents You Cannot Send.....	36
■ How to Load Documents.....	37
Basic Transmission Settings.....	38
■ General Description.....	38
■ Contrast.....	38
■ Resolution.....	38
■ Communication Journal (COMM. JOURNAL).....	39

Table of Contents

Sending Documents	40
■ General Description	40
■ Memory Transmission.....	41
■ Direct Transmission	46
■ Voice Mode Transmission.....	50
■ Transmission Reservation	52
■ Redialing	54
Receiving Documents	56
■ Reception Modes	56
■ Telephone Mode	57
■ Fax / Tel Auto Switching Mode	58
■ Fax Mode	59
■ TAM (Telephone Answering Machine) Interface Mode.....	59
■ Print Reduction	61
■ Receiving Oversize Documents	62
■ Substitute Memory Reception	63
■ Print Collation Mode.....	63
Making Copies	64

Advanced Features

Timer Controlled Communications	65
■ General Description	65
■ Deferred Transmission.....	65
Polling	66
■ General Description	66
■ Setting the Polling Password	66
■ To Poll Documents from Another Station.....	67
Program Keys	68
■ General Description	68
■ Setting for Group Dialing.....	68
■ Setting for Deferred Transmission	69
■ Setting for Polling.....	70
■ Setting for One-Touch Key	71
■ Changing or Erasing the Program Key Settings	72
Access Code	73
■ General Description	73
■ Setting the Access Code.....	73
■ Operating Your Machine with the Access Code (Restrict All Operations)	74
■ Operating Your Machine with the Access Code (Restrict Access of Fax Parameters Only)	74
Distinctive Ring Detector (DRD)	75
■ General Description	75
PIN Code Access	76
■ General Description	76
■ Selecting the Access Method (Prefix or Suffix)	76
■ Dialing with a PIN Code	77
Fax Forward	78
■ Setting Fax Forward.....	78

Table of Contents

Network Features

Sub-Addressing	79
■ General Description.....	79
■ Setting the Sub-Address into a One-Touch/ABBR. Dialing Numbers	80
■ Sending a Fax with Sub-Address	81

Printout Journals and Lists

Journals and Lists	82
■ General Description.....	82
■ Transaction Journal.....	82
■ Individual Transmission Journal (IND. XMT JOURNAL)	83
■ Communication Journal (COMM. JOURNAL)	86
■ One-Touch/Abbreviated and Directory Search List.....	88
■ Program List.....	91
■ FAX Parameter List	92
■ Toner Cartridge and Drum Unit Supply Order Forms.....	93
■ Power Failure Report	94

Problem Solving

Troubleshooting	95
■ Information Codes	99
■ Clearing a Recording Paper Jam	101
■ Clearing a Document Jam.....	102
■ Cleaning the Document Scanning Area	103
■ Cleaning the Printer Roller	104
■ Adjusting the Automatic Document Feeder (ADF)	105
■ Checking the Telephone Line.....	106

Appendix

Specifications	107
Recording Paper Specifications	109
Options and Supplies	110
FCC Notice for User in USA	111
Notice to User in Canada	113
Glossary	115
ITU-T Image No. 1	118
Index	119

Safety Information

⚠ WARNING denotes a potential hazard that could result in serious injury or death.

- TO PREVENT FIRE OR SHOCK, DO NOT EXPOSE THIS PRODUCT TO RAIN OR ANY TYPE OF MOISTURE.
- TO MINIMIZE THE POSSIBILITY OF SHOCK OR DAMAGE TO THE MACHINE, IT MUST BE PROPERLY GROUNDED.
- THIS PRODUCT UTILIZES A LASER. ONLY QUALIFIED SERVICE PERSONNEL SHOULD ATTEMPT TO SERVICE THIS DEVICE DUE TO POSSIBLE EYE INJURY. CAUTION-USE OF CONTROLS OR ADJUSTMENTS OR PERFORMANCE OF PROCEDURES OTHER THAN THOSE SPECIFIED HEREIN MAY RESULT IN HAZARDOUS RADIATION EXPOSURE.



- THE MAIN PLUG ON THIS EQUIPMENT MUST BE USED TO DISCONNECT THE MAIN POWER. PLEASE ENSURE THAT THE SOCKET OUTLET IS INSTALLED NEAR THE EQUIPMENT AND SHALL BE EASILY ACCESSIBLE.
- MAKE SURE THAT THE MACHINE IS INSTALLED IN A SPACIOUS OR WELL VENTILATED ROOM SO AS NOT TO INCREASE THE AMOUNT OF OZONE IN THE AIR. SINCE OZONE IS HEAVIER THAN AIR, IT IS RECOMMENDED THAT AIR AT FLOOR LEVEL BE VENTILATED.

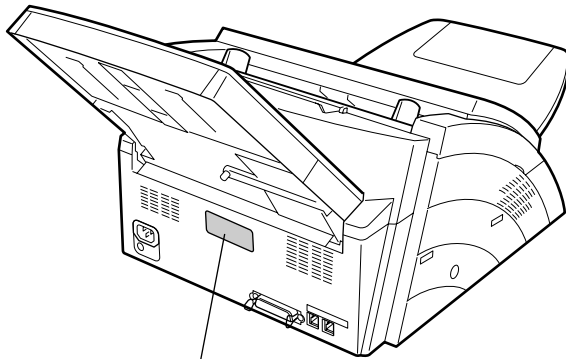

Product complies with DHHS Rules 21
CFR Subchapter J in effect at date
of manufacture.

Manufacturer's name and address Factory ID

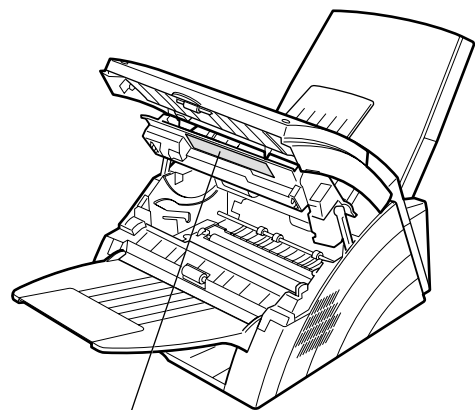

- **DANGER** : Invisible laser radiation when open and interlock defeated. AVOID DIRECT EXPOSURE TO BEAM.
- **CAUTION** : Invisible and hazardous laser radiation when interlocks defeated. AVOID EXPOSURE TO BEAM.
- **ATTENTION** : Rayonnement laser invisible dangereux lorsque la sécurité est neutralisée. EXPOSITION DANGEREUSE AU FAISCEAU.
- **VORSICHT** : Unsichtbare Laserstrahlung, wenn Sicherheitsverriegelung überbrückt. NICHT DEM STRAHL AUSSETZEN.
- **PELIGRO** : Cuando se invalida el bloqueo se producen radiaciones invisibles de láser. EVITESE LA EXPOSICIÓN DIRECTA A TALES RAYOS.
- **VARO!** : Näkymätöntä ja vaarallista lasersäteilyä suojalukitus ohitettaessa. Vältä suoraan altistumista säteelle.
- **ADVARSEL** : USYNLIG LASERSTRÅLING NÅR SIKKERHEDSAF-BRYDERE ER UDE AF FUNKTION. UNDGÅ UDSETTELSE FOR STRÅLING.
- **ADVARSEL** : USYNLIG LASERSTRÅLING NÅR SIKKERHEDS-LÅS BRYTES. UNNGÅ EKSPONERING FOR STRÅLEN.
- **VARNING** : OSYNLIG LASERSTRÅLNING NÅR SPÄRRAR ÄR URKOPPLADE. STRÅLEN ÄR FARLIG.
- **注意** : 为防止激光照射, 当连接本机时, 请勿暴露于光柱下。
- **주의** : 연결장치가 고장 났을 때에는 눈에 보이지않고 위험한 레이저 방사선이 빛에 직접 닿지않도록 해 주십시오.

FBS8902

Safety Information

⚠ CAUTION denotes hazards that could result in minor injury or damage to the machine.

- TO REDUCE THE RISK OF SHOCK OR FIRE, USE ONLY NO. 26 AWG OR LARGER TELEPHONE LINE CABLE.
- DISCONNECT ALL POWER TO THE MACHINE BEFORE COVER(S) ARE REMOVED. REPLACE THE COVER(S) BEFORE THE UNIT IS RE-ENERGIZED.

⚠ IMPORTANT SAFETY INSTRUCTIONS

When using your telephone equipment, basic safety precautions should always be followed to reduce the risk of fire, electric shock and injury to persons, including the following:

- DO NOT USE THIS PRODUCT NEAR WATER, FOR EXAMPLE, NEAR A BATH TUB, WASH BOWL, KITCHEN SINK OR LAUNDRY TUB, IN A WET BASEMENT OR NEAR A SWIMMING POOL.
- AVOID USING A TELEPHONE (OTHER THAN A CORDLESS TYPE) DURING AN ELECTRICAL STORM. THERE MAY BE A REMOTE RISK OF ELECTRIC SHOCK FROM LIGHTNING.
- DO NOT USE THE TELEPHONE TO REPORT A GAS LEAK IN THE VICINITY OF THE LEAK.
- USE ONLY THE POWER CORD INDICATED IN THIS MANUAL.

Precaution

CAUTION

denotes hazards that could result in minor injury or damage to the machine.

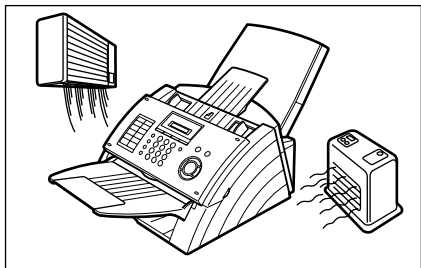

Do not install the machine near heating or an air conditioning unit.

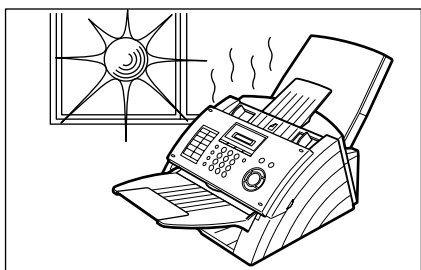

Avoid exposure to direct sunlight.

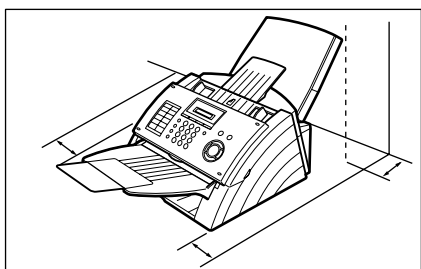

Install the machine on a flat surface, leave at least 4 inches (10 cm) of space between the machine and other objects.

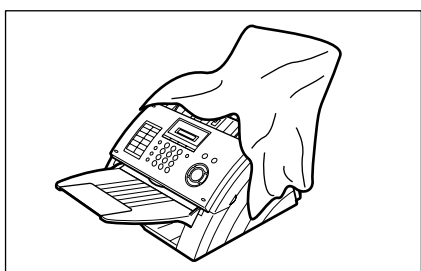

Do not block the ventilation openings.



Do not place heavy objects or spill liquids on the machine.

Function Key

Any function can be started by first pressing **FUNCTION** and then enter the function number, or by pressing **▼** or **▲** scroll keys repeatedly until the desired function appears on the display.

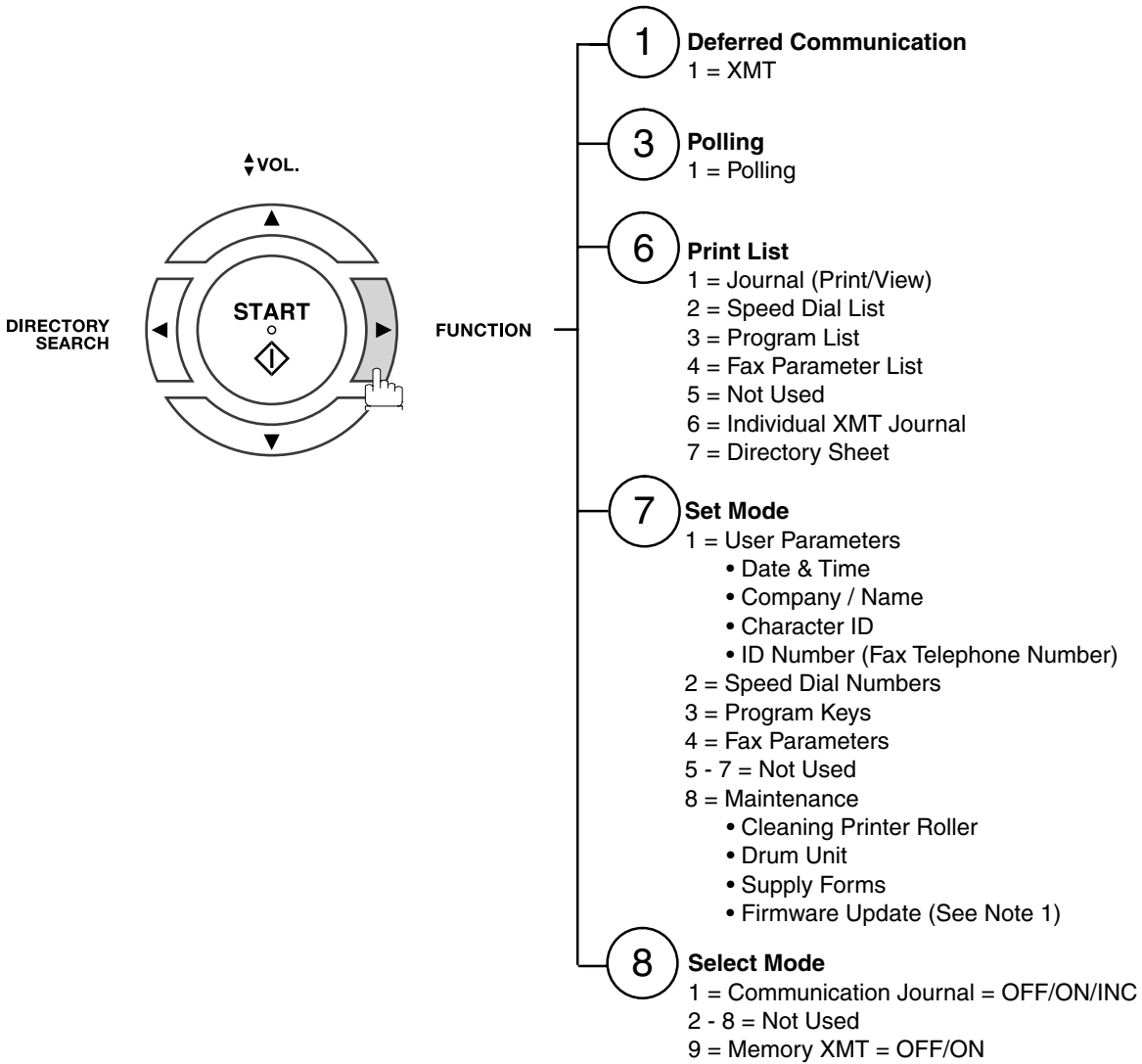



NOTE

1. Refer to *Firmware Update Utility's Operating Instructions* on the software CD for additional details.

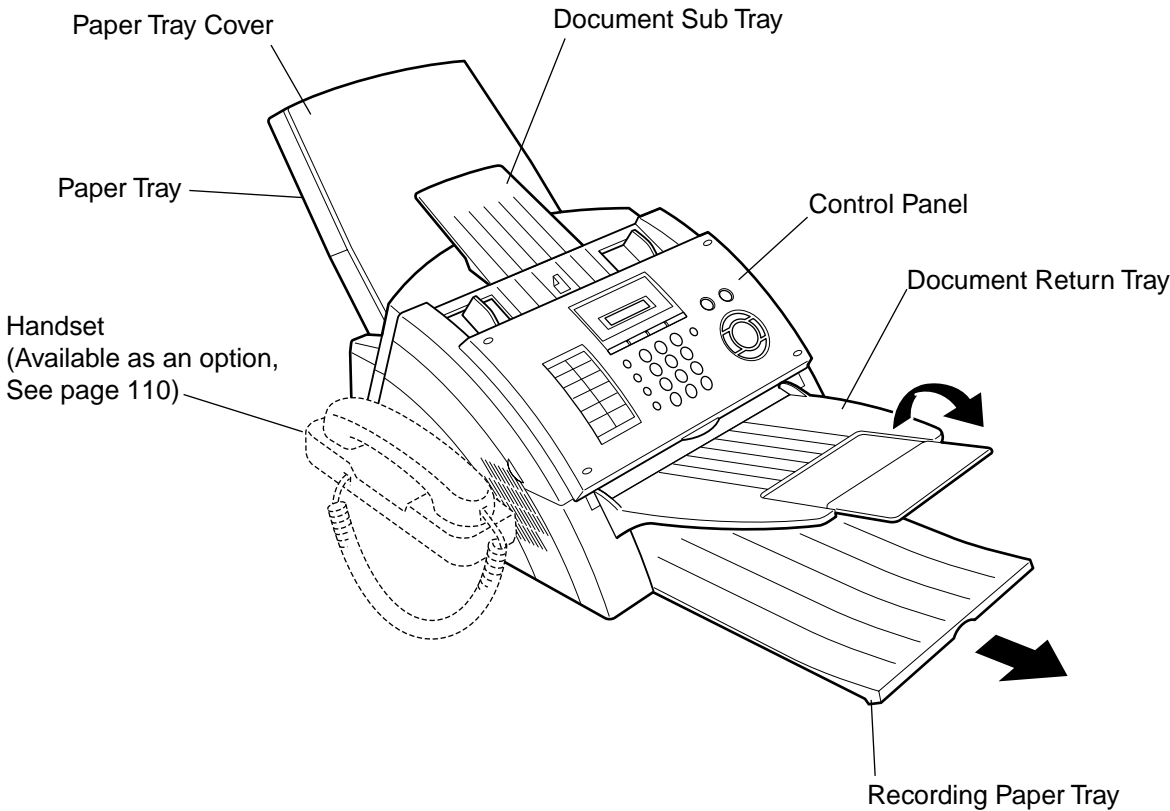
External View

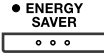

Control Panel

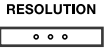
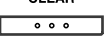
	- Used to switch the machine into energy saving mode. (See page 34)
	- Used to set Normal, Lighter or Darker. (See page 38)
	- Used to set Standard, Fine, Super-Fine or Halftone. (See page 38)
	- Use this button when resetting all the previously set functions.

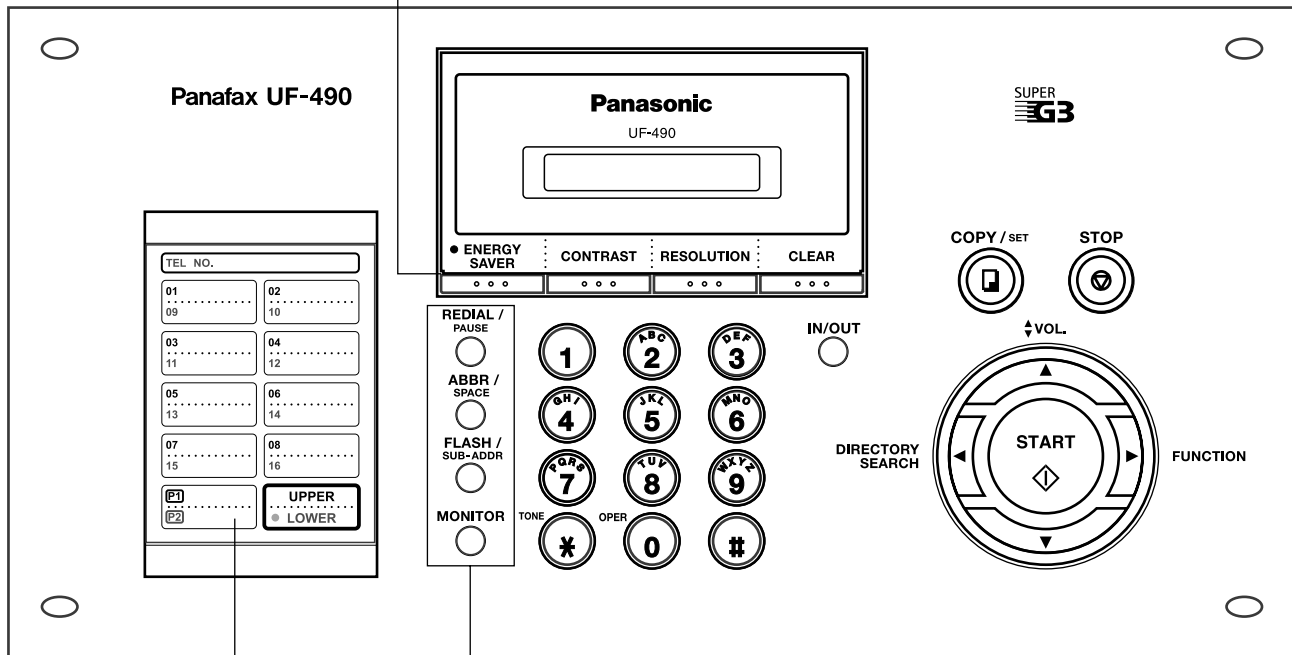

One-Touch Keys (01-16)
- Used for One-Touch Dialing. (See pages 43 and 47)

Program Keys (P1-P2)
- Used to record long dialing procedures or Group Dialing Number keys. (See pages 68 to 72)

UPPER/LOWER Key
- Used to switch between upper and lower key.

REDIAL / PAUSE
- Used to enter a pause when recording or dialing a telephone number, or to redial the last dialed number.

ABBR / SPACE
- Used to start Abbreviated Dialing and insert a space while entering LOGO, character ID and station name. (See pages 43 and 48)

FLASH / SUB-ADDR
- Used to separate the Sub-Address from the telephone number

MONITOR
- Used to start On-Hook Dialing. (See page 51)

Control Panel

LCD Display
Indicates date and time, or the current status can be confirmed by one of the following colors.

Green : Machine is activated for communication, printing data or scanning a document.

Orange: Document(s) are set on ADF. The machine is ready to Accept or Perform a task.

Red : An error has occurred or the machine needs immediate attention.

STOP
 - Press this button when you want to stop telecommunication, registration operation, or audible tone.

COPY / SET
 - Used to make copies and set operations. (See page 64)

IN/OUT
 - Used to select either IN mode or OUT mode. (See page 56)

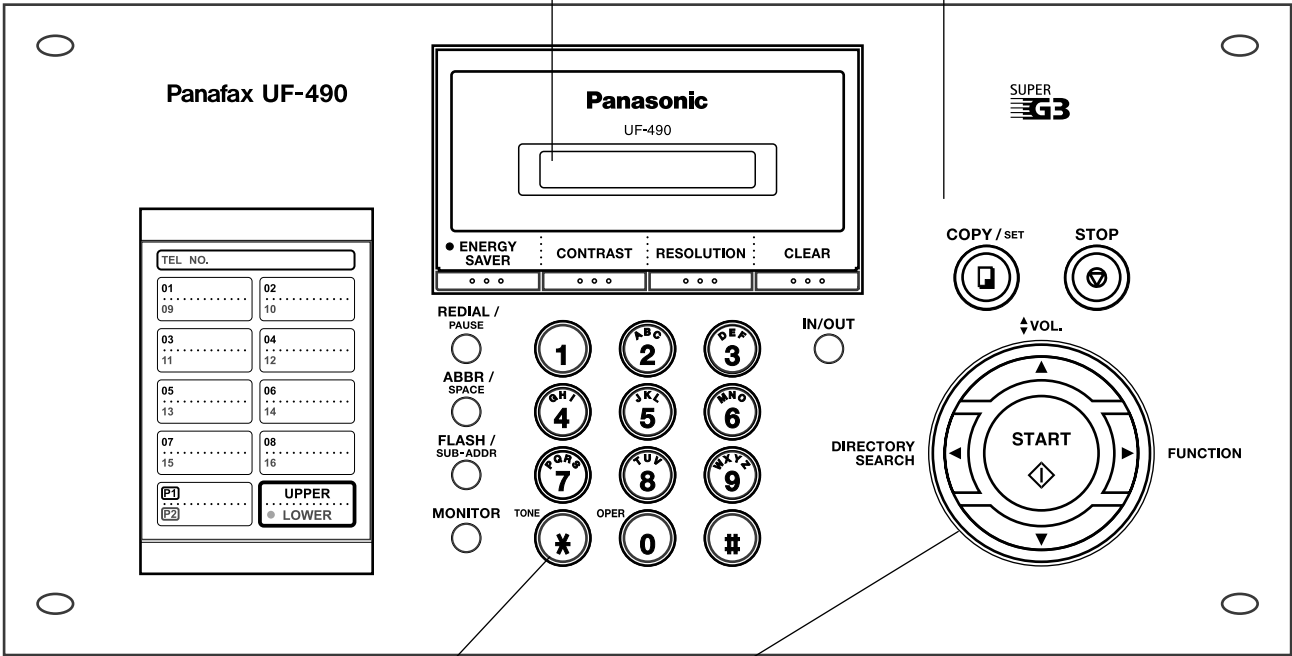

Keypad
- Used for manual number dialing, recording phone numbers, and numerical entries.

Tone Key
- Used to temporarily change the dialing mode to Tone when Pulse mode is set.

START
Used for the following:

- Start or select the function.
- Search for a station name. (See pages 44 and 49)
- Adjust the monitor and ringer volume. (See page 21)
- Move the cursor while entering numbers and characters.
- Search the station name for Directory Search Dialing.
- Confirm the entered station for multi-station communication.
- Confirm the current communication modes (e.g. Page number, ID, Dialed Telephone number, File number) when the unit is ON LINE.

Main Unit and Accessories

Unpack the carton and check that you have all the accessories illustrated.

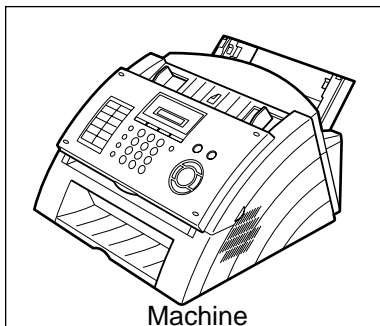

Machine

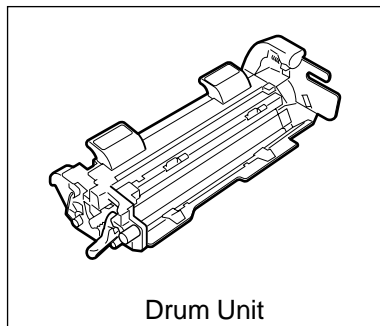

Drum Unit

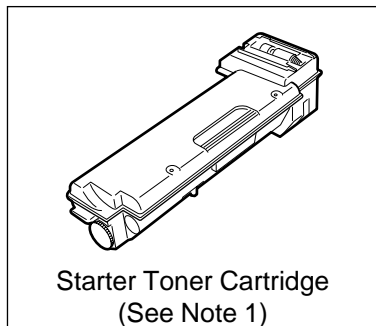

Starter Toner Cartridge
(See Note 1)

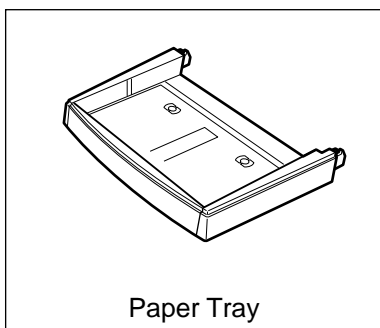

Paper Tray

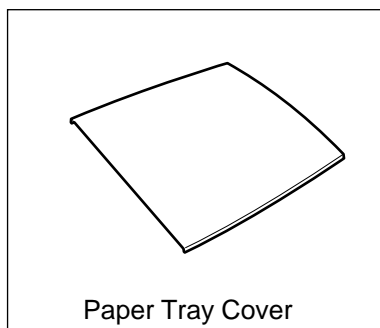

Paper Tray Cover

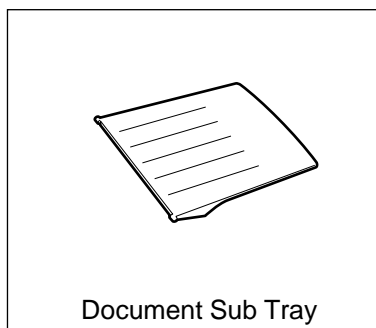

Document Sub Tray

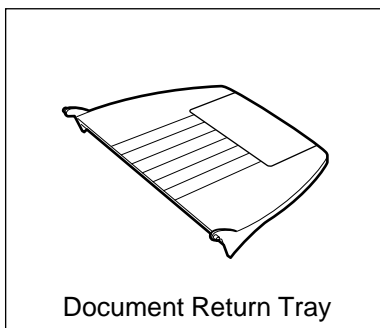

Document Return Tray

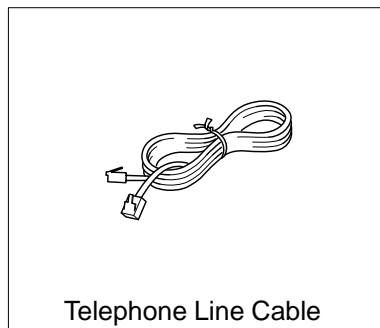

Telephone Line Cable

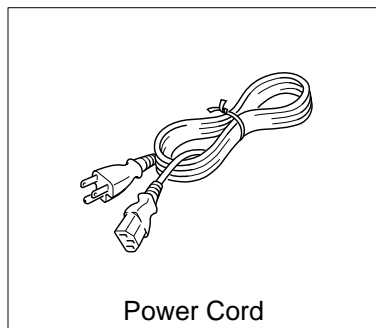

Power Cord

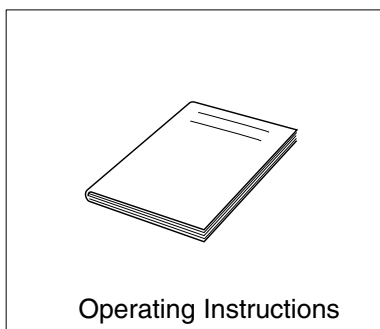

Operating Instructions



CD-ROM

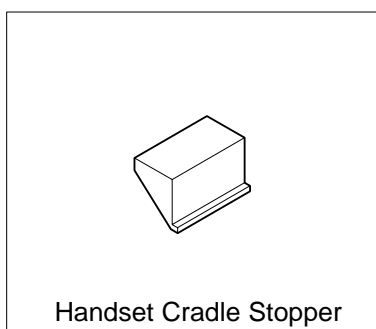

Handset Cradle Stopper

NOTE

1. The Starter Toner Cartridge yields approx. 1,000 pages. (Based on 3% Black, ITU-T Image No. 1 Chart)

Installing the Accessories

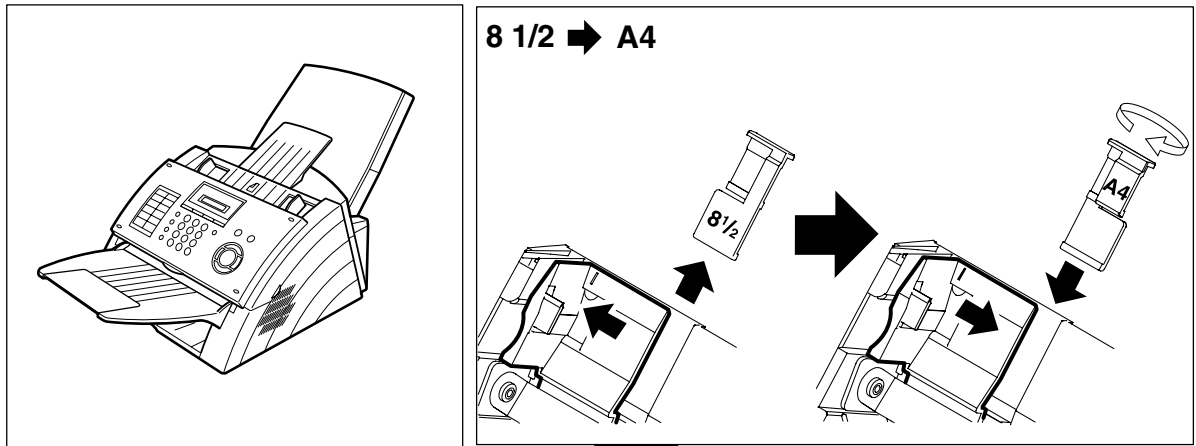

Final Installed View

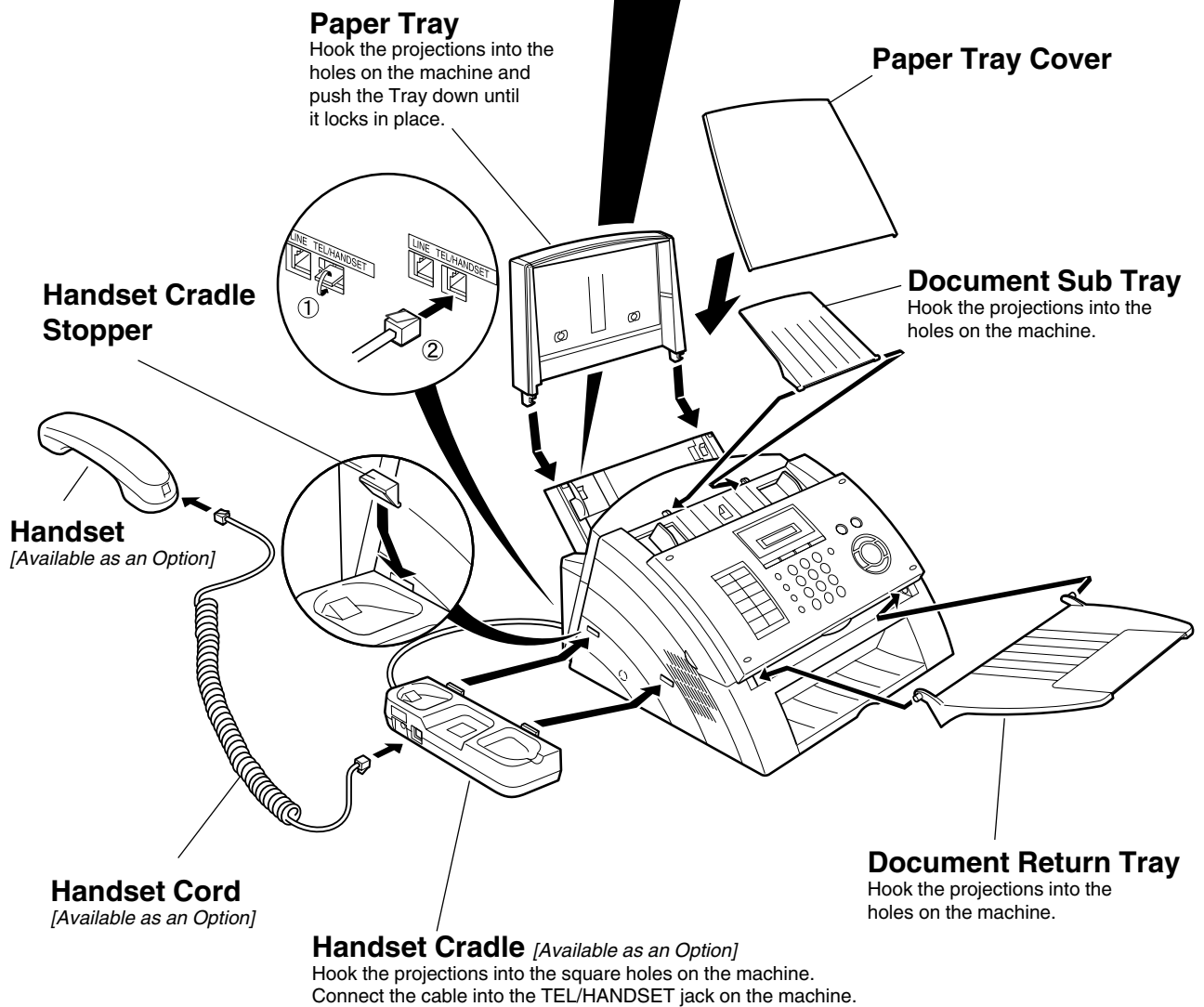

Installing the Drum Unit/Toner Cartridge Assembly

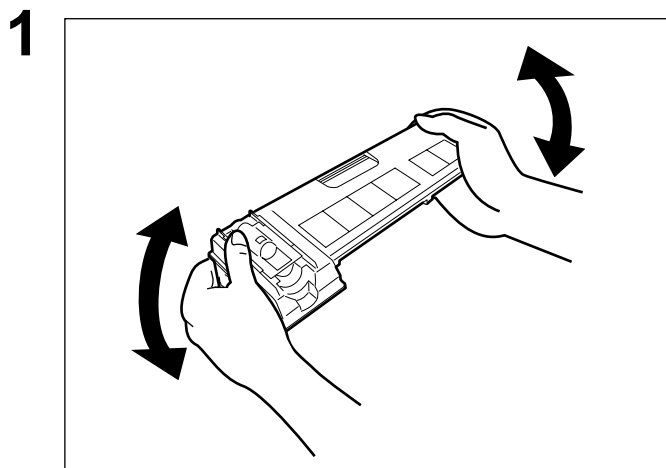

Unpack the Toner Cartridge and rock it back and forth as shown for 5 or 6 times to even the toner inside.

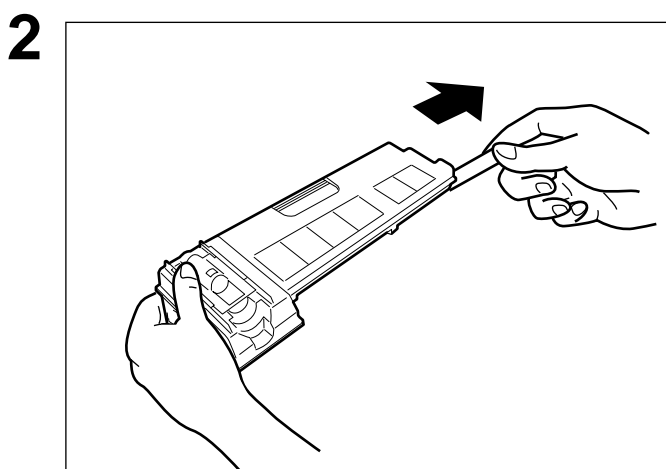

Remove the protective seal.

Note: Pull on the seal slowly and straight out.

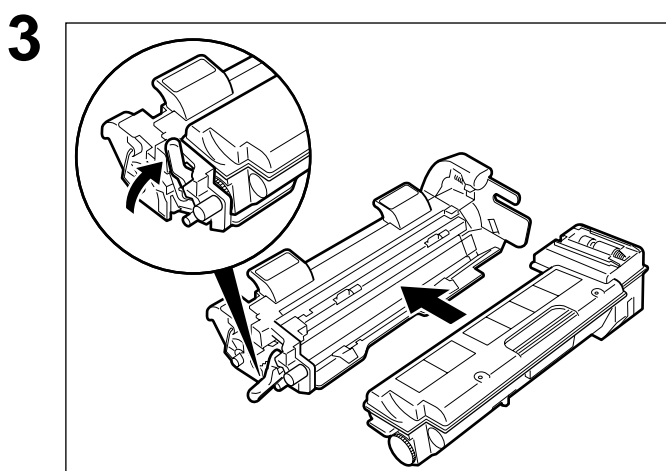

Slide the Toner Cartridge all the way into the Drum Unit and rotate the green lever upwards to lock the Toner Cartridge in place.

Continued on the next page...

Installing the Drum Unit/Toner Cartridge Assembly

4

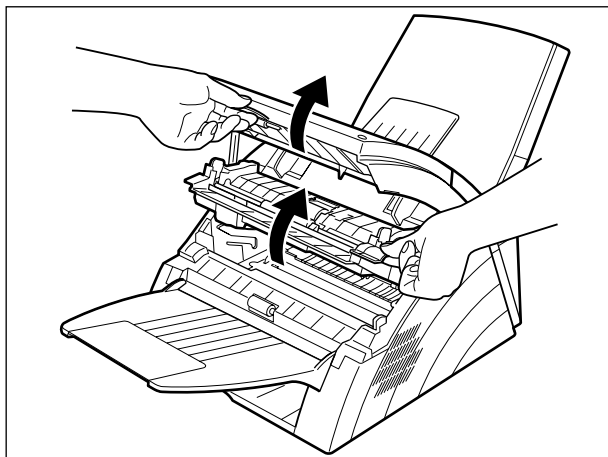

Open the ADF Door and Printer Cover.

5

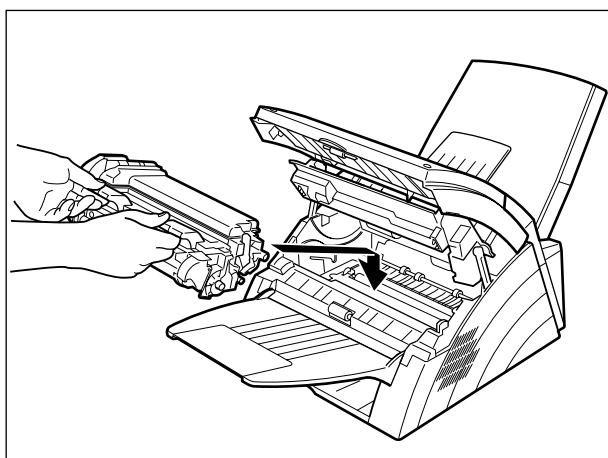

Align the projections on both sides of the Drum Unit/Toner Cartridge Assembly with the grooves in the machine as shown and insert the Drum Unit/Toner Cartridge Assembly into the machine.

6

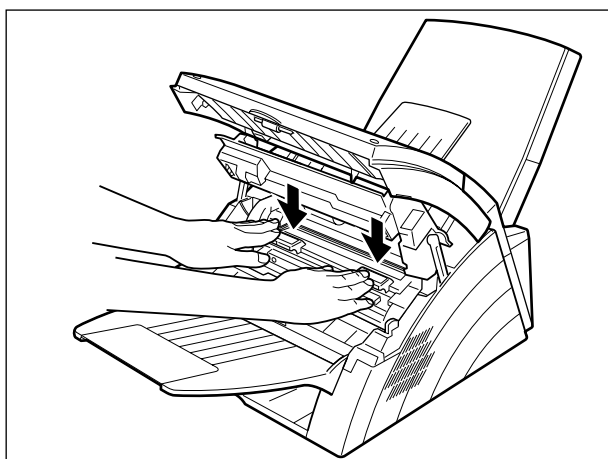

- (1) Push the Drum Unit/Toner Cartridge Assembly down into the machine, snapping it in place.
- (2) Close the ADF Door and Printer Cover

NOTE

1. If you are replacing the Drum Unit or Toner Cartridge, it is recommended to clean the Printer Roller to maintain good printing quality. To clean the Printer Roller, follow the procedure on page 104.
2. When replacing the Drum Unit, press **FUNCTION** (7) (8) **SET** (2) **SET** (1) (1) to reset the notification message.

Loading the Recording Paper

Paper Specifications

In general, most bond papers will produce excellent results. Most photocopy papers will also work very well. There are many "name" and "generic" brands of paper available. We recommend that you test various papers until you obtain the results you are looking for. For detailed recommended paper specifications. (See page 109)

How to Load the Recording Paper

1

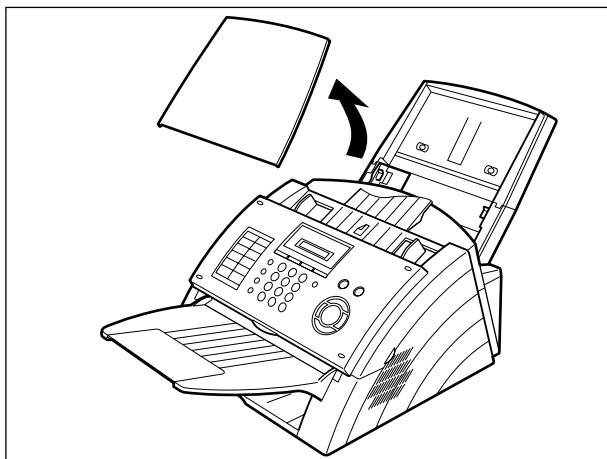

Remove the Paper Tray Cover.

2

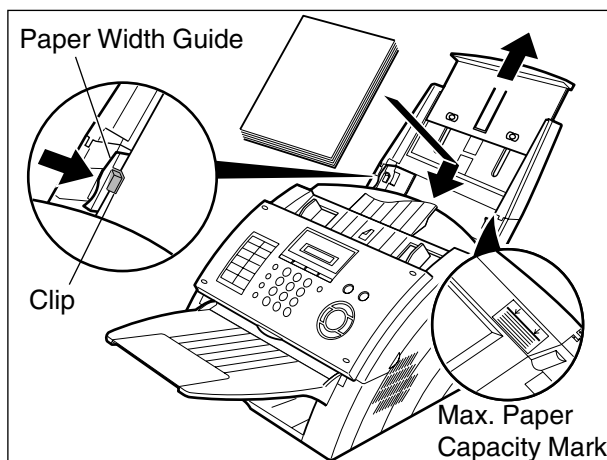

(1) Load the paper into the Paper Tray while pushing the Blue Paper Width Guide to the left.

(2) Verify that the papers are fitted squarely and firmly between the Paper Width Guide and the right side of tray. If it does not, the paper may feed into the printer incorrectly resulting in a paper jam.

Caution: Make sure that the paper is set under the Clips and that it does not exceed the Maximum Paper Capacity Mark. You can load about 150 sheets (20 lb weight).

3

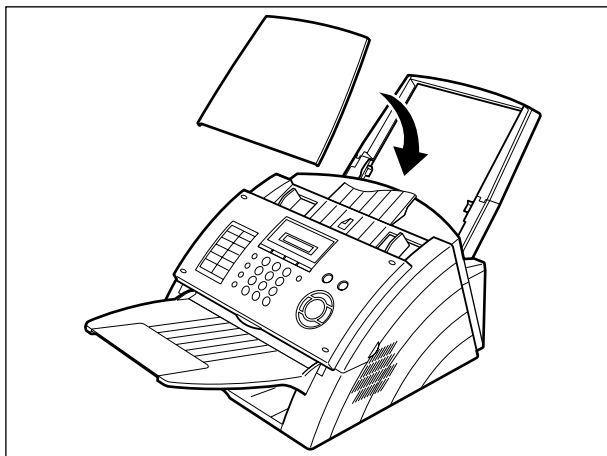

Re-install the Paper Tray Cover.

The Recording Paper Size setting of the Fax Parameter No. 23 must match the paper loaded in the cassette. If you change the Recording Paper Size, please change the setting accordingly. (See page 34)

Connecting the Telephone Line Cable and Power Cord

Power Cord

Plug one end of the power cord into an ordinary 3 prong AC outlet and the other end into the receptacle on the rear of the machine.

Warning: This apparatus must be properly grounded through an ordinary 3 prong AC outlet. Do not break off the earth (ground) prong to fit a 2 prong outlet.

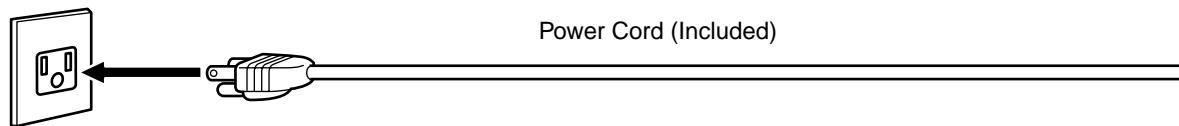

Telephone Line Cable

Plug one end of the telephone line cable into the "RJ-11C" telephone jack supplied by the telephone company and the other end into the LINE jack on the Rear of the machine.

RJ-11C Telephone Jack

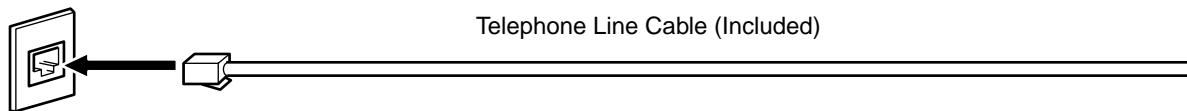

NOTE

1. Your machine uses little power and you should keep it ON at all times. If the power is turned OFF for too long (Over 30 minutes), the clock contents may be lost.

Connecting the Telephone Line Cable and Power Cord

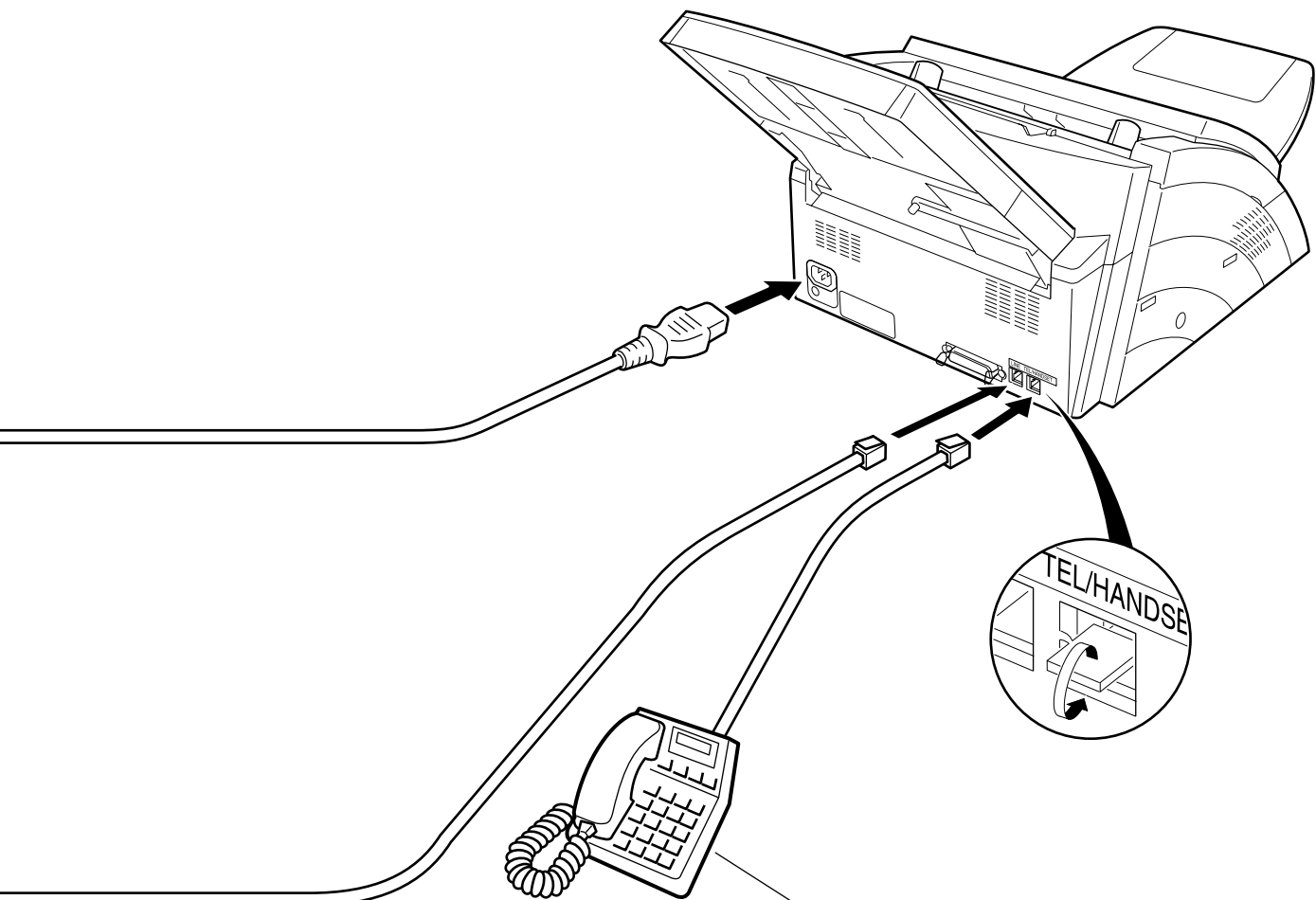

External Telephone (Optional)
You can connect an additional standard single line telephone to the machine.

Setting the Dialing Method (Tone or Pulse)

Your machine can operate with either of two dialing methods (Tone or Pulse), depending on the type of telephone line you are connected to. If you need to change the dialing method to Tone or Pulse, follow the procedure below.

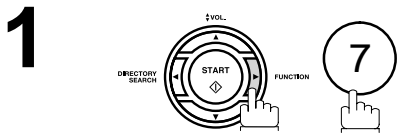

SET MODE (1-8)

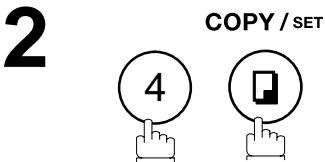

NO. = (01-99)

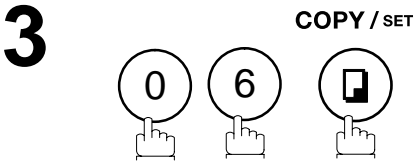

DIALING METHOD?

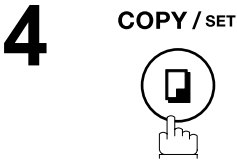

TONE<>

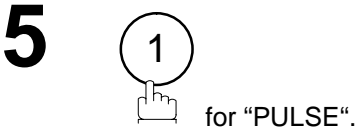

PULSE<>

or

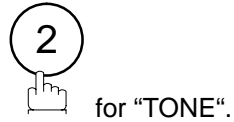

or
TONE<>

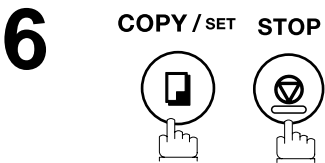

NOTE

1. For some countries, this feature is not available depending on the country's regulation. The display may not show this feature.

Adjusting the Volume

You can adjust the monitor and ringer volume on your machine. The built-in speaker enables you to hear the dial tone, dialing signals, and busy tone. The ringer sounds when your machine receives a call.

Setting the Monitor Volume

1

MONITOR



ENTER TEL NO.

You will hear the dial tone through the speaker.

2

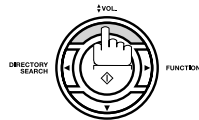

repeatedly to raise the volume.

L [■■■■■■■■] H

or

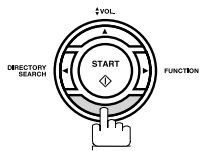

repeatedly to lower the volume.

L [■]] H

3

MONITOR



Setting the Ringer Volume

1

Standby

OCT-12 15:00 00%

2

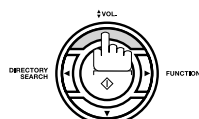

repeatedly to raise the volume.

((☎)) FAX

or

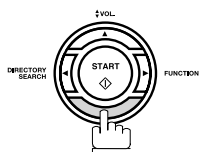

repeatedly to lower the volume.

☎ FAX

3

STOP



NOTE

1. You can also adjust the volume of the key touch tone and the volume of the buzzer in the Fax Parameter No. 10 (KEY/BUZZER VOLUME). (See page 33)

User Parameters

General Description

Your facsimile machine has several basic settings (User Parameters) to help you keep records of the documents you send or receive. For example, the built-in clock keeps the current date and time, and your LOGO and ID Number help to identify you when you send or receive documents.

Setting the Date and Time

At standby the display will show the date and time. Once the standby display is set, it will automatically be updated.

1

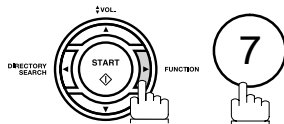

SET MODE (1-8)

2



USER PARAMETERS?

3

COPY / SET



DATE & TIME?

4

COPY / SET



01-01-2001 15:00

5

Enter the new date and time.

Ex: (1) (0) Month : October
(1) (2) Date : 12th
(2) (0) (0) (1) Year : 2001
(1) (5) (0) (0) Time : 3:00 PM

If you make a mistake, use ◀ or ▶ to move the cursor over the incorrect number, then overwrite it with a correct one.

10-12-2001 15:00

6

COPY / SET STOP

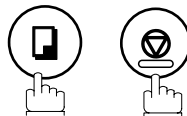

NOTE

1. The clock of your machine is equipped with D.S.T. (Daylight Saving Time) system. So, your clock will automatically set the time forward from 2:00 AM to 3:00 AM on the first Sunday of April and set the time back from 2:00 AM to 1:00 AM on the last Sunday of October. If your state does not use the D.S.T. system, change the Fax Parameter No. 35 (DAYLIGHT TIME) to "Invalid". (See page 34)
2. The current Date & Time must be set because it is required by the Telephone Consumer Act of 1991. (For details, see FCC NOTICE at the end of this Operating Instructions)

Setting Your LOGO (NAME/COMPANY)

When you send a document, your LOGO appears on the top of the copy printed out at the other station. The LOGO helps to identify you to someone who receives your transmission.

1

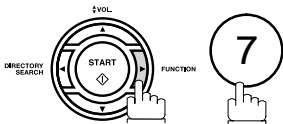

SET MODE (1-8)

2

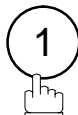

USER PARAMETERS?

3

COPY / SET

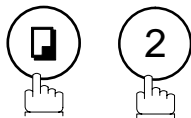

COMPANY/NAME?

4

COPY / SET

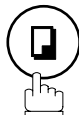

NAME : █

5

Enter your LOGO (max. 25 characters and digits) by using the Keypad.

NAME : PANASONIC █

Ex: P A N A S O N I C

If you make a mistake, use ◀ or ▶ to move the cursor one space beyond the incorrect character, press CLEAR then re-enter the new character.

If more than 11 characters are entered, the left side characters will scroll off the display.

6

COPY / SET STOP

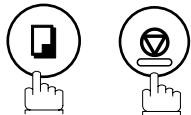

NOTE

1. Your Company Name or your name must be set as your LOGO because it is required by the Telephone Consumer Act of 1991. (For details, see FCC NOTICE at the end of this Operating Instructions)

User Parameters

Setting Your Character ID

If the remote machine has a Character ID capabilities, when you are sending or receiving, your Character ID will appear on the remote machine's display and the remote machine's Character ID will appear on your display.

1

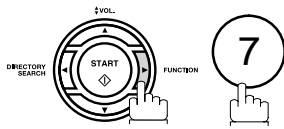

SET MODE (1-8)

2



USER PARAMETERS?

3

COPY / SET

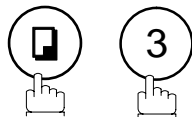

CHARACTER ID?

4

COPY / SET



ID: █

5

Enter your Character ID (max. 16 characters and digits) by using the Keypad.

ID: HEAD OFFICE

Ex: H E A D SPACE O F F I C E

If you make a mistake, use ◀ or ▶ to move the cursor beyond the incorrect character, press CLEAR then re-enter the new character.

6

COPY / SET STOP

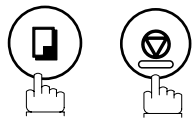

NOTE

1. The special characters of Å, Ä, Ö, Ü, Æ, È, É and Ñ cannot be used for Character ID.

Setting Your ID Number (Fax Telephone Number)

If the remote machine does not have a Character ID but it has an ID Number, when sending or receiving, your ID Number will appear on the remote machine's display and their ID Number will appear on your display.

We suggest you use your facsimile telephone number as your ID number. (Max. 20 digits)

1

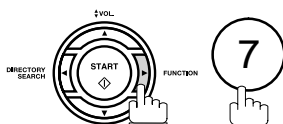

SET MODE (1-8)

2

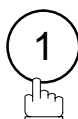

USER PARAMETERS?

3

COPY / SET

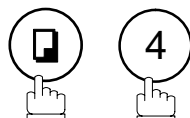

FAX TEL NO. ?

4

COPY / SET



TEL: █

5

Enter your ID (max. 20 digits) by using the keypad and **SPACE** key to enter a space between numbers.

Ex: ② ① ① **SPACE** ⑤ ⑤ ⑤ **SPACE** ① ② ① ②

If you make a mistake, use ◀ or ▶ to move the cursor one space beyond the incorrect number, press **CLEAR** then re-enter the new number.

TEL:01 555 1212 █

6

COPY / SET STOP

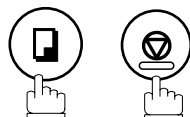













NOTE

- You may use * to enter a "+" character at the beginning of the ID number to indicate the following digit(s) for your country code.
Ex : +1 201 555 1212 +1 for U.S.A. country code.
 +81 3 111 2345 +81 for Japan country code.
- Your Fax Telephone Number must be set as your ID Number because it is required by the Telephone Consumer Act of 1991. (For details, see FCC NOTICE at the end of this Operating Instructions)

Entering Characters

The Keypad also serves as character and symbol input key when recording LOGO, Character ID and station name. Select the desired characters according to the following table

Keys	Character Table												
	Number of times key is pressed												
	1	2	3	4	5	6	7	8	9	10	11	12	13
	Å	Ä	Ö	Ü	È	É	Æ	Ñ	1				
	A	B	C	a	b	c	2						
	D	E	F	d	e	f	3						
	G	H	I	g	h	i	4						
	J	K	L	j	k	l	5						
	M	N	O	m	n	o	6						
	P	Q	R	S	p	q	r	s	7				
	T	U	V	t	u	v	8						
	W	X	Y	Z	w	x	y	z	9				
	-	/	()	.	,	'	:	;	&	+	=	0
	*												
	#												

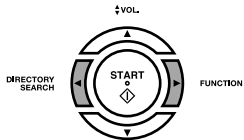
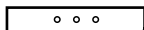
Keys	Special Usage
ABBR / SPACE 	Enters a SPACE.
	Moves the cursor to the right and left.
CLEAR 	Deletes a character.

One-Touch/Abbreviated Dialing Numbers

Entering One-Touch/Abbreviated Dialing Numbers

One-Touch and Abbreviated Dialing are two fast ways of dialing full telephone numbers. To use these dialing methods, you must first store the telephone number using the following procedure.

To enter a One-Touch key, follow the steps below

1

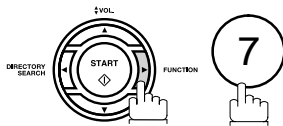

SET MODE (1-8)

2

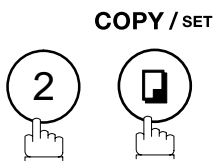

1:ONE-TCH 2:ABBR

3



PRESS ONE-TOUCH

4

Ex:  (See Note 1)

<01>ENTER TEL.#

5

Enter the telephone number
(up to 36 digits including pauses and spaces).

Ex: 

<01>9-555 1234

6

COPY / SET

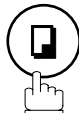

<01>ENTER NAME

7

Enter the station name using the Keypad
(up to 15 characters).

Ex: 

<01>SALES DEPT

8

COPY / SET

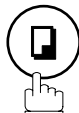

PRESS ONE-TOUCH

To record another number, repeat Steps 4 to 8.

To return to standby, press .





NOTE

1. Use  to select either an upper or lower One-Touch key.

One-Touch/Abbreviated Dialing Numbers

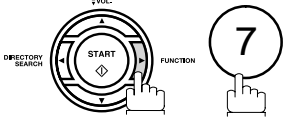
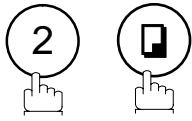
Entering One-Touch/Abbreviated Dialing Numbers

To set an Abbreviated Dialing Number, follow the steps below

- 1**  SET MODE (1-8)
 - 2** **COPY / SET**  1:ONE-TCH 2:ABBR
 - 3**  ABBR. NO.=■
 - 4** **Ex:** ② ② (01 to 82) [22]ENTER TEL.#
 - 5** Enter the telephone number (up to 36 digits including pauses and spaces).
Ex: ⑨ [PAUSE] ⑤ ⑤ ⑤ [SPACE] ② ③ ④ ⑤ [22]9-555 2345■
 - 6** **COPY / SET**  [22]ENTER NAME
 - 7** Enter the station name using the Keypad (up to 15 characters).
Ex: [A][C][C][O][U][N][T][I][N][G] [22]ACCOUNTING
 - 8** **COPY / SET**  ABBR. NO.=■
- To record another number, repeat Steps 4 to 8.
To return to standby, press [STOP].

NOTE

1. If you require a special access number to get an outside line, enter it first and then press [PAUSE]. A hyphen "-" is displayed for pause.
2. If you are using Pulse dialing and you wish to change to Tone dialing in the middle of dialing, press [TONE] (represented by a "/"). The dialing method will be changed from Pulse to Tone after dialing the digit "/".
Ex: 9 PAUSE TONE 5551234
3. You can search for an unused One-Touch key or ABBR. number by pressing ▲ or ▼ in Steps 3 or 4.

One-Touch/Abbreviated Dialing Numbers

Editing One-Touch/Abbreviated Dialing Numbers

If you have to change or erase any of the One-Touch/Abbreviated dialing numbers, follow the steps below.

To change the settings of a One-Touch/ABBR dialing number

1

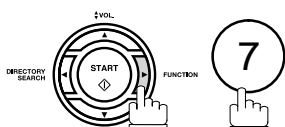

SET MODE (1-8)

2

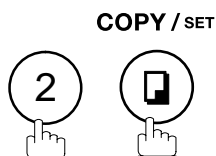

1:ONE-TCH 2:ABBR

3

Press ① for One-Touch Dialing Number.

Press ② for ABBR. Dialing Number.

Ex: ①

PRESS ONE-TOUCH

4

Enter the station you wish to change.

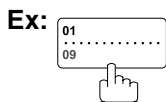

<01>_9-555 1234

5

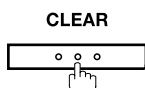

<01>_ENTER TEL.#

then enter a new telephone number. (See Note 1)

Ex: ⑨ PAUSE ⑤ ⑤ ⑤ SPACE ③ ④ ⑤ ⑥

<01>9-555 3456

6



<01>_SALES DEPT

7

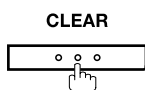

<01>_ENTER NAME

then enter a new station name. (See Note 1)

Ex: P L A N N I N G

<01>_PLANNING

8



PRESS ONE-TOUCH

To return to standby, press STOP.

NOTE

- If you make a mistake, use ◀ or ▶ to move the cursor one space beyond the incorrect number, press CLEAR then re-enter the new number.

One-Touch/Abbreviated Dialing Numbers

Editing One-Touch/Abbreviated Dialing Numbers

To erase the settings of a One-Touch/ABBR dialing number

1

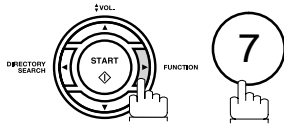

SET MODE (1-8)

2

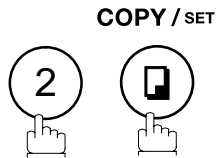

1:ONE-TCH 2:ABBR

3

Press ① for One-Touch Dialing Number.
Press ② for ABBR. Dialing Number.

Ex: ①

PRESS ONE-TOUCH

4

Enter the station you wish to erase.

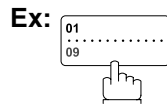

<01>9-555 1234

5

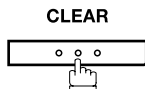

<01>ENTER TEL.#

6



PRESS ONE-TOUCH

To return to standby, press **STOP**.

NOTE

1. If you make a mistake, use ◀ or ▶ to move the cursor one space beyond the incorrect number, press **CLEAR** then re-enter the new number.

One-Touch/Abbreviated Dialing Numbers

Printing Out a Directory Sheet

After programming a one-touch dialing number, you can print out the directory sheet which includes the first 12 characters of each station name. Cut along the dotted line and place it over the One-Touch keys under the Directory Sheet Cover. To print out a directory sheet, follow the steps below.

1

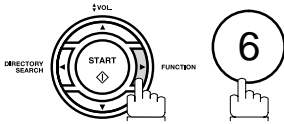

PRINT LIST (1-7)

2

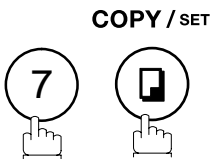

* PRINTING *

Your machine prints out the directory sheet.

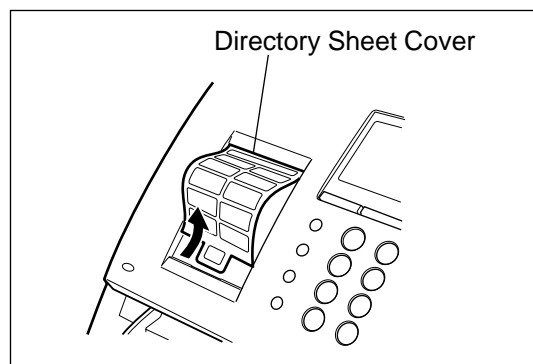
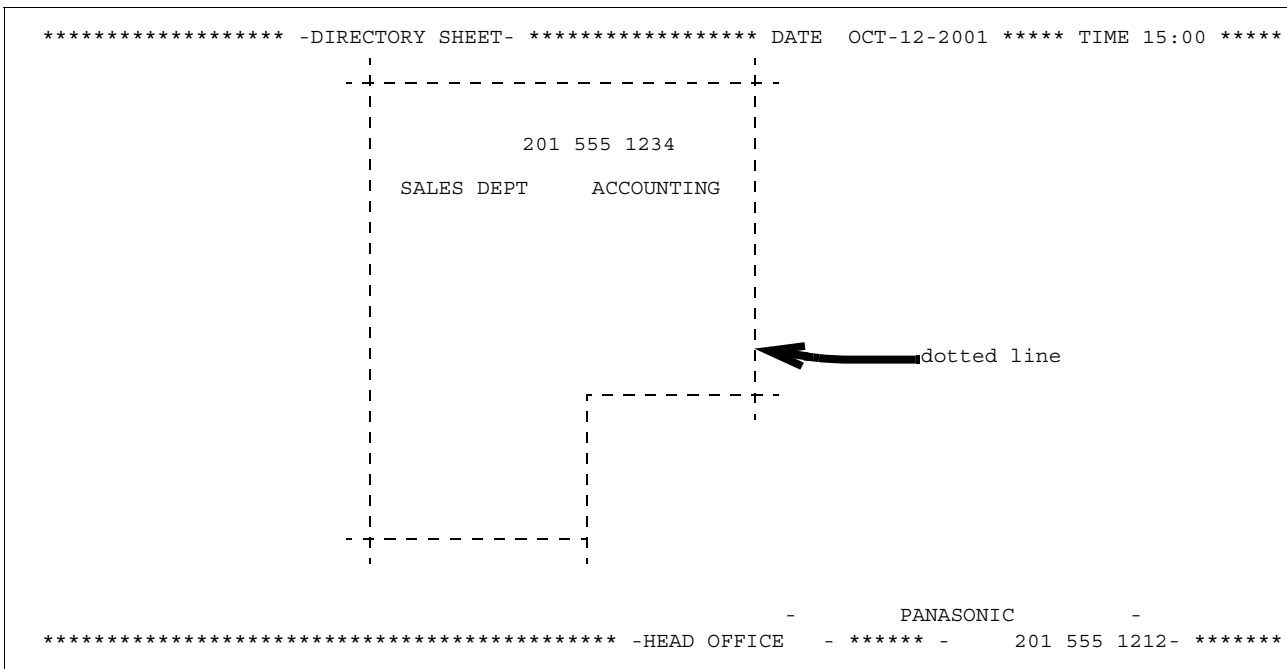

Customizing Your Machine

General Description

Your facsimile machine has a variety of adjustable Fax Parameters. These parameters, listed in the Parameter Table, are preset for you and do not need to be changed. If you do want to make a change, read the table carefully. Some parameters, such as the Resolution and Contrast parameters, can be temporarily changed by simple key operation just before a transmission is made. When the transmission ends, however, these parameters return to their preset values (Home position). Other parameters can only be changed by the procedure described below.

Setting the Fax Parameters

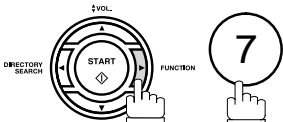
- 

1

SET MODE (1-8)
 - 2**

COPY / SET

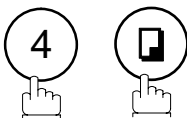

NO. = (01-99)
 - 3**

Enter Fax Parameter number from the Parameter Table.
Ex: ① for **CONTRAST**

NO. =01 (01-99)
 - 4**

COPY / SET COPY / SET

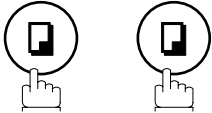

NORMAL<>
 - 5**

Enter the new setting value or press ◀ ▶.Ex: ② for **LIGHTER**

LIGHTER<>
 - 6**

COPY / SET



RESOLUTION?
- To set another parameter, press **CLEAR** to return to Step 3 or press **STOP** to return to standby.

NOTE

- To scroll the Fax Parameters in Step 2, press ▼ or ▲.
- To print out a Fax Parameter List, see page 92.

Fax Parameter Table

No.	Parameter	Setting Number	Setting	Comments
01	CONTRAST	*1	Normal	Setting the home position for the CONTRAST.
		2	Lighter	
		3	Darker	
02	RESOLUTION	*1	Standard	Setting the home position for the RESOLUTION.
		2	Fine	
		3	S-Fine	
		4	Halftone	
05	MEMORY	1	Off	Setting the home position for memory transmission/copy mode. (This setting can be temporarily changed by pressing FUNCTION, 8, 9.)
		*2	On	
06	DIALING METHOD	1	Pulse	Selecting the dialing method.
		*2	Tone	
07	HEADER PRINT	*1	Inside	Selecting the printing position of the header. Inside : Inside TX copy area. Outside : Outside TX copy area. No print : Header is not printed.
		2	Outside	
		3	No print	
08	HEADER FORMAT	*1	Logo, ID No.	Selecting the header format.
		2	From To	
09	RCV'D TIME PRINT	*1	Invalid	Selecting whether the machine prints the received date & time, remote ID, percentage of reduction and page number on the bottom of each received document.
		2	Valid	
10	KEY/BUZZER VOLUME	1	Off	Selecting the volume of the Key/Buzzer tone.
		*2	Soft	
		3	Loud	
12	COMM. JOURNAL	1	Off	Selecting the home position of printout mode for COMM. Journal Off/Always/Inc. only. Off : Does not print Always : Always prints Inc. only : Prints only when communication has failed.
		2	Always	
		*3	Inc. only	
13	AUTO JOURNAL PRINT	1	Invalid	Selecting whether the machine prints the journal automatically after every 32 transactions.
		*2	Valid	
15	IN MODE	*1	Tel	Selecting IN (attended) mode as either Telephone Mode or Fax/Tel Auto Switching Mode.
		2	Fax/Tel SW	
16	OUT MODE	*1	Fax	Selecting OUT (unattended) mode as either Fax Mode or TAM Interface Mode.
		2	TAM / Fax	
18	OPERATOR CALL TIMER	*1	20 sec.	Selecting the length of time that your machine signals (rings) for an incoming voice call in Fax/Tel Auto Switching Mode. (See page 58)
		2	30 sec.	
		3	40 sec.	
		4	50 sec.	
19	OGM LENGTH (TAM I/F)	1	1 sec.	Setting for the OGM length of your TAM from 1 to 60 seconds. The machine will not start to detect SILENCE until the time setting has lapsed. (Default = 20 sec.)
		---	---	
		60	60 sec.	
20	SILENT DETECTION (TAM I/F)	1	Invalid	Selecting the Silent Detection Mode.
		*2	Valid	

Continued on the next page...

Customizing Your Machine

Fax Parameter Table

No.	Parameter	Setting Number	Setting	Comments
22	SUBSTITUTE RCV	1	Invalid	Selecting whether the machine receives to memory when the recording paper runs out, toner runs out or the recording paper is jammed.
		*2	Valid	
23	RECORDING PAPER SIZE	1	A4	Setting the recording paper size installed in your machine.
		*2	Letter	
		3	Legal	
24	PRINT REDUCTION	1	Fixed	Selecting print reduction mode. Fixed :Reduce received document according to setting of Parameter No. 25. Auto : Reduce received document according to the length of received documents.
		*2	Auto	
25	REDUCTION RATIO	70	70%	Selecting the fixed print reduction ratio from 70% to 100%. This parameter functions only when the fixed print reduction is selected on Fax Parameter No. 24.
		----	----	
		100	100%	
26	POLLING PASSWORD		(----	Setting a 4-digit password for secured polling. (See page 66)
32	COPY REDUCTION	1	Manual	Selecting whether the machine performs the copy reduction ratio automatically or manually. Manual : The machine will prompt you for the Zoom ratio (100% to 70%) when making copies. Auto : The machine will automatically determine the reduction ratio according to the length of the original document.
		*2	Auto	
34	ENERGY SAVER MODE	1	Off	To reduce the power consumption in standby, select either Energy-Saver or Sleep mode and specify the Delay Time (1 to 120 minutes) for the machine to enter into the selected mode. The Delay Timer setting is only available in the Energy-Saver or Sleep Modes. Off : The unit will remain in standby mode and consume more energy than when in Energy-Saver or Sleep modes. Energy-Saver Mode : Saves energy by consuming less power than when in standby mode by turning off the fuser unit after the specified time. Sleep Mode : This is the lowest power state that the machine enters after the specified time without actually turning off.
		2	Energy-Saver	
		*3	Sleep	
35	DAYLIGHT TIME	1	Invalid	Selecting whether the clock adjusts for Daylight Saving Time automatically. The built-in clock will advance 1 hour at 2:00 am on the first Sunday in April and fallback 1 hour at 2:00 am on the last Sunday in October.
		*2	Valid	
36	RING PATTERN DETECT (DRD) (See Note 2)	*1	Invalid	All ring patterns.
		2	Valid	Select a ring pattern for automatic answering. 1 : A Standard ring pattern. 2 : B Double ring pattern. 3 : C Triple ring pattern (Short-Short-Long). 4 : D All other triple ring patterns, except the type C described above.

Fax Parameter Table

No.	Parameter	Setting Number	Setting	Comments
38	ACCESS CODE		(----	Enter a 4-digit Access Code to secure the machine from unauthorized use. (See page 73)
39	PIN CODE ACCESS	*1	None	Selecting the access method (Prefix or Suffix) to dial a number with PIN Code. (See page 76)
		2	Suffix	
		3	Prefix	
47	REMOTE RECEPTION	1	Invalid	Selecting whether or not the machine accepts the remote reception command. (See page 57)
		*2	Valid	
51	REMOTE DIAGNOSTIC	1	Invalid	Selecting whether or not the machine accepts to update the firmware or Remote Diagnostics from the remote station. Please ask your Panasonic Authorized Dealer for details.
		*2	Valid	
52	DIAGNOSTIC PASSWORD		(----	Setting the password for Remote Diagnostic Mode. Please ask your Panasonic Authorized Dealer for details.
53	SUB-ADDRESS PASSWORD		(----	Setting a 20-digit password for secured sub-address communication.
54	FAX FORWARD	*1	Invalid	Selecting whether the machine performs Fax Forwarding to the specified destination. (See page 78)
		2	Valid	
58	LANGUAGE	*1	A-English	Selecting the language to be shown on the display and reports.
		2	C-French	
		3	Spanish	
63	PC-FAX RCV MODE	*1	Print	Selecting how the machine will execute the received Fax document(s). If the setting is set to either "Upload" or "Upload & Print" the machine cannot enter the Sleep Mode. Print : Print the received document(s). Upload & Print : Print the received document(s) and upload it's file. Upload : Upload the received document file.
		2	Upload & Print	
		3	Upload	
65	PRINT COLLATION	1	Invalid	Selecting whether the machine prints out documents in sequence. (See page 63)
		*2	Valid	
80	SELF MAINTENANCE TIME	00:00 - 23:00 (*12:00)		Setting the hour to activate the Scanning Roller Maintenance. The Scanning Roller will be rotated for a few seconds at the set hour. This is to keep smooth contact between the Scanning Roller and the Scanning Glass.
99	MEMORY SIZE	-	-	Displays the memory size.

NOTE

1. Setting number marked with an asterisk (*) indicates the factory standard setting.
2. This parameter supports an optional telephone service "Distinctive Ring Service" provided by your local telephone company. It allows up to 4 different telephone numbers to be assigned on a single telephone line with a distinctive ring for each telephone number. By selecting the appropriate ring pattern associated with the telephone number assigned for your fax machine. It can differentiate and answer the incoming call on the fax number. All other calls on the other telephone numbers will not be answered. This optional service from your local phone company is also called Custom Ringing, Distinctive Ringing, Ident-a-call, Ident-a-ring, Personalized Ringing, RingMaster, RingMate, Selective Ringing, Smart Ring or something similar. Check with your local telephone company on the availability of this service in your area.

Loading Documents

Documents You Can Send

In general, your machine will send any document printed on A4, Letter or Legal size paper.

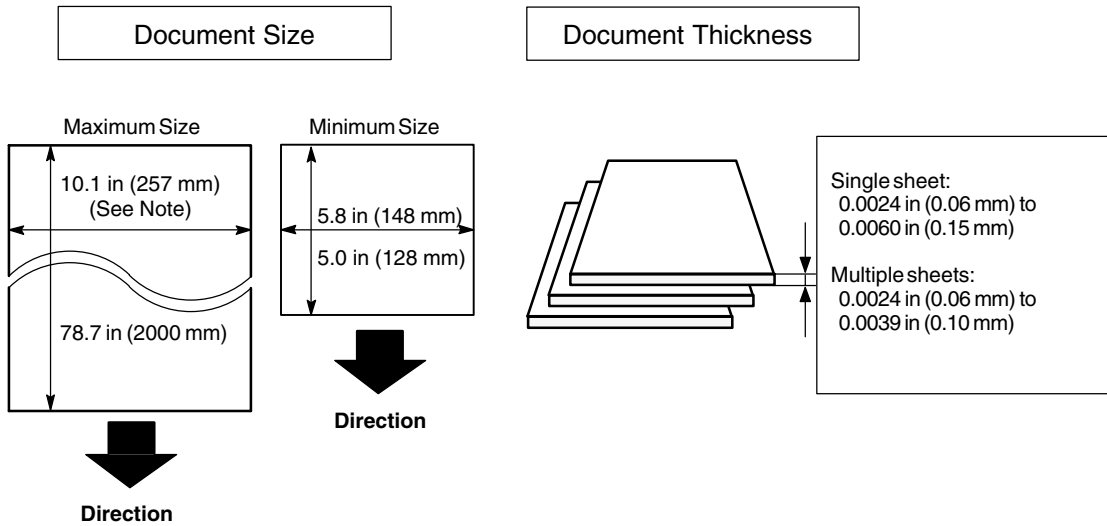

Note: The maximum document width that can be sent through the machine is 10.1 in (257mm). However, the effective scanning width is 8.3 in (212mm)

Documents You Cannot Send

You must never try to send documents that are:

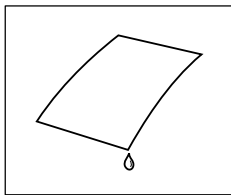
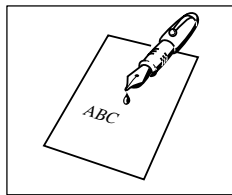
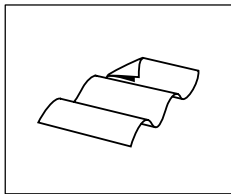
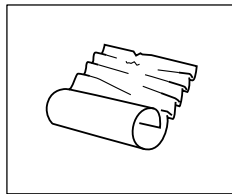
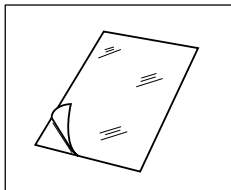
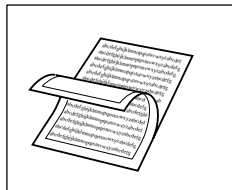
	Wet		Covered with wet ink or paste
	Too thin (e.g., onionskin, airmail paper, pages from some magazines, etc.)		Wrinkled, curled or folded
	Coated (e.g., glossy paper, etc.)		Chemically processed (e.g., pressure-sensitive paper, carbon-coated paper, etc.) or made of cloth or metal

To transmit these kinds of documents, make a photocopy first and then transmit the copy instead.

How to Load Documents

1. Be sure the document(s) is free of staples, paper clips and is not torn, greasy or covered by foreign objects.
2. Place the document(s) **FACE DOWN** on the Automatic Document Feeder (ADF) until the leading edge placed into the machine stops.
If you are sending multiple pages, make sure that **the bottom sheet enters first**. You can also stack **up to 20 PAGES** on the ADF at one time. If you have more than 20 pages, wait until transmission or storing in memory starts as pages feed through, place any remaining pages on top of the last page in the feeder.
3. Adjust the Document Guides to center the document on the ADF.

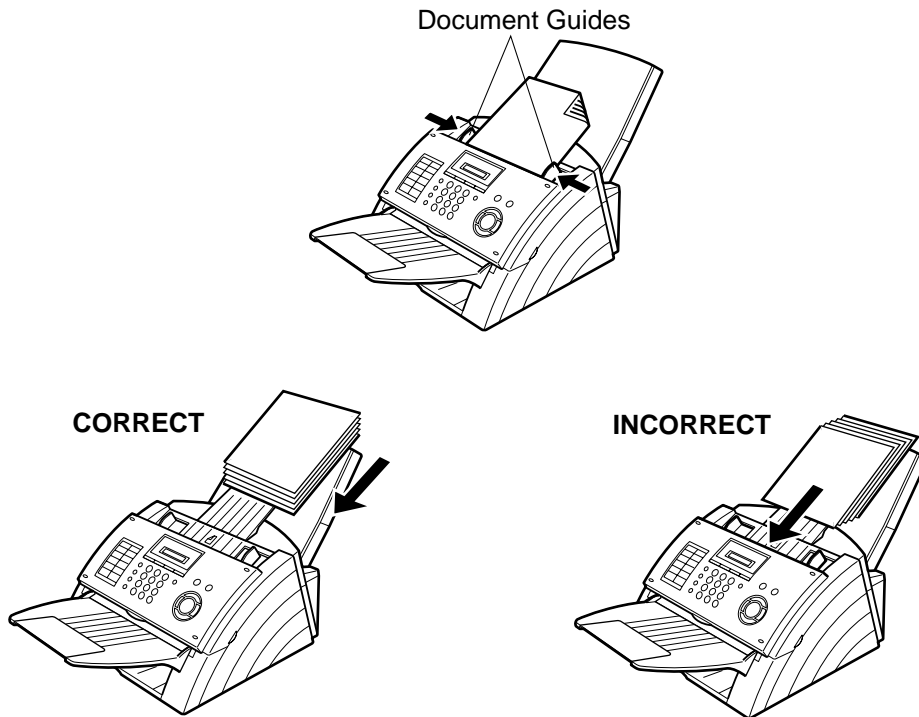

When you set a document on the ADF, the display message will change from date and time (standby) to the following message. You can now change basic transmission settings, or begin the dialing procedure.

DOCUMENT SET

NOTE

1. Transmitting documents longer than 14 in (356 mm) requires user's assistance.

Basic Transmission Settings

General Description

You can temporarily change the transmission settings either before or after you place the document on the ADF.

These settings are as follows

- Contrast
- Resolution
- Communication Journal

After your document(s) have been sent, your machine will automatically return to the preset settings.

Contrast

Your machine is preset to **Normal** contrast. If you wish to send a document with lighter contrast, change the setting to **Lighter**. If you wish to send a document with darker contrast, change the setting to **Darker**.

Press **CONTRAST** to:

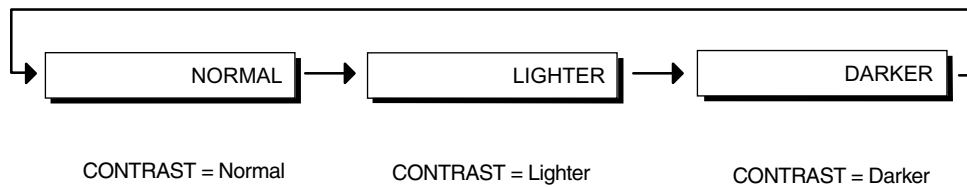

Resolution

Your machine is preset to **Standard** resolution, which is suitable for most documents.

If you want to send it with more detail, change the setting to **Fine**, **Super Fine** or **Halftone**.

Press **RESOLUTION** to:

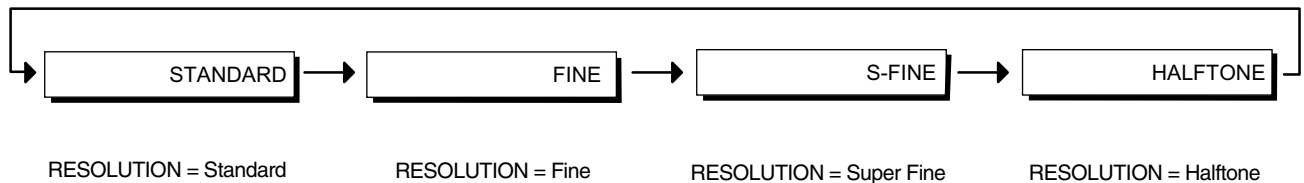

NOTE

1. To change the preset Contrast position, change the setting of Fax Parameter No. 01. (See page 33)
2. To change the preset Resolution position, change the setting of Fax Parameter No. 02. (See page 33)

Communication Journal (COMM. JOURNAL)

A Communication Journal lets you verify if the transmission was successful. You can select the condition to print out the Communication Journal as follows.

When COMM. JOURNAL = **OFF** : a Communication Journal will not print.

When COMM. JOURNAL = **ON** : a Communication Journal will print automatically after every communication.

When COMM. JOURNAL = **INC.** : a Communication Journal will print only if the communication has failed.

1

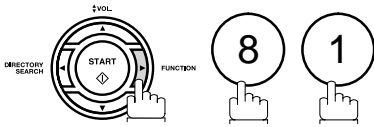

COMM. JOURNAL?

2

COPY / SET



INC<>

3



for "OFF".

or



for "ON" (Always prints).

or



for "INCOMPLETE" only.

OFF<>

ON<>

INC<>

4

COPY / SET



NOTE

1. To change the preset Comm. Journal condition, change the setting of Fax Parameter No. 12. (See page 33)

Sending Documents

General Description

You can choose either Memory or Direct Transmission.

Use Memory Transmission if:

- You want to send the document(s) to multiple stations.
- You have to retrieve the document immediately.
- You want to take advantage of Dual the Operation design.

Use Direct Transmission if:

- The memory is full.
- You want to send the document(s) immediately.

Use Voice Mode Transmission if:

- You want to send the document(s) after talking with the other party first.
- You want to send the document(s) after listening to a voice prompting.

Memory Transmission

Your machine quickly stores the document(s) into the machine's memory. Then, starts to dial the telephone number. If the transmission fails, your machine will re-transmit the remaining unsuccessful page(s) automatically.

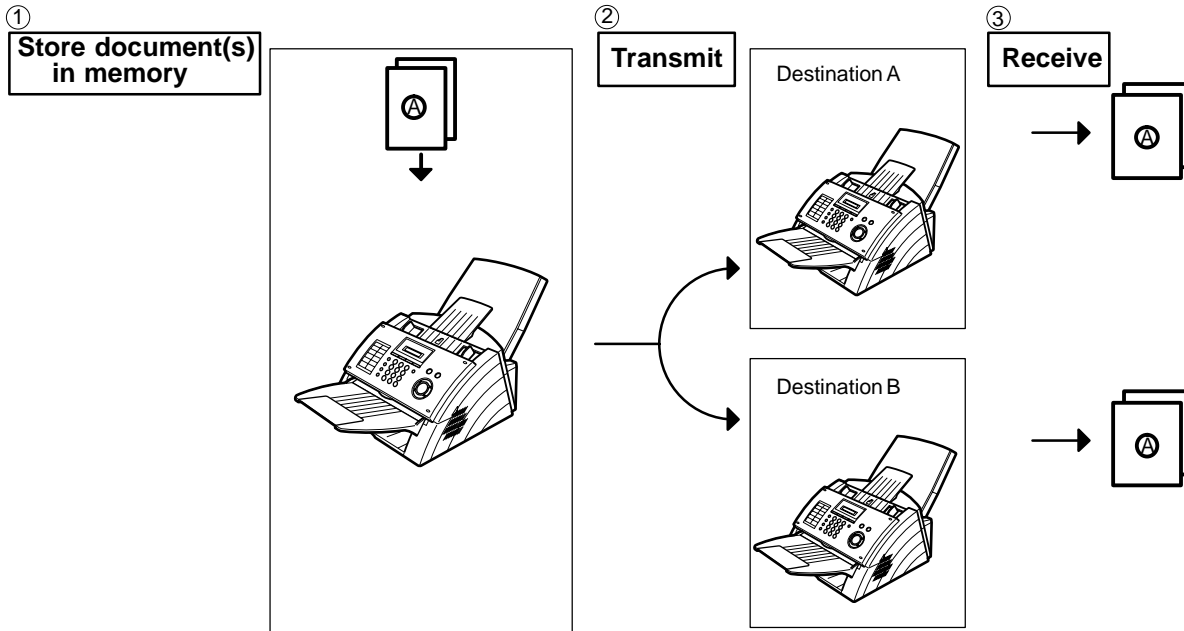

NOTE

- If memory overflow occurs while storing document(s), the remaining document(s) on the ADF will be ejected. The machine prompts you whether to transmit the successfully stored document(s) or to cancel the transmission. Press ① to cancel or press ② to transmit.

COMPLETED=XXX PG

See the Specifications on page 108 for the image memory capacity.

If no action is taken within 10 seconds, the machine will start transmitting the stored document(s).

- To stop the transmission, press STOP.

The display shows:

COMM. STOP?

Press SET and ① to stop the transmission. The document(s) you stored will be erased automatically.

- If you would like to print a Communication Journal (COMM. JOURNAL) after stopping a transmission, the display shows:

PRINT COMM. JRNL?

Press SET and ① to print a Communication Journal.

- If the file memory capacity reaches 5 files and you try to store another file, the following display appears and the machine will not accept additional files until a file is completed and becomes available.

FILE FULL

Sending Documents

Memory Transmission

Manual Number Dialing

To dial the telephone number manually, follow the steps below.

1



Set document(s) face down.

DOCUMENT SET

2

Enter a telephone number from the Keypad.
(Up to 36 digits)

You can also designate more than one destination.

5551234

Ex: ⑤ ⑤ ⑤ ① ② ③ ④

3

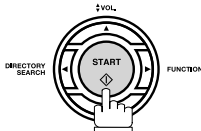

The document(s) begin to store into memory.
Then starts dialing the telephone number.

* STORE * 05%

NOTE

1. If you need a special access number to get an outside line, dial it first then press **PAUSE** to enter a pause (represented by a "-") before dialing the full number.

Ex: 9 PAUSE 5551234

2. If you are using Pulse dialing and you wish to change to Tone dialing in the middle of dialing, press **TONE** (represented by a "/").

The dialing mode will be changed from Pulse to Tone after dialing the digit "/".

Ex: 9 PAUSE TONE 5551234

Memory Transmission

One-Touch Dialing

One-Touch Dialing allows you to dial a full telephone number by pressing a single key. To set up the One-Touch keys, see page 27.

1



Set document(s) face down.

DOCUMENT SET

2

Press a One-Touch key (01 - 16).

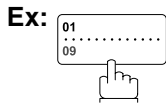

<01> Station name

3

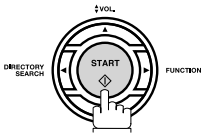

The document(s) begin to store into memory. Then starts dialing the telephone number.

* STORE * 05%

Abbreviated Dialing

Abbreviated dialing is a speedy way to dial a frequently dialed telephone number by preprogramming the telephone number into the built-in auto-dialer with a 2-digit abbreviated code. To program an abbreviated dialing number, see page 28.

1



Set document(s) face down.

DOCUMENT SET

2

Press ABBR then enter a 2-digit code.

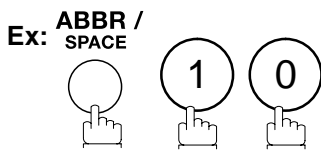

[10] Station name

3

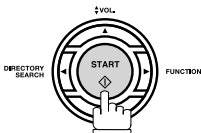

The document(s) begin to store into memory. Then starts dialing the telephone number.

* STORE * 05%

Sending Documents

Memory Transmission

Directory Search Dialing

Directory Search dialing allows you to dial a full telephone number by searching the station name entered in One-Touch keys or Abbreviated dialing numbers.

1



Set document(s) face down.

DOCUMENT SET

2

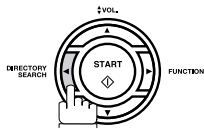

ENTER LETTER(S)

3

Enter the full station name or part of a station name by using the Keypad.

SA

Ex: [S] [A] for searching SALES DEPT

4

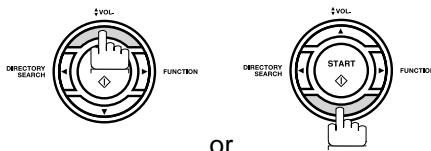

or

repeatedly until the display shows the station name you want to send to.

[10] SALES DEPT

5

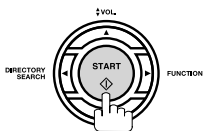

The document(s) begin to store into memory. Then starts dialing the telephone number.

* STORE * 05%

Memory Transmission

Multi-Station Transmission (Broadcasting)

If you have to send the same document(s) to multiple stations, you can save time in feeding the document(s) by using memory transmission. That is, you can store the document(s) into memory and then send it to the station(s) automatically.

1



Set document(s) face down.

DOCUMENT SET

2

Dial by any combination of the following methods:

- One-Touch Dialing
- Abbreviated Dialing
- Manual Number Dialing, press SET after each station is entered (up to 7 stations)
- Directory Search Dialing, press SET after each station is entered (For details, see pages 42 to 44.)

Ex:

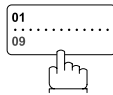

ABBR / SPACE

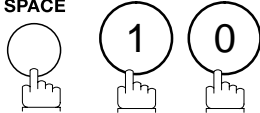

If you want to confirm the number of stations you have entered, press SET.

<01> Station name

[10] Station name

002 STN(S) SET

3

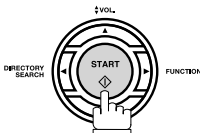

The document(s) begin to store into memory. Then starts dialing the telephone numbers in sequence.

* STORE * 05%

NOTE

1. You can review the stations you entered in Step 3 before storing your document(s) into memory by pressing ▼ or ▲. Press CLEAR to clear an entered station or group shown on the display if needed.

Sending Documents

Direct Transmission

If your machine's memory is full or you wish to send the document(s) immediately, use Direct Transmission.

Manual Number Dialing (Direct Transmission)

To dial the telephone number manually, follow the steps below.

1



Set document(s) face down.

DOCUMENT SET

2

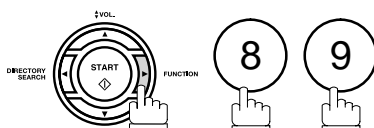

MEMORY XMT?

3

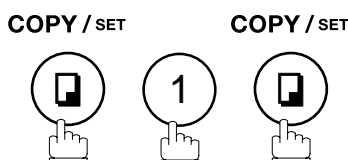

DOCUMENT SET

4

Enter a telephone number from the Keypad.

Ex: ⑤ ⑤ ⑤ ① ② ③ ④

5551234

5

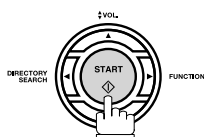

Your machine starts dialing the telephone number.

NOTE

1. If you need a special access number to get an outside line, dial it first then press **PAUSE** to enter a pause (represented by a "-") before dialing the full number.
Ex: 9 PAUSE 5551234
2. If you are using Pulse dialing and you wish to change to Tone dialing in the middle of dialing, press **TONE** (represented by a "/").
The dialing mode will be changed from Pulse to Tone after dialing the digit "/".
Ex: 9 PAUSE TONE 5551234
3. To stop the transmission, press **STOP**.
The display shows:

COMM. STOP?

Press **SET** and ① to stop the transmission.

Direct Transmission

One-Touch Dialing (Direct Transmission)

One-Touch Dialing allows you to dial a full telephone number by pressing a single key. To set up the One-Touch keys, see page 27.

1



Set document(s) face down.

DOCUMENT SET

2

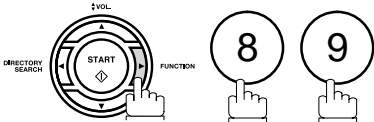

MEMORY XMT?

3

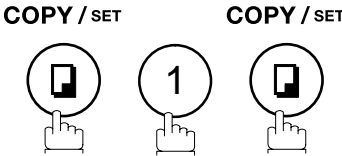

DOCUMENT SET

4

Press a One-Touch key (01 - 16).

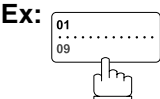

<01> Station name

The display will show the One-Touch number and station name. The full number will then be dialed.

Sending Documents

Direct Transmission

Abbreviated Dialing (Direct Transmission)

Abbreviated dialing is a speedy way to dial a frequently dialed telephone number by preprogramming the telephone number into the built-in auto-dialer with a 2-digit abbreviated code. To program an abbreviated dialing number, see page 28.

1



Set document(s) face down.

DOCUMENT SET

2

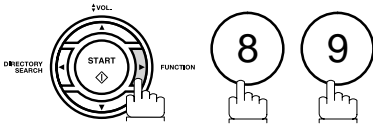

MEMORY XMT?

3

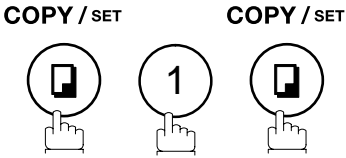

DOCUMENT SET

4

Press **ABBR** then enter a 2-digit code.

[10] Station name

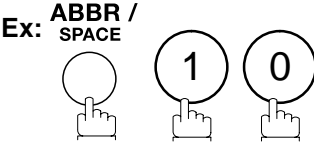

The display will show the ABBR number and station name.
The full number will then be dialed.

Direct Transmission

Directory Search Dialing (Direct Transmission)

Directory Search dialing allows you to dial a full telephone number by searching the station name entered in One-Touch keys or Abbreviated dialing numbers.

1



Set document(s) face down.

DOCUMENT SET

2

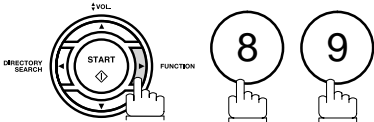

MEMORY XMT?

3

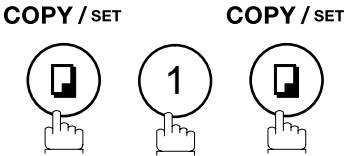

DOCUMENT SET

4

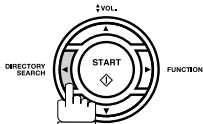

ENTER LETTER(S)

5

Enter the full station name or part of a station name by using the Keypad.

Ex: **S** **A** for searching **SALES DEPT**

SA

6

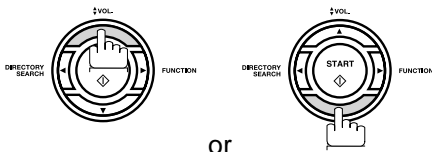

OR

repeatedly until the display shows the station name you want to send to.

[10] SALES DEPT

7

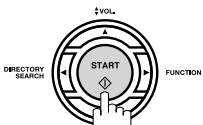

The full number will be dialed.

Sending Documents

Voice Mode Transmission

If you wish to send the document after talking with other party, use Voice Mode Transmission. Your machine requires an optional fax handset or an external telephone.

Off-Hook Dialing

For Off-Hook Dialing, follow the steps below.

1



Set document(s) face down.

DOCUMENT SET

2

Lift the fax handset or the external telephone and dial the telephone number from the Keypad.

Ex: (5) (5) (5) (1) (2) (3) (4)

PHONE OFF HOOK

3

When you hear the voice of the other party, tell the other party to prepare to receive a document.

Then, when you hear a beep,

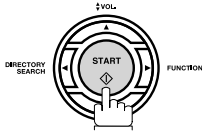

and hang up the handset or the external telephone.

NOTE

- To stop the transmission, press **STOP**.
The display shows:

COMM. STOP?

Press **SET** and **1** to stop the transmission.

Voice Mode Transmission

On-Hook Dialing

For On-Hook Dialing, follow the steps below.

1



Set document(s) face down.

DOCUMENT SET

2

MONITOR



You will hear dial tone through the monitor speaker.

ENTER TEL NO.

3

Dial the telephone number from the Keypad.

Ex: ⑤ ⑤ ⑤ ① ② ③ ④

5551234 ■

4

When you hear a beep,

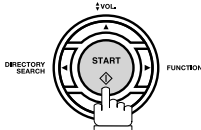

NOTE

1. If you need a special access number to get an outside line, dial it first then press **PAUSE** to enter a pause (represented by a "-") before dialing the full number.
Ex: 9 PAUSE 5551234
2. If you are using Pulse dialing and you wish to change to Tone dialing in the middle of dialing, press **TONE** (represented by a "/").
The dialing mode will be changed from Pulse to Tone after dialing the digit "/".
Ex: 9 PAUSE TONE 5551234

Sending Documents

Transmission Reservation

You can do the following while sending a document(s) from memory or receiving a document(s).

- Reserve the next transmission into memory. (Up to 5 different files)
- Reserve a priority transmission.

Memory Transmission Reservation (Multi-Tasking)

If your machine is on-line busy transmitting from memory, receiving or printing received documents, you can reserve a transmission by the following procedure.

1 Your machine is on-line.

ON LINE * XMT *

ON LINE * RCV *

* PC MODE *

* PRINTING *

2  Set document(s) face down.

DOCUMENT SET

3 Dial by any combination of the following methods:

- One-Touch Dialing
- Abbreviated Dialing
- Manual Number Dialing, press after each station is entered (up to 7 stations)
- Directory Search Dialing, press after each station is entered (For details, see pages 42 to 44.)

Ex:

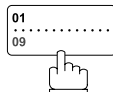

<01> Station name

ABBR / SPACE

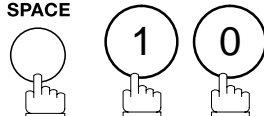

[10] Station name

If you want to confirm the number of stations you have entered, press .

002 STN(S) SET

4

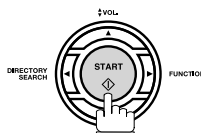

Your machine will store the document(s) into memory.

* STORE * 05%



Transmission Reservation

Direct Transmission Reservation (Priority Transmission Reservation)

If you are in a rush to send an urgent document, however there are many files in the memory, use Direct Transmission Reservation to send the urgent document. The urgent document will be sent immediately after the current communication is finished.

Note that you cannot send document(s) to multiple stations.

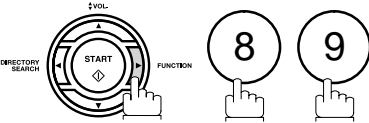
To reserve your machine for sending the urgent documents

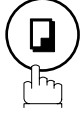
- | | | |
|---|--|-------------------|
| 1 | Your machine is on-line. | ON LINE * XMT * |
| | | ON LINE * RCV * |
| | | * PC MODE * |
| | | * PRINTING * |
| 2 |  Set document(s) face down. | DOCUMENT SET |
| 3 |  | MEMORY XMT? |
| 4 | <div style="display: flex; justify-content: space-around; align-items: center;"> <div style="text-align: center;"> <p>COPY / SET</p>  </div> <div style="text-align: center;"> <p>1</p>  </div> <div style="text-align: center;"> <p>COPY / SET</p>  </div> </div> | DOCUMENT SET |
| 5 | <p>Dial by using any one of the following methods:</p> <ul style="list-style-type: none"> • One-Touch Dialing • Abbreviated Dialing • Manual Number Dialing and press START • Directory Search Dialing and press START
(For details, see pages 46 to 49.) <p>Ex: 01</p> <p>You can make reservation to send an urgent document to a single station only.</p> | <01> Station name |

Sending Documents

Redialing

Automatic Redialing

If a busy line is detected, the machine will redial the number up to 5 times at 3 minutes interval. However, if a busy line is not detected, the machine will redial only one time. During that time, a message will appear as shown to the right.

WAITING TO DIAL

Manual Redialing

You can also redial the last dialed number manually by pressing **REDIAL** key.

To redial the last dialed number through memory

1



Set document(s) face down.

DOCUMENT SET

2



5551234

3

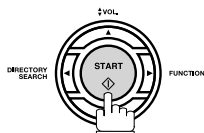

The document is stored into memory. Then the machine dials the last dialed number.

* STORE * 05%

Redialing

To redial the last dialed number through ADF

1



Set document(s) face down.

DOCUMENT SET

2

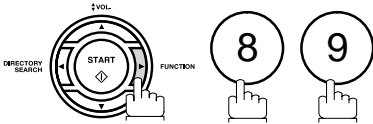

MEMORY XMT?

3

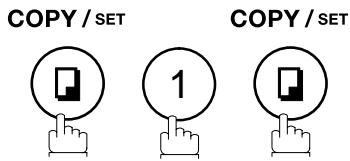

DOCUMENT SET

4

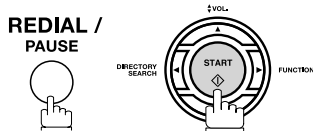

5551234

Your machine starts to dial the last dialed number.

NOTE

1. While the unit is displaying "WAITING TO DIAL", you can press **REDIAL** to start redialing immediately.

Receiving Documents

Reception Modes

You can select one of the four modes as shown below.

Conditions	Suggested Reception Mode	Settings
You normally receive only voice calls.	Telephone Mode (IN Mode) You can answer the incoming call via an External Telephone (Optional). If you receive a fax calling signal, simply press START to receive manually. (See page 57)	1. Fax Parameter No. 15 set to 1: Tel 2. Press the IN/OUT button to turn the lamp OFF. RCV MODE=TEL
You receive both voice and fax calls.	Fax / Tel Auto Switching Mode (IN Mode) Unit will answer the incoming call then distinguishes whether it is voice or fax call. If it is a fax call, the unit will receive automatically. If it is a voice call, the unit will signal (ring) through the speaker for your attention. (See page 58)	1. Fax Parameter No. 15 set to 2: Fax / Tel SW. 2. Press the IN/OUT button to turn the lamp OFF. RCV MODE=FAX/TEL
You normally receive fax calls only.	Fax Mode (OUT Mode) Unit will receive the document(s) automatically. All incoming calls (including a voice call) are answered by the fax machine. (See page 59)	1. Fax Parameter No. 16 set to 1: Fax 2. Press the IN/OUT button to turn the lamp ON. RCV MODE=FAX
You receive both voice and fax calls and a Telephone Answering Machine (TAM) is connected.	TAM Interface Mode (OUT Mode) The TAM answers the incoming call. During that time, the unit also monitors whether it is a voice call, the TAM continues to operate. If it is a fax call, the unit will automatically switch the line to the Fax and begin receiving the document(s). (See page 60)	1. Fax Parameter No. 16 set to 2: TAM / Fax 2. Press the IN/OUT button to turn the lamp ON. RCV MODE=TAM/FAX

NOTE

1. Depending on the model of the Telephone Answering Machine (TAM) that is connected, some of the features may not be compatible with your fax machine operating in the TAM Interface mode.
2. If you are using the "Distinctive Ring Service" provided by your local telephone company, please note that the ring pattern for your fax number must match with the setting of Fax Parameter No. 36 (RING PATTERN DETECT). (See page 34)
If the setting does not match with the ring pattern, your machine will not receive a document automatically and the telephone will continue to ring.
Furthermore, if your TAM does not support the "Distinctive Ring Detector" service, it may not function properly in TAM Interface.

Telephone Mode

When your machine is set to this mode, your machine will not receive documents automatically. If you receive a fax call, follow the procedure below to receive documents manually.

Setting the Telephone Mode

1 Change Fax Parameter No. 15 (IN MODE) to 1: Tel.
(See page 33)

2 **IN/OUT**



Make sure that the lamp goes off.

RCV MODE=TEL

Operation of Telephone Mode

1 When your telephone rings, lift the handset of the External Telephone.
If you hear a beep from the phone, it means someone wants to send a fax. Or, if the caller answers and says he/she wants to send a fax, then...

2 Remove any document from the ADF.

3a If you answered the call using the External Telephone,

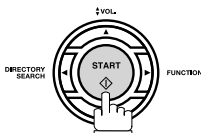

3b If you answered the call on an Extension phone,

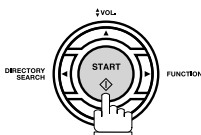

or

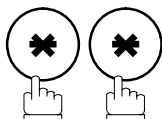

within 1 second on your Extension phone. (See Note 1)

Your machine will be activated remotely.

4 Hang up the phone.

NOTE

1. This procedure is called "REMOTE RCV" and will only work on a touch tone phone. If your extension phone is not a touch tone phone, press **START** on the control panel of your fax machine.

Receiving Documents

Fax / Tel Auto Switching Mode

When your machine is set to this mode, your machine will switch to document reception or voice communication automatically.

Setting the Fax / Tel Auto Switching Mode

1 Change Fax Parameter No. 15 (IN MODE) to 2: Fax / Tel SW.
(See page 33)

2 



Make sure that the lamp goes off.

RCV MODE=FAX/TEL

Operation of Fax / Tel Auto Switching Mode

If it is a Fax call,

1 Your machine will answer the call when a call is received, then distinguish whether it is a voice or fax call.

2 Your machine begins to receive the documents.

If it is a Voice call,

1 Your machine will answer the call when a call is received, then distinguish whether it is a voice or fax call.

2 Your machine begins to signal (ringing) through the machine's speaker for your attention. (See Note 1)

3 Lift the handset of the External Telephone and press **STOP**.

4 Begin the conversation.

NOTE

1. The length of time the machine signals can be changed by Fax Parameter No. 18 (OP CALL TIMER). (See page 33)
2. To adjust the Ringer Volume, refer to page 21.

Fax Mode

When your machine is set to this mode, it will immediately begin to receive documents automatically when a call is received.

Setting the Fax Mode

1 Change Fax Parameter No. 16 (OUT MODE) to 1: Fax.
(See page 33)

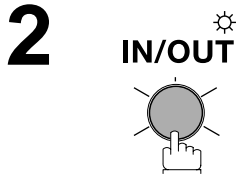

Make sure that the lamp goes on.

RCV MODE=FAX

Operation of Fax Mode

Your machine will begin receiving automatically when a fax call is received.

TAM (Telephone Answering Machine) Interface Mode

Your machine is equipped with a unique feature called TAM Interface which enables it to automatically switch a single telephone line either to Fax or TAM. You can connect most TAMs in the market to your machine and use your existing telephone line very efficiently. However, some TAMs may not be compatible with this machine. Answering Services (Voice Mail) provided by your Local Phone company are not compatible with this feature. For the operation of your TAM, please refer to the Operating Instructions of the TAM.

Installing your TAM

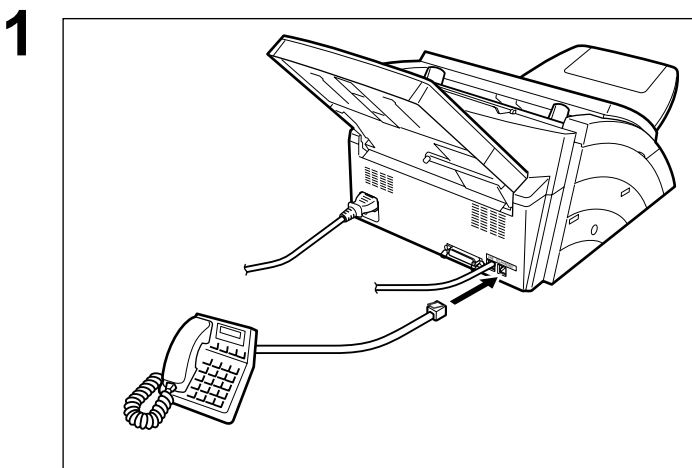

1. Remove the telephone line cable of your TAM from the wall jack.
2. Plug the telephone line cable of your TAM into the TEL jack on the rear of the fax machine as shown.

Receiving Documents

TAM (Telephone Answering Machine) Interface Mode

Setting the TAM Interface Mode

1 Change Fax Parameter No. 16 (OUT MODE) to 2: TAM / Fax
(See page 33)

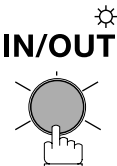
2  IN/OUT

RCV MODE=TAM/FAX

Make sure that the lamp goes on.

Operation of TAM Interface Mode

If it is a Fax call,

1 When your TAM and Fax receives an incoming call, the TAM always answers the call first and then the TAM plays the OGM (Outgoing Message) recorded in your TAM to the calling station. During the time the TAM is answering the call, your fax machine will be monitoring the line to distinguish whether it is a voice or fax call.

2 Your machine will switch the line to the fax and then begin to receive the documents immediately from the calling station.

If it is a Voice call,

1 When your TAM and Fax receives an incoming call, the TAM always answers the call first and then the TAM plays the OGM (Outgoing Message) recorded in your TAM to the calling station. During the time the TAM is answering the call, your fax machine will be monitoring the line to distinguish whether it is a voice or fax call.

2 Your TAM continues to record the incoming message (ICM) after playing the OGM.

Sample of OGM

Hello, this is Smith. Sorry I am unable to take your call. Please leave your message after the beep or if you are calling to send a fax, press the asterisk button twice on your touch tone phone now and start your machine. Thank you for calling.

Silent Detection Mode

Enables your Fax machine to switch to the Fax Mode when receiving from units that do not send fax signal (short beep) and prevents your TAM from recording blank (long silence) incoming message.

To activate this feature,

1. Change Fax Parameter No. 20 (SILENT DET.) to 2: Valid. (See page 33)
2. Set the time length of the OGM recorded in your TAM with the Fax Parameter No. 19 (OGM LENGTH). (See page 33)

[We recommend to set the time length 5 or 6 seconds longer than the actual time length of the OGM.]

Print Reduction

This machine can use Letter, Legal or A4 size plain paper for recording. Sometimes, oversized documents sent to you by the other parties cannot be printed within a single page. When this occurs, the document will be divided into separate pages.

This machine is equipped with a Print Reduction function to solve this problem. You may select the most appropriate setting from the selections described below.

1. Automatic Reduction

Each page of a received document is first stored in memory. Based on the document length, your machine will automatically calculate the suitable reduction ratio (70% to 100%) to print the entire document on a single page. If the received document is extremely long (over 39% longer than the recording paper), the document will be divided into separate pages and print without reduction.

2. Fixed Reduction

You can pre-determine the reduction ratio from 70% to 100% in 1% steps. The document(s) you receive will be reduced to the fixed ratio regardless of size.

Selecting the Print Reduction Mode

Set Fax Parameters as shown below.

1. To set Automatic Reduction mode.

a) No. 24 Print Reduction set to "Auto".

2. To set Fixed Reduction mode.

a) No. 24 Print Reduction set to "Fixed".

b) No. 25 Reduction Ratio set to any number between 70% through 100%. (See Note 1)

Ex: A4 to A4	96%
A4 to Letter	90%
Letter to Letter	96%
Legal to Letter	75%

NOTE

1. If the sending side is set to print the header on the outside of the copy area, more reduction ratio will be required.

Receiving Documents

Receiving Oversize Documents

If the received document is extremely long (over 39% longer than the recording paper), the document will be divided into separate pages. When printing on separate pages, the bottom 0.4 in (10 mm) of the first page will be overlapped on top of the next page.

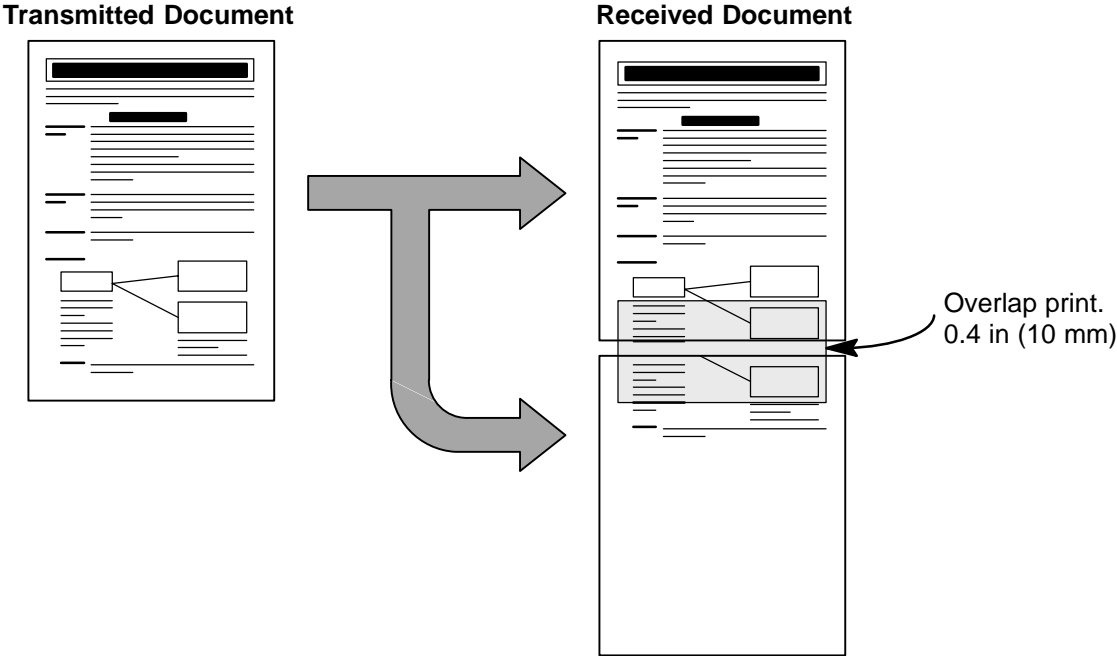

The receiving document is divided into two sheets with overlap printing.

NOTE

1. If the reduction method is set to the Automatic Reduction mode, the document is printed out with no reduction when printing out separate pages. If the reduction method is set to Fixed Reduction mode, the document is printed out by the ratio you set in Fax Parameter No. 25.

Substitute Memory Reception

If the recording paper runs out or jams or if the toner runs out during reception, the machine automatically starts receiving documents into its image data memory. Stored documents are printed automatically after replacing the recording paper or the toner cartridge. (See Notes 1 and 2)

- 1** When the machine finishes the memory reception and there is no recording paper or toner, an Information Code appears on the display.
- 2** Install the recording paper (see page 17) or replace the toner cartridge (see page 15). The machine will automatically start printing the document stored in the memory.

NO REC. PAPER 010

OUT OF TONER 041

* PRINTING *

Print Collation Mode

The printing mechanism of the UF-490 is a Reverse Order Stacking construction. The UF-490 has a Print Collation Mode that stacks received documents in the correct order. When the Print Collation Mode is enabled, all received documents are stored into memory first, then printed out in Correct Order Stacking. The requirements for the Print Collation Mode to be active are; 1) Fax Parameter No. 65 PRINT COLLATION set to "Valid", and 2) enough remaining memory.

The unit will print in Reverse Order Stacking (Non-Collation Mode) whenever one of the above requirements is not met.

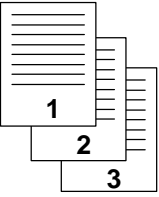
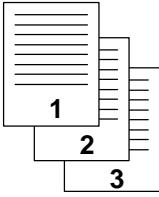
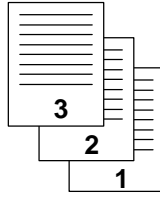
Sending Document Order	Stacking Document Order	
	<p>Correct Order Stacking (Collation Mode)</p> 	<p>Reverse Order Stacking (Non-Collation Mode)</p> 

NOTE

1. If the memory overflows, the machine will stop receiving and release the communication line. The document(s) stored in the memory up to that moment will be printed out.
2. If you wish to turn off the substitute reception function, change the setting of Fax Parameter No. 22 to "Invalid". (See page 34)

Making Copies

Your machine has a copy function which can make single or multiple copies.

1



Set document(s) face down.

DOCUMENT SET

2

COPY / SET



NO. OF COPY=1

3

Enter the number of copies.

Ex: (1) (0)

NO. OF COPY=10

4

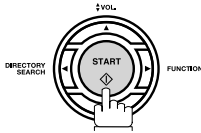

The machine stores the document, then prints the copies.

* STORE * 05%

NOTE

1. The copy will be reduced automatically depending on the length of the original document. If you wish to be prompted for the reduction ratio when making copies, change the setting of Fax Parameter No. 32 (COPY REDUCTION) to "Manual". (See page 33)
2. If you make a copy with Super Fine resolution, it will be reduced slightly even if the reduction ratio is set to 100% in order to fit the data on one page.
3. Standard Resolution is not available in Copy Mode.
4. If you experience a memory overflow error while making copies, you may turn "Off" the Memory XMT feature temporarily by pressing **FUNCTION** (8) (9) **SET** (1). However, the printed copies will not be collated.

Timer Controlled Communications

General Description

You can send document(s) to one or multiple stations at any preset time within the next 24 hours. Up to 5 built-in timers can be set for deferred communication.

Deferred Transmission

1



Set document(s) face down.

DOCUMENT SET

2

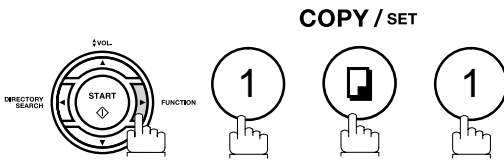

COPY / SET

START TIME ■ :

3

Enter the start time from the keypad and press **SET** .

(Use a 4-digit, 24-hour clock)
Ex: ② ③ ③ ① (11:30 p.m.) and **SET**

ENTER STN (S)

4

Dial by any combination of the following methods:

- One-Touch Dialing
- Abbreviated Dialing
- Manual Number Dialing, press **SET** after each station is entered (up to 7 stations)
- Directory Search Dialing, press **SET** after each station is entered (For details, see pages 42 to 44.)

Ex:

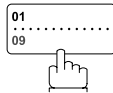

<01> Station name

ABBR / SPACE

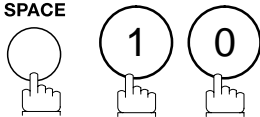

[10] Station name

If you want to confirm the number of stations you have entered, press **SET** .

002 STN(S) SET

5

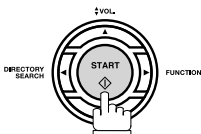

To store document(s) into the memory.

* STORE * 05%

NOTE

1. If you enter a wrong number in Step 4, press **CLEAR** then re-enter the right number.
2. To cancel the file in memory, press **FUNCTION** ① **SET** ② and use ▼ or ▲ to select the file that you want to cancel, then press **SET** **START** .

Polling

General Description

Polling means calling other station(s) to retrieve document(s). The other station must know in advance that you will call and must have document(s) set on the ADF or stored in the memory. You may need to set a polling password, shared by the other station, to ensure security.

Setting the Polling Password

If the polling password does not match with the polled station, your polling request will be refused automatically.

To set the polling password, follow the steps below.

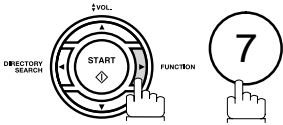
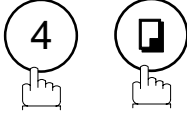
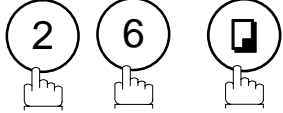
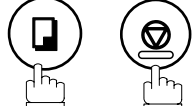
1		<input type="text" value="SET MODE (1-8)"/>
2	COPY / SET 	<input type="text" value="NO. = (01-99)"/>
3	COPY / SET 	<input type="text" value="POLLING PWD?"/>
4	Press <input type="text" value="SET"/> and enter a 4-digit polling password. Ex: ① ② ③ ④	<input type="text" value="1234"/>
5	COPY / SET STOP 	

NOTE

1. Polling might not function with all fax machines. We suggest you attempt a trial polling before you actually poll important document(s).
2. If a password is not set in the polled station, you may poll the other station even though your machine has a password.

To Poll Documents from Another Station

The following procedure lets you poll document(s) from one or multiple stations. Be sure to set the polling password before polling. (See page 66)

1

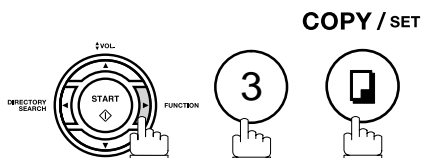

PASSWORD=1234

2

Enter a 4-digit polling password. (See Note 2)

Ex: (1) (1) (1) (1)

PASSWORD=1111

3

COPY / SET



ENTER STN(S)

4

Dial by any combination of the following methods:

- One-Touch Dialing
- Abbreviated Dialing
- Manual Number Dialing, press after each station is entered (up to 7 stations)
- Directory Search Dialing, press after each station is entered (For details, see pages 42 to 44.)

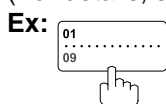

<01> Station name

ABBR / SPACE

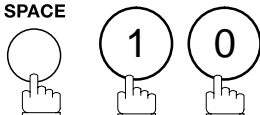

[10] Station name

If you want to confirm the number of stations you have entered, press .

002 STN(S) SET

5

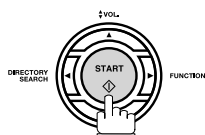

* STORE *

NOTE

1. You can review the entered stations in Step 4 by pressing or key, press to erase the displayed station or group as needed.
2. If you have set the polling password in Fax Parameter No. 26, the password will appear on the display.
You can still change the password temporarily by overwriting it with a new one.

Program Keys

General Description

Your fax machine has special Program Keys. These keys are useful if you frequently need to send or poll the same group of stations. You can use these keys to store a One-Touch group key, a sequence of stations to be polled, a deferred transmission sequence or an additional One-Touch key.

Setting for Group Dialing

To set a Program Key for Group Dialing

1

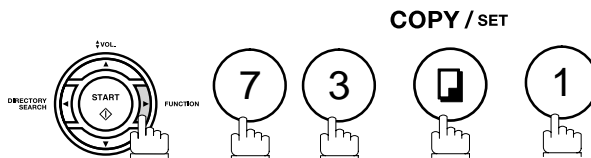

GROUP DIAL?

2



PRESS P-KEY

3

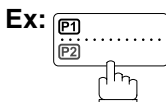

[P1] ENTER NAME

4

Enter the Group Name (up to 15 characters) by using the Keypad. (See page 26)

Ex: GROUP A and press **SET**

ENTER STN(S)

5

Enter the station numbers by using One-Touch Key or

ABBR and 2-digit code.

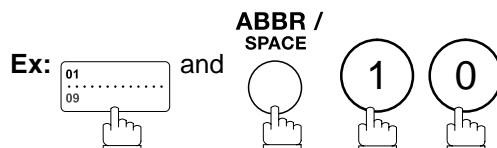

You may use the **▼** or **▲** keys to review the entered station(s) before going to next step. If you find an error, press **CLEAR** to erase the displayed station.

<01> Station name

[10] Station name

6

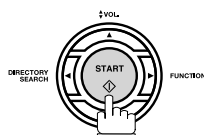

PRESS P-KEY

You can now set other Program Keys by repeating the procedures from Step 3, or return to standby by pressing

STOP.

Setting for Deferred Transmission

To set a Program Key for deferred transmission

1

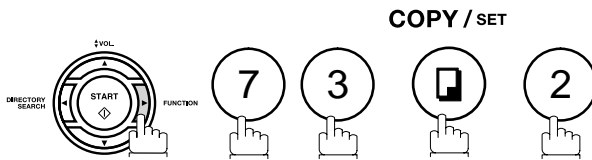

PROGRAM DIAL?

2

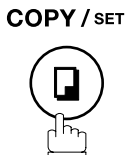

PRESS P-KEY

3

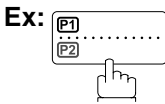

[P1] ENTER NAME

4

Enter the Key Name (up to 15 characters) by using the Keypad. (See page 26)

Ex: PROG. A and press **SET**

PRESS FUNCTION

5

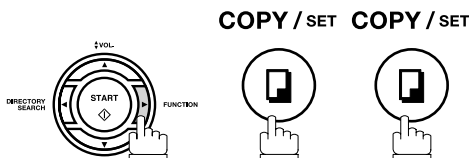

START TIME ■ :

6

Enter the starting time using 4 digits.

Ex: ② ③ ③ ① (11:30 p.m.) and press **SET**

ENTER STN(S)

7

Enter the station numbers by using One-Touch Key or **ABBR** and 2-digit code.

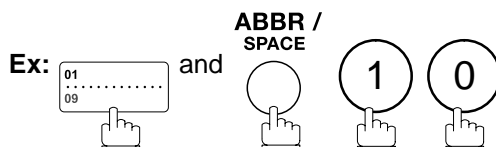

<01> Station name

[10] Station name

You may use the **▼** or **▲** keys to review the entered station(s) before going to next step. If you find an error, press **CLEAR** to erase the displayed station.

8

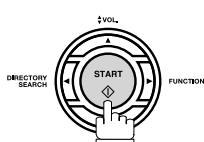

PRESS P-KEY

You can now set other Program Keys by repeating the procedures from Step 3, or return to standby by pressing

STOP.

Program Keys

Setting for Polling

To set a Program Key for polling

1

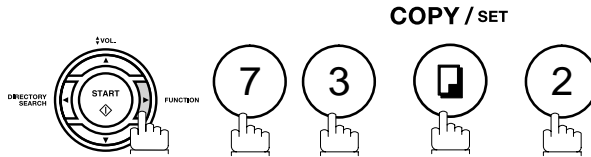

PROGRAM DIAL?

2



PRESS P-KEY

3

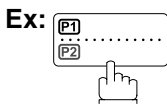

[P1] ENTER NAME

4

Enter the Key Name (up to 15 characters) by using the Keypad. (See page 26)

Ex: PROG. A and press

PRESS FUNCTION

5

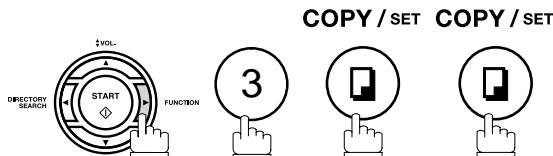

PASSWORD=1234

6

Enter a 4-digit polling password.

Ex: and press

ENTER STN(S)

7

Enter the station numbers by using One-Touch Key or and 2-digit code.

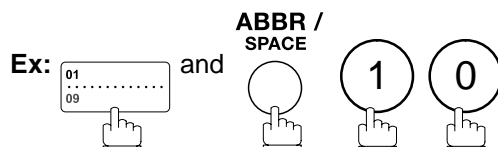

<01> Station name

[10] Station name

You may use the or keys to review the entered station(s) before going to next step. If you find an error, press to erase the displayed station.

8

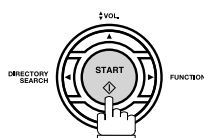

PRESS P-KEY

You can now set other Program Keys by repeating the procedures from Step 3, or return to standby by pressing

.

Setting for One-Touch Key

To set a Program Key for One-Touch Key

1

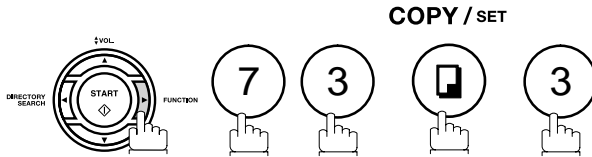

ONE-TOUCH DIAL?

2

COPY / SET



PRESS P-KEY

3

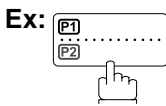

[P1] ENTER NAME

4

Enter the station name (up to 15 characters) by using the Keypad. (See page 26)

Ex: PROG. A and press SET

[P1] ENTER TEL.#

5

Enter a telephone number (up to 36 digits including pauses and spaces).

Ex: 9 PAUSE 5 5 5 SPACE 1 2 3 4

[P1] 9-555 1234

6

COPY / SET

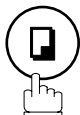

PRESS P-KEY

You can now set other Program Keys by repeating the procedures from Step 3, or return to standby by pressing

STOP.

Program Keys

Changing or Erasing the Program Key Settings

To change the settings in a Program Key, follow the procedure on setting a Program Key on pages 68 to 71.

- Start time or station(s) for deferred transmission
- Station(s) for polling
- Station(s) for group dialing
- Telephone number and station name for One-Touch key

To erase the settings in a Program Key

1

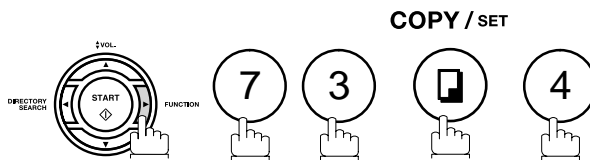

DELETE PROGRAM?

2



PRESS P-KEY

3

Press the Program Key you want to erase.

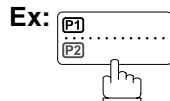

[P1] DELETE?

4

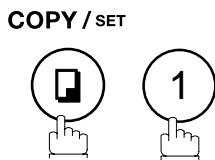

* DELETING *

5

You can now erase other Program Keys by repeating the procedures from Step 3, or return to standby by pressing



PRESS P-KEY

Access Code

General Description

The Access Code prevents an unauthorized user from operating the machine. Once a 4-digit Access Code is registered, no one can operate the machine without entering the correct access code.

Automatic Receiving, however, is always available. After you complete any operation, such as mode setting or transmission, and the display returns to standby, you have to re-enter the access code in order to use the machine again. Registering the Access Code does not affect the use of the machine in any other way.

Setting the Access Code

1

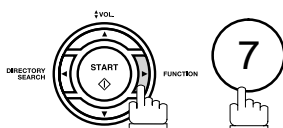

SET MODE (1-8)

2

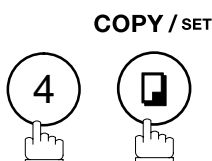

NO. = (01-99)

3

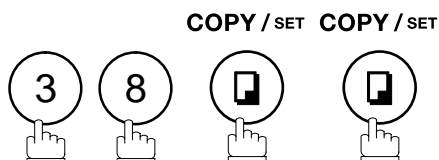

4

Enter a 4-digit Access Code.

Ex: ① ② ③ ④



5

COPY / SET



6

Select Restriction Level.

① for All operations

or

② for Setting and Printing the Fax Parameters only.

Ex: ②



7

COPY / SET STOP

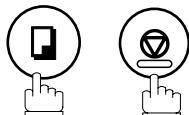

NOTE

1. To erase the Access Code, enter the Access Code and press **START** and follow the procedure above to Step 3, then press **CLEAR** **SET** and **STOP**.

Access Code

Operating Your Machine with the Access Code (Restrict All Operations)

1 Enter the Access Code.
Ex: ① ② ③ ④

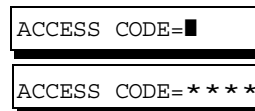

2 **COPY / SET**

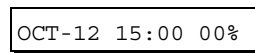

Now you can operate the machine normally.

Operating Your Machine with the Access Code (Restrict Access of Fax Parameters Only)

The machine can restrict the operation of setting and printing the Fax Parameters only.
Ex: When setting the Fax Parameter.

1



2 **COPY / SET**

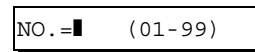

3 Enter a 4-digit Access Code.
Ex: ① ② ③ ④

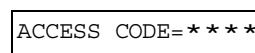

4 **COPY / SET**

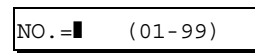

Now you can operate the machine normally.

Distinctive Ring Detector (DRD)

General Description

Your machine has a special feature in conjunction with an optional service provided by many local telephone companies. It can distinguish up to 4 telephone numbers with a corresponding ring pattern identifying each number. "DRD" lets you provide multiple phone numbers, one for your fax, business or personal use with only one single phone line.

Please check with your local telephone company on the availability of this service in your area.

Your machine can be programmed to respond to only 1 of the 4 distinctive ring patterns. To select the corresponding ring pattern for your fax number, refer to the Fax Parameter Table on page 34.

The following table shows a typical example with 4 telephone numbers on a single phone line

Telephone No.	Usage	Distinctive Ring Sound	Ring Pattern
555-1111	Business	Riiing.....Riiing.....	Type A, Standard Ring
555-2222	Fax	Ring..Ring.....Ring..Ring.....	Type B, Double Ring
555-3333	Personal	Ring..Ring...Riiing.....Ring..Ring...Riiing.....	Type C, Triple Ring (Short-Short-Long)
555-4444	Teenager	Ring...Riiing...Ring.....Ring...Riiing...Ring.....	Type D, Triple Ring (All other than type C)

The following illustration shows a typical set up, with your machine set to detect Type B (double ring) ring pattern.

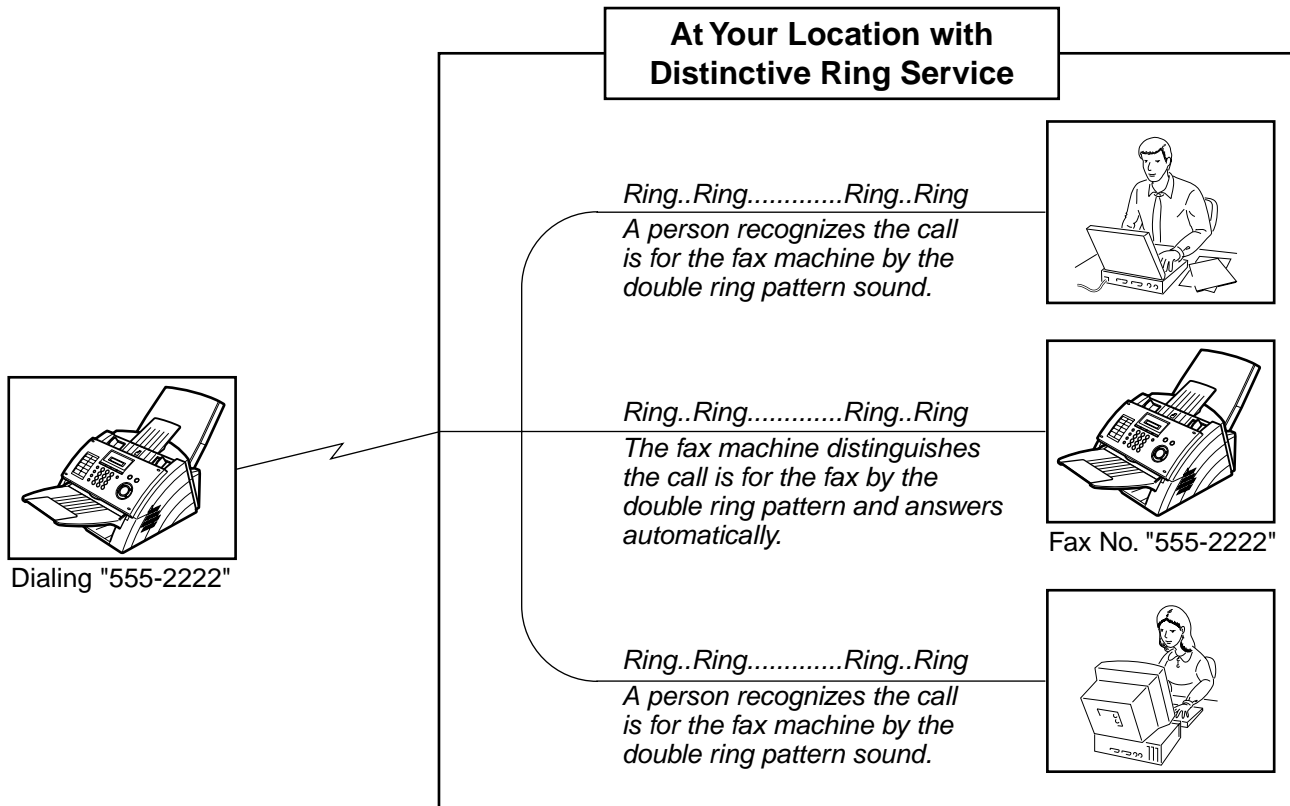

NOTE



1. "Riiing" means a long ringing sound and "Ring" means a short ringing sound.

PIN Code Access

General Description

If your PBX requires a PIN (Personal Identification Number) code to get an outside line, your machine can be set to prompt the user to enter a PIN code before any dialing.

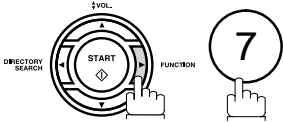
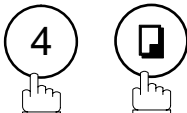
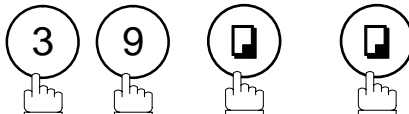
Selecting the Access Method (Prefix or Suffix)

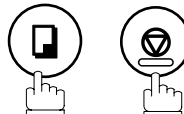
1		SET MODE (1-8)
2	<p>COPY / SET</p> 	NO. =■ (01-99)
3	<p>COPY / SET COPY / SET</p> 	NONE<>
4	 <p>for suffix code.</p> <p>or</p>  <p>for prefix code.</p>	SUFFIX<>
5	<p>COPY / SET STOP</p> 	PREFIX<>

Dialing with a PIN Code

1



Set document(s) face down.

DOCUMENT SET

2

Dial by any combination of the following methods:

- One-Touch Dialing
- Abbreviated Dialing
- Manual Number Dialing, press **SET** after each station is entered (up to 7 stations)
- Directory Search Dialing, press **SET** after each station is entered (For details, see pages 42 to 44.)

Ex:

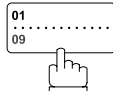

ABBR /
SPACE

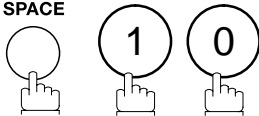

If you want to confirm the number of stations you have entered, press **SET**.

<01> Station name

[10] Station name

002 STN(S) SET

3

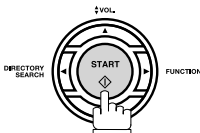

ENTER PIN CODE

4

Ex: 9 8 7 6 (up to 36 digits)

9876

5

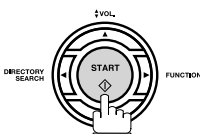

* STORE * 05%

Your machine stores the document and starts dialing the PIN code and telephone number as you specified.



NOTE

1. The PIN code is shown as " ■ " on the display when dialing the number.
2. This feature is not available when dialing a number by using Off-Hook or On-Hook Direct Dialing mode.

Fax Forward

Setting Fax Forward

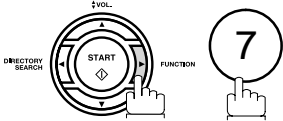
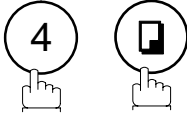
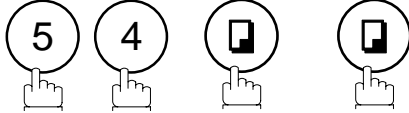
This feature allows all incoming faxes to be forwarded to the station registered in the one-touch or abbreviated dialing number. Once the faxes are received in the memory, the machine will forward the received document(s) to the telephone number registered in the one-touch or abbreviated dialing number. This function is convenient when you would like to receive faxes in another place (i. e. your home) at night or during a holiday.

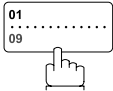
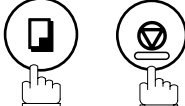
1		SET MODE (1-8)
2	<p style="margin: 0;">COPY / SET</p> 	NO. = (01-99)
3	<p style="margin: 0;">COPY / SET COPY / SET</p> 	INVALID<>
4		VALID<>
5	<p style="margin: 0;">COPY / SET</p> 	ENTER STATION
6	<p>Enter the station to forward the received faxes to, by assigning a One-Touch key or an Abbreviated dialing number.</p> <p>Ex:</p> 	<01> Station name
7	<p style="margin: 0;">COPY / SET STOP</p> 	

NOTE

1. When the Fax Forward feature is set, the One-Touch or the Abbreviated dialing number is restricted from editing. Please change this function to "Invalid" when you would like to edit the telephone number.
2. It is not possible to receive a document if the memory of your machine overflows or is about 95% used.

Sub-Addressing

General Description

The Sub-Addressing function allows you further routing, forwarding or relaying of document(s) to the desired recipient(s) when used in combination with Panasonic Internet Fax capable models and/or the Networking version of HydraFax/LaserFAX software. This function conforms to the ITU-T recommendation for T. Routing-Facsimile Routing utilizing the Sub-Address.

Example of a Network

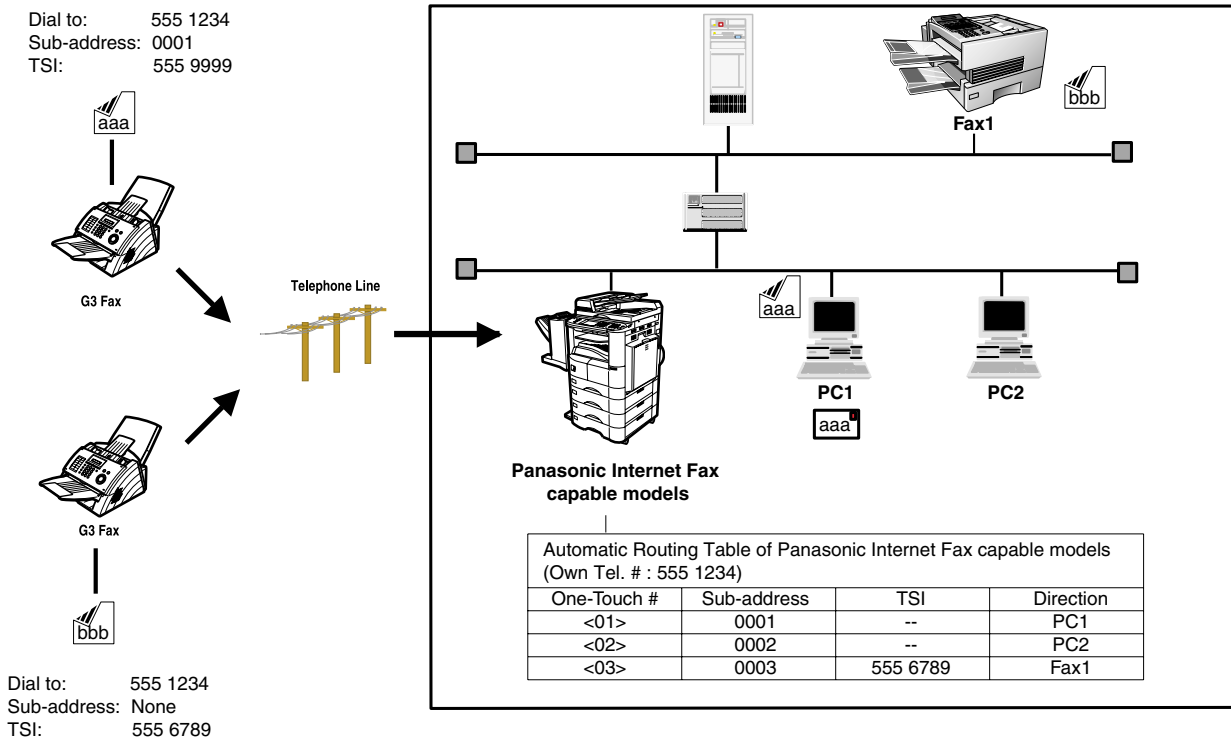

Compatibility with Other Machines

- Sub-Addressing Transmission: DF-1100/DP-135FP/150FP/150FX/DP-2000/2500/3000/DX-1000/2000/FP-D250F/D350F/UF-332/333/342/344/490/550/560/585/595/770/788/880/885/895 (see Note 2)
- Sub-Addressing Reception: DX-1000/2000/DP-2000/2500/3000 with I-FAX Option and DF-1100/UF-342/344/550/560/585/595/770/788/880 with PC Interface using the Networking version of HydraFax/LaserFAX software.

Sub-Addressing Transmission Methods

You can send a document with Sub-Address information to the desired recipient by the following methods.

- By registering the Sub-Address information into One-Touch/ABBR. Dialing Numbers.
- By specifying the Sub-Address information in the Manual Number Dialing Mode.

Setting of Routing, Forwarding or Relaying

You can customize the Automatic Routing to any combination of LAN (Local Area Network), PSTN (Public Switched Telephone Network) or PBX Extension with Panasonic Internet Fax capable models and/or HydraFax/LaserFAX Routing Table (Please refer to the operating instructions of the applicable Panasonic models and/or the HydraFax/LaserFAX User Manual).

NOTE

1. HydraFax and LaserFAX are trademarks of Wordcraft International Ltd.
2. UF-788 with PC Interface Option or the Option ROM installed.

Sub-Addressing

Setting the Sub-Address into a One-Touch/ABBR. Dialing Numbers

1

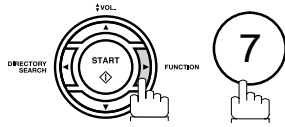

SET MODE (1-8)

2

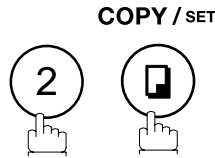

1:ONE-TCH 2:ABBR

3

Press ① to select "One-Touch"
or
Press ② to select "ABBR. NO."

Ex: ①

PRESS ONE-TOUCH

4

Press a One-Touch key (01 - 16).

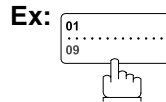

<01>ENTER TEL.#

5

Enter the telephone number, press **FLASH** then enter the Sub-Address (up to 20 digits).
(Up to 36 digits including telephone number, pauses, spaces, FLASH and Sub-Address)

Ex: Telephone number = 5551234, Sub-Address =2762

Enter as: ⑤ ⑤ ⑤ ① ② ③ ④ **FLASH** ② ⑦ ⑥ ②

<01>551234s2762

6

COPY / SET



And then continue to enter the station name.
(See page 27)

<01>SALES DEPT

7

COPY / SET STOP

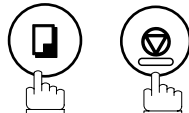

NOTE

1. **FLASH** separates the Sub-Address from the Telephone number and is indicated by an "s" in the display.

Sending a Fax with Sub-Address

Use **FLASH** to separate the Telephone number and the Sub-Address.

1



Set document(s) face down.

DOCUMENT SET

2

Enter the telephone number, press **FLASH** then enter the Sub-Address (up to 20 digits).
(Up to 36 digits including telephone number, pauses, spaces, FLASH and Sub-Address)

Ex: Telephone number = 5551234, Sub-Address =2762

Enter as: (5) (5) (5) (1) (2) (3) (4) **FLASH** (2) (7) (6) (2)

5551234s2762

3

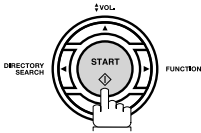

The document is stored into memory and your machine starts to dial the number of the station and sends the document(s) with Sub-Addressing information.

* STORE * 05%

NOTE

1. **FLASH** separates the Sub-Address from the Telephone number and is indicated by an "s" in the display.
2. Manual Off-Hook or On-Hook Dialing cannot be used with the Sub-Addressing Transmission.
3. The Sub-Address is not transmitted during Manual Redial Mode.

Journals and Lists

General Description

To help you maintain records of the documents you sent and received, as well as lists of the numbers you record, your facsimile machine is equipped to print the following journals and lists: Transaction Journal, Individual Transmission Journal, Communication Journal, One-Touch/Abbreviated/Directory Search No. List, Program List, Fax Parameter List and Directory Sheet.

Transaction Journal

The "Journal" is a record of the last 32 transactions (a transaction is recorded each time you send or receive a document). It prints automatically after every 32 transactions (see Note 1) or you can print or view it manually by using the following procedure:

1

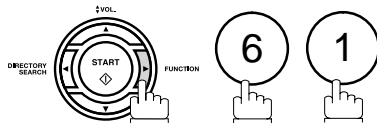

JOURNAL?

2

COPY / SET



1:PRINT 2:VIEW

3a

① To print a Journal

* PRINTING *

3b

② To view a Journal

1:XMT ONLY 2:ALL

4

Select the viewing mode.

① To view transmission transactions only

② To view all transactions

Ex: ②

You can view the transactions in the journal by pressing

▼ or ▲. Press **STOP** to return to standby.

Use ◀ or ▶ to switch the display.

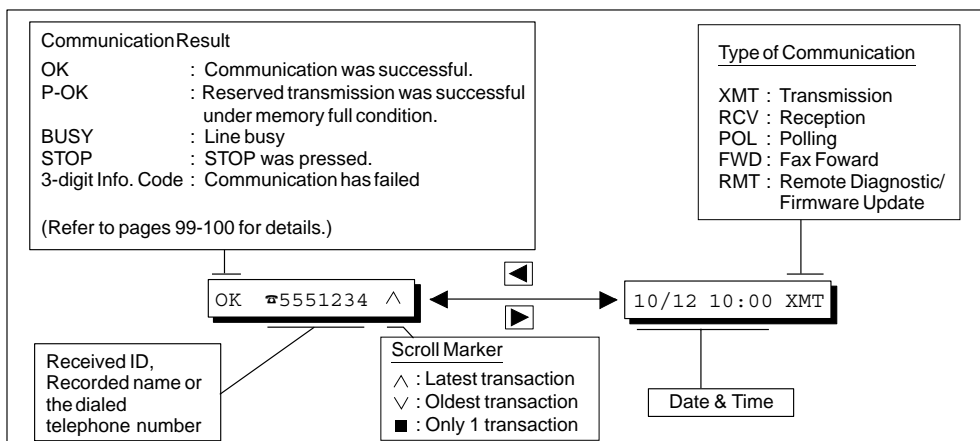

NOTE

1. If you wish to disable the automatic printing of the Transaction Journal, change the setting of Fax Parameter No. 13 to "Invalid". (See page 33)

Individual Transmission Journal (IND. XMT JOURNAL)

An Individual Transmission Journal contains the information on the latest transmission.

1

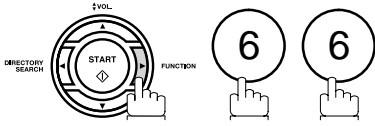

IND. JOURNAL?

2

COPY / SET



* PRINTING *

Journals and Lists

Individual Transmission Journal (IND. XMT JOURNAL)

Sample Transaction Journal

***** -JOURNAL- *****									
(1)							(2)		
DATE OCT-12-2001 ***** TIME 15:00 *****									
(3)	(4)	(5)	(6)	(7)	(8)	(9)	(10)	(11)	(12)
NO.	COMM.	PAGES	FILE	DURATION	X/R	IDENTIFICATION	DATE	TIME	DIAGNOSTIC
01	OK	005/005	001	00:00:22	XMT	SERVICE DEPT.	OCT-11	17:35	C0044903C0000
02	OK	003	002	00:01:17	RCV	111 222 333	OCT-11	17:41	C0044903C0000
03	OK	001	003	00:00:31	XMT	ACCOUNTING DEPT.	OCT-11	17:50	C0044903C0000
04	630	000/005	004	00:00:00	XMT	☎ 342345676	OCT-11	17:57	0800420000000
05	STOP	000	005	00:00:34	XMT	☎ 12324567	OCT-11	18:35	0210260200000
06	OK	001/001	006	00:00:20	XMT	☎ 44567345	OCT-11	18:44	C8044B03C0000
07	408	*003	007	00:02:14	XMT	☎ 2345678	OCT-11	18:55	0040440A30080
}									
31	OK	002/002	050	00:00:31	XMT	☎ 0245674533	OCT-12	08:35	C8044B03C1000
32	OK	003/003	051	00:01:32	XMT	☎ 0353678980	OCT-12	08:57	C8044B03C1000
***** -HEAD OFFICE - *****									
(13)							(14)		
-PANASONIC -									
201 555 1212- *****									
(15)							(14)		

Sample Individual Transmission Journal (IND. XMT JOURNAL)

***** -IND. XMT JOURNAL- *****									
(1)							(2)		
DATE OCT-12-2001 ***** TIME 15:00 *****									
(10)	(11)	DATE/TIME = OCT-12-2001 09:00							
(3)	JOURNAL No. = 21								
(4)	COMM. RESULT = OK								
(5)	PAGE(S) = 001/001								
(7)	DURATION = 00:00:16								
(6)	FILE No. = 010								
(16)	MODE = TRANSMISSION								
(17)	DESTINATION = [01] / 555 1234 /ABCDEFG								
(18)	RECEIVED ID =								
(19)	RESOLUTION = STD								
***** -HEAD OFFICE - *****									
(13)							(14)		
-PANASONIC -									
201 555 1212- *****									
(15)							(14)		

Individual Transmission Journal (IND. XMT JOURNAL)

Explanation of Contents

- (1) Printout date
- (2) Printout time
- (3) Journal number
- (4) Communication result : "OK" indicates that the communication was successful.
 "BUSY" indicates that the communication has failed because of busy line.
 "STOP" indicates that **STOP** was pressed during communication.
 "M-OK" indicates that the substitute reception message in memory was not printed.
 "P-OK" indicates that memory overflow or document misfeeding occurred while storing the documents into memory for transmission but successfully stored document(s) was sent.
 "3-digit Info Code" (see page 99) indicates that the communication has failed.
- (5) Number of pages transmitted or received : The 3-digit number is the number of pages successfully transmitted or received.
 When the documents are stored into memory, two 3-digit numbers will appear.
 The first 3-digit number represents the number of pages successfully transmitted. The second 3-digit number represents the total number of pages that were attempted to be transmitted.
 Asterisk "*" indicates that the quality of some received copies was poor.
- (6) File number : 001 to 999 (If the communication is stored into memory, a file number is assigned for each communication.)
- (7) Duration of communication
- (8) Type of communication : "XMT" means Transmission
 "RCV" means Reception
 "POL" means Polling
 "FWD" means Fax Forward
 "RMT" means Remote Diagnostic/Firmware Update
- (9) Remote station identification : Name : Recorded name in One-Touch or ABBR. Numbers or remote station's Character ID.
 ☎ number : Dialed telephone number (PIN Code will not be shown)
 Number : Remote station's ID number.
- (10) Communication date
- (11) Communication start time
- (12) Diagnostic : For service personnel only
- (13) Own LOGO : Up to 25 characters
- (14) Own ID number : Up to 20 digits
- (15) Own Character ID : Up to 16 characters
- (16) Type of communication : Transmission or memory transmission
- (17) Destination : If a One-Touch or ABBR was used for the transmission:
 One-Touch or ABBR. No./Telephone Number/Recorded Name
 If not : Telephone number
- (18) Received remote station's ID : Character ID or ID number
- (19) Resolution : "STD" means Standard resolution
 "FINE" means Fine resolution
 "S-FINE" means Super Fine resolution

Journals and Lists

Communication Journal (COMM. JOURNAL)

The Communication Journal (COMM. JOURNAL) lets you verify whether the transmission or polling was successful. You may select the printout condition (Off/Always/Inc. Only) in Function 8-1 or Fax Parameter No. 12.

Sample COMM. JOURNAL

***** -COMM. JOURNAL- ***** DATE OCT-12-2001 **** TIME 15:00 *****

(1) MODE = MEMORY TRANSMISSION (2) START=OCT-12 14:50 (3) END=OCT-12 15:00

FILE NO.= 050 (4)

(5) STN NO.	(6) COMM.	(7) ABBR NO.	(8) STATION NAME/TEL NO.	(9) PAGES	(10) DURATION
001	OK	<01>	SERVICE DEPT.	001/001	00:01:30
002	OK	<02>	SALES DEPT.	001/001	00:01:25
003	407	<03>	ACCOUNTING DEPT.	000/001	00:01:45
004	BUSY	☎	021 111 1234	000/001	00:00:00

- PANASONIC -

***** - HEAD OFFICE - ***** - 201 555 1212 - *****

THE SLEREXE COMPANY LIMITED

SAPORS LANE . BOOLE . DORSET . BH 25 8 ER

TELEPHONE BOOLE (945 13) 51617 - TELEX 123456

Our Ref. 350/PJC/EAC

18th January, 1972.

Dr. P.N. Cundall,
Mining Surveys Ltd

... variations of print density ...
cause the photocell to generate an analogous electrical video signal.
This signal is used to modulate a carrier, which is transmitted to a
remote destination over a radio or cable communications link.

At the remote terminal, demodulation reconstructs the video
signal, which is used to modulate the density of print produced by a
printing device. This device is scanning in a raster scan synchronised
with that at the transmitting terminal. As a result, a facsimile
copy of the subject document is produced.

Probably you have uses for this facility in your organisation.

Yours sincerely,

Phil.

P.J. CROSS
Group Leader - Facsimile Research

Communication Journal (COMM. JOURNAL)

Explanation of Contents

- (1) Indication of communication mode
- (2) Start time of communication
- (3) End time of communication
- (4) File number : 001 to 999 (When the communication is stored into memory, a file number is assigned for each communication.)
- (5) Station number : Sequential number of the Stations.
- (6) Communication result : "OK" indicates that the communication was successful.
 "BUSY" indicates that the communication has failed because of busy line.
 "STOP" indicates that **STOP** was pressed during communication.
 "M-OK" indicates that the substitute reception message in memory was not printed.
 "P-OK" indicates that memory overflow or document misfeeding occurred while storing the documents into memory for transmission but successfully stored document(s) was sent.
 "3-digit Info Code" (see page 99) Information Codes indicates that the communication has failed. In this case, the machine will print out the attached report with first page of your document as shown on the previous page.
- (7) Abbreviated number or ☎ mark : ☎ mark indicates dialed by direct number dial.
- (8) Recorded name in One-Touch, ABBR. or direct dialing number
- (9) Number of pages transmitted or received : The 3-digit number is the number of pages successfully transmitted or received.
 When the documents are stored into memory, two 3-digit numbers will appear.
 The first 3-digit number represents the number of pages successfully transmitted.
 The second 3-digit number represents the total number of pages that were attempted to be transmitted.
- (10) Duration of communication

Journals and Lists

One-Touch/Abbreviated and Directory Search List

To print a One-Touch/Abbreviated Number and Directory Search List of the telephone numbers you have stored

1

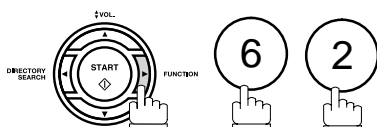

SPEED DIAL LIST?

2

COPY / SET

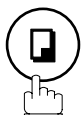

1:ONE/ABBR 2:DIR

3

To print a One-Touch/ABBR. Number List

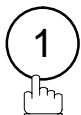

To print a Directory Search List



* PRINTING *

One-Touch/Abbreviated and Directory Search List

Sample One-Touch List

```

***** -ONE-TOUCH LIST- ***** DATE OCT-12-2001 ***** TIME 15:00 *****

      (1)      (2)      (3)
ONE-TOUCH  STATION NAME  TELEPHONE NO.

<01>      SERVICE DEPT.  121 555 1234
<02>      SALES DEPT.    222 666 2345
<03>      ACCOUNTING DEPT 313 333 3456

NO. OF STATIONS = 03 (4)

                                     -PANASONIC -

***** -HEAD OFFICE - ***** 201 555 1212- *****
    
```

Sample ABBR. Number List

```

***** -ABBR NO. LIST- ***** DATE OCT-12-2001 ***** TIME 15:00 *****

      (1)      (2)      (3)
ABBR NO.  STATION NAME  TELEPHONE NO.

[01]      ENG. DEPT.    888 555 1234
[02]      PURCHASE DEPT. 999 666 2345
[03]      REGULATION DEPT 777 333 3456

NO. OF STATIONS = 03 (4)

                                     -PANASONIC -

***** -HEAD OFFICE - ***** 201 555 1212- *****
    
```

Journals and Lists

One-Touch/Abbreviated and Directory Search List

Sample Directory Search List

```
***** -DIR. SEARCH LIST- ***** DATE OCT-12-2001 ***** TIME 15:00 *****

(5)  (2)          (1)          (3)
      STATION NAME  ABBR NO.  TELEPHONE NO.
[A]  ACCOUNTING DEPT <03>      313 333 3456

[E]  ENG. DEPT.      [01]      888 555 1234

[P]  PURCHASE DEPT  [02]      555 666 2345

[R]  REGULATION DEPT [03]      777 333 3456

[S]  SALES DEPT.    <01>      121 555 1234
      SERVICE DEPT  <02>      222 666 2345T

      NO. OF STATIONS = 06      (4)

                                           - PANASONIC -

***** -HEAD OFFICE - ***** 201 555 1212 - *****
```

Explanation of Contents

- (1) One-Touch number or Abbreviated number : <nn>= One-Touch number, [nn] = Abbreviated number
- (2) Station name recorded in the machine : Up to 15 characters
- (3) Telephone number recorded in the machine : Up to 36 digits
- (4) Number of recorded One-Touch and ABBR. numbers
- (5) The first letter of station name recorded in your machine

Program List

To print a Program List of the Dialing Patterns that you have previously entered into the Program Keys

1

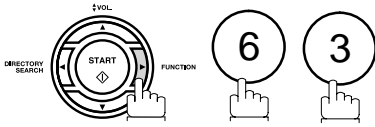

PROGRAM LIST?

2

COPY / SET



* PRINTING *

Sample Program List

```
***** -PROGRAM LIST- ***** DATE OCT-12-2001 ***** TIME 15:00 *****
(1)      (2)      (3)      (4)      (5)
PROGRAM  PROGRAM NAME      TYPE      TIMER      ABBR NOS.
[P1]     TIMER XMT          XMT        12:00      [01]
[P2]     TIMER POLL        POLL        19:00      [02]
                                                - PANASONIC -
***** -HEAD OFFICE - ***** 201 555 1212- *****
```

Explanation of Contents

- (1) Program key
- (2) Program name : Up to 15 characters
- (3) Type of communication : "XMT" indicates transmission.
"POLL" indicates polling.
"ABBR/GRP" indicates that the Program key is programmed as a group key.
"ONE-TOUCH" indicates that the Program key is programmed as a One-Touch key.
- (4) Timer : Indicates the starting time.
"----" indicates that the Program key contains "non-deferred" program.
- (5) Numbers recorded in the program : One-Touch/ABBR. numbers

Journals and Lists

FAX Parameter List

To print a Fax Parameter List

1

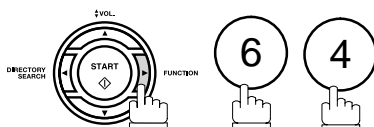

FAX PARAM. LIST?

2

COPY / SET

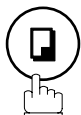

* PRINTING *

Sample FAX Parameter List

```
***** -FAX PARAMETER LIST- ***** DATE OCT-12-2001 ***** TIME 15:00 *****
```

(1) PARAMETER NUMBER	(2) DESCRIPTION	(3) SELECTION	(4) CURRENT SETTING	(5) STANDARD SETTING
(7) 01	CONTRAST (HOME)	(1:Normal 2:Lighter 3:Darker)	1	1
* 02	RESOLUTION (HOME)	(1:Standard 2:Fine 3:S-Fine 4:Halftone)	2	1
99	MEMORY SIZE		(1MB) (6)	
-PANASONIC-				
***** -HEAD OFFICE - ***** 201 555 1212- *****				

Explanation of Contents

- (1) Parameter number
- (2) Description : "(HOME)" means home position setting.
- (3) Selection
- (4) Current setting : "----" indicates code or password is not set. When the code or password is set, it is shown in parenthesis.
- (5) Standard setting : Factory preset standard setting
- (6) Memory size
- (7) Changed setting : "*" indicates that the Factory preset setting was changed.

Toner Cartridge and Drum Unit Supply Order Forms

To print the Supply Order Forms

1

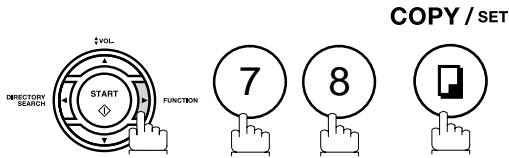

MAINTENANCE (1-9)

2

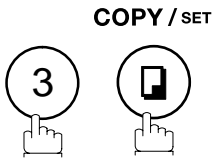

1: TONER 2: DRUM

3

To print a Toner Cartridge Order Form

* PRINTING *

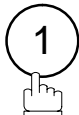

To print a Drum Unit Order Form



Sample Supply Order Forms

```

*****
> DRUM UNIT ORDER FORM <
*****

**** It is time to replace the drum Unit ****
To order a replacement Drum Unit from your Authorized Dealer
    
```

```

*****
> TONER CARTRIDGE ORDER FORM <
*****

**** The toner supply in your machine is running low ****
To order a replacement Cartridge from your Authorized Dealer

                                     )

                                     / /

_____/_____
Print your name and title

_____/_____
Signature & Date
    
```

Journals and Lists

Power Failure Report

If a power failure occurs, the document information stored in machine's memory will be lost. In this case, a Power Failure Report will be printed automatically after the power is re-stored. This report is not printed if no file(s) are stored in memory. Please print the Transaction Journal to confirm the file(s) that have been sent.

Sample Power Failure Report

```
***** -POWER FAILURE REPORT- ***** DATE OCT-12-2001 ***** TIME 15:00 *****

POWER FAILURE OCCURRED !

FROM *** OCT-12-2001 14:50 *** (1)

TO *** OCT-12-2001 15:00 *** (2)

FOLLOWING FILE(S) HAS BEEN LOST.
PLEASE CHECK THE JOURNAL

(3)  (4)          (5)          (6)          (7)  (8)
FILE  COMM. TYPE   CREATED TIME  START TIME  PAGES DESTINATION(S)
No.
001   MEM. DEF. XMT  OCT-12 12:00  23:00      001   <03>

                                     -PANASONIC                -

***** -HEAD OFFICE - ***** 201 555 1212- *****
```

Explanation of Contents

- (1) Power failure date and time
- (2) Power return date and time
- (3) File number
- (4) Communication type
- (5) Stored date/time : Date/time that these files were stored.
- (6) Executing time : If the file is a Timer Controlled Communication, the start time is printed in this column.
- (7) Number of stored page(s)
- (8) Destination : One-Touch No./ABBR. No./Manual Dialing No.

Troubleshooting

If You Have Any of These Problems

Mode	Symptom	Cause / Action	page
During Standby	The display is blinking	The battery is completely discharged. This may happen at first installation. After setting the clock, the blinking will stop.	--
During Transmission	Document doesn't feed/multiple feeds	<ol style="list-style-type: none"> 1. Check that your document is free of staples and paper clips, and that it is not greasy or torn. 2. Check that your document is the right type to send through an ADF by consulting the list on "Documents You Cannot Send". If your document has the characteristics listed, make a photocopy of your document and send the copy instead. 3. Check that the document is loaded properly. 4. Adjust the ADF Pressure. 	36 37 105
	Document jam	The information code 031 will appear on the display if the document becomes jammed.	102
Transmission Copy Quality	Vertical lines on the transmitted document	Check own copy quality. If copy is OK, your machine has no problem, report to the receiving party that they have a problem. If copy is NG, clean the Scanning Area.	103
	Transmitted document is blank	<ol style="list-style-type: none"> 1. Make sure the document is set face down. 2. Check own copy quality. If copy is OK, your machine has no problem, report to the receiving party that they have a problem. If copy is NG, clean the Scanning Area. 	103
During Reception	No recording paper	The information code 010 will appear on the display if the paper runs out.	17
	Recording paper jam	The information code 001 or 007 will appear on the display if the paper gets jammed.	101
	Recording paper doesn't advance into machine	Make sure that there is paper in the Paper Tray. Follow the instructions for loading paper.	17
	Recording paper doesn't eject after printing	Check to see if the recording paper is jammed inside of the machine.	101
	Document auto reduction doesn't work	Check Print Reduction settings.	61
	Out of toner	The information code 041 will appear on the display if the Toner Cartridge runs out of toner.	15
Print Copy Quality	Vertical lines printing on the received document	Print out a Journal report (e.g. FUNCTION, 6, 1, SET and 1) and check quality to make sure whether your machine has trouble. <ul style="list-style-type: none"> • If Journal report quality is OK, your machine has no problem, report to the sending party that they have a problem. • If copy is NG, replace the Drum Unit. 	82 15
	Fuzzy print	<ol style="list-style-type: none"> 1. Make sure you are using the correct paper for the best possible print quality. 2. Try reversing the recording paper to the other side. 	109
	Missing dots or lines/ inconsistent darkness within print	<ol style="list-style-type: none"> 1. Make sure you are using the correct paper for the best possible print quality. 2. Replace the Drum Unit. 	109 15
	Fading print	Your Toner Cartridge may be running out of toner. Replace the Toner Cartridge.	15
	Faint print	You may need to choose a different paper for the best possible print quality.	109

Troubleshooting

Mode	Symptom	Cause / Action	page
Communication	No dial tone	1. Check the connection of the telephone line. 2. Check the telephone line.	106
	No auto answer	1. Check the connection of the telephone line. 2. Check the Reception mode setting. 3. If the Fax Parameter No. 13 (AUTO JOURNAL PRINT) is set to "Valid" (default setting) and the machine is printing the received document(s) from memory, which also happens to be the 32nd transaction, the machine will not auto answer until the Transaction Journal completes printing.	106 56
	Cannot transmit or receive	An information code will be shown on the display. Refer to the information code table to find out the trouble.	99
No Unit Operation	No unit operation	To reset the machine, unplug the Power Cord for a few seconds then plug it in again.	18

Mode	Symptom	Cause / Action	page
TAM Interface Trouble in Unattended TAM I/F Mode (OUT Mode)	Cannot utilize the remote turn-on feature of the telephone answering machine (TAM). The fax machine always answers after the 8th ring.	This feature is not compatible. The fax machine is designed to answer after 8 rings if the TAM does not answer.	--
	Fax machine will not start up when the telephone answering machine is set to give only an outgoing message (OGM).	TAM that gives outgoing announcement only is not compatible. The fax machine will work with a TAM that will record incoming message (ICM).	--
	A beep...beep sound is recorded on the telephone answering machine.	Speak a little slower between each word while recording an outgoing message (OGM).	--
	Fax machine starts up in the middle of the outgoing message even though the caller wants to leave a voice message.	Make sure the outgoing message (OGM) does not have a silent pause longer than 5 seconds.	--
	Cannot record any incoming message (ICM). The fax machine always starts up at the end of the OGM and before the tape advances to the end of last ICM. (Your TAM only uses a single cassette tape to give OGM and record ICM.)	Set Fax Parameter No. 20 (Silent Detection) to "Invalid".And, instruct the calling party to press * twice on their touch-tone phone during the OGM to start up your fax machine remotely.	33
	Cannot receive from a machine that does not send CNG signal (a short beep tone every 3 seconds) after dialing.	Set Fax Parameter No. 20 (Silent Detection) to "Valid".Or, instruct the calling party to press * twice on their touch-tone phone during the OGM to start up your fax machine remotely.	33
	Cannot retrieve message from the answering machine remotely, the fax machine always starts up after the command code is entered.	Set Fax Parameter No. 20 (Silent Detection) to "Invalid".	33
	Cannot receive a fax message, but can record voice message.	Check your outgoing message, if it is too long, the calling fax machine may have timed out. Try to shorten your outgoing message to less than 15 seconds, or ask the calling party to program your telephone number in their fax machine with 3 pauses and a "#" at the end. (ex. 5551212 PAUSE PAUSE PAUSE #)	--

Troubleshooting

Mode	Symptom	Cause / Action	page
TAM Interface Trouble In Unattended Fax Mode (OUT Mode)	Fax machine will not start to receive with the telephone answering machine in the auto-answer mode.	Increase the ring count for detection on the telephone answering machine.	--

Information Codes

When something unusual occurs, the display may show one of the Information Codes listed below. These will help you to identify and correct the problem.

Info. Code	Meaning	Action	page
001	Recording paper jammed when feeding from the Paper Tray.	Remove the jammed paper.	101
007	Recording paper did not completely exit out of machine.	Remove the Drum Unit/Toner Cartridge Assembly Cartridge and remove the jammed paper.	101
010	No recording paper.	Load the recording paper.	17
030	Document is misfeeding.	1. Reload the document properly. 2. Remove the document jam. 3. Adjust ADF.	37 102 105
031	Document paper is too long or jammed. Document length exceeds 78.8 inches (2 meters).	1. Reload the document properly. 2. Remove the document jam.	37 102
041	Out of toner.	Replace the Toner Cartridge.	15
043	Toner is getting low.		
044	The Life Expectancy of the Drum Unit has been reached.	Replace the Drum Unit.	15
045	Drum Unit/Toner Cartridge Assembly is not installed.	Install the Drum Unit/Toner Cartridge Assembly.	15
061	ADF Door is open.	Close the ADF Door.	--
400	During initial handshake, receiving station did not respond or communication error occurred.	1. Check with the other party. 2. Reload the document(s) and send again.	--
402	During initial handshake, communication error occurred.	Reload the document(s) and send again.	--
403	No polling capability at the remote side.	Ask remote side to set "POLLED=ON".	--
404/405	During initial handshake, communication error occurred.	Reload the document(s) and send again.	--
407	No confirmation from the receiving station for the previous page sent.	Wait a few minutes and send again.	--
408/409	Remote side confirmation of previous page is illegible.	Wait a few minutes and send again.	--
410	Communication aborted on the transmitting side.	Check with the other party.	--
411	Polling password does not match.	Check the polling password.	66
412	No data from the transmitting side.	Check with the other party.	--
414	Polling password does not match.	Check the polling password.	66
416/417 418	Received data has too many errors.	Check with the other party.	--
420/421	Machine goes to receiving mode, but receives no command from the transmitting side.	1. Remote side misdial. 2. Check with the other party.	--
422/427	Interface is incompatible.	Check with the other party.	--
433/434 459	Communication error occurred while receiving.	Check with the other party.	--
436/490	Received data has too many errors.	Check with the other party.	--

Troubleshooting

Information Codes

Info. Code	Meaning	Action	page
456	<ul style="list-style-type: none"> Unit received a confidential document or was requested to be polled of a confidential document under any of following conditions. <ol style="list-style-type: none"> Not enough space in memory to receive the confidential document. Confidential Mailbox is full. While printing received document(s). Unit was requested to relay a document. 	<ol style="list-style-type: none"> Print a File List and check the contents. Wait until unit finishes printing. 	--
494	Communication error occurred while receiving.	Check with the other party.	--
495	Telephone line disconnected.	Check with the other party.	--
501/502	Communication error occurred using the internal V.34 Modem.	Check with the other party.	--
540/541 542 543/544	Communication error occurred while transmitting.	<ol style="list-style-type: none"> Reload the document(s) and send again. Check with the other party. 	--
550	Telephone line disconnected.	Check with the other party.	--
554/555	Communication error occurred while receiving.	Check with the other party.	--
570	A Remote Diagnostic or Firmware Update command was received, while the Remote Diagnostic parameters are not set.	Check the settings of the Fax Parameters No. 51 and 52.	35
580	Sub-Address transmission to a unit that has no Sub-Address function.	Check the remote station.	--
581	Sub-Address Password transmission to a unit that has no Password Sub-Address function.	Check the remote station.	--
601	ADF Door was opened during ADF transmission.	Close the ADF Door and send again.	102
623	No document loaded on the ADF.	Reload the document(s) and send again.	--
630	Redial was not successful due to a busy line.	Reload the document(s) and send again.	--
631	During dialing, STOP was pressed.	Reload the document(s) and send again.	--
634	Redial was not successful due to no response from the called station or wrong number dialed. Note: If busy tone was not detected, the machine will only redial once.	Check the telephone number and send again.	--
638	Power failure occurred during the communication.	Check the power cord and plug.	18
870	Memory overflow occurred while storing document(s) into memory for transmission.	Transmit document(s) without storing into memory.	46
887	Power failure occurred.		94

NOTE

- After identifying the problem and verifying the recommended action, if the information Codes keep reoccurring or for help on Information Codes that appear on your machine but are not listed above, please contact your local Panasonic Authorized Dealer.

Clearing a Recording Paper Jam

If the recording paper becomes jammed in the machine, the display will show an Information Code 001 or 007.

To clear the jam, Info. Code 001

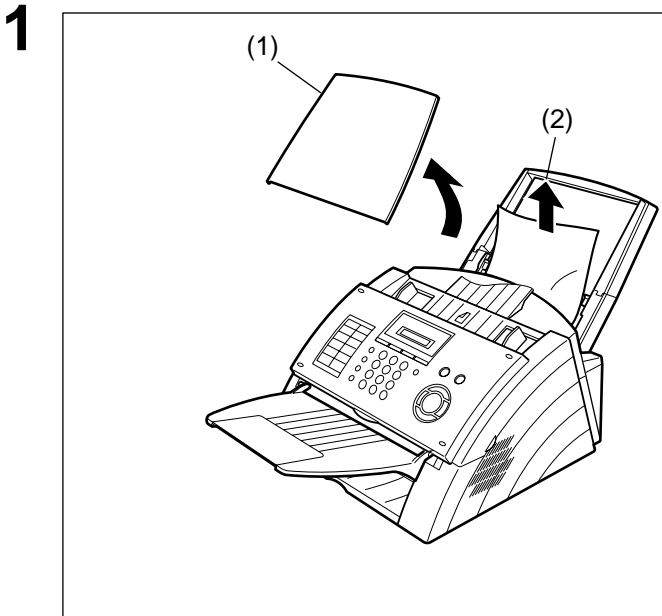

- (1) Remove the Paper Tray Cover.
- (2) Remove the jammed or wrinkled paper.

To clear the jam, Info. Code 007

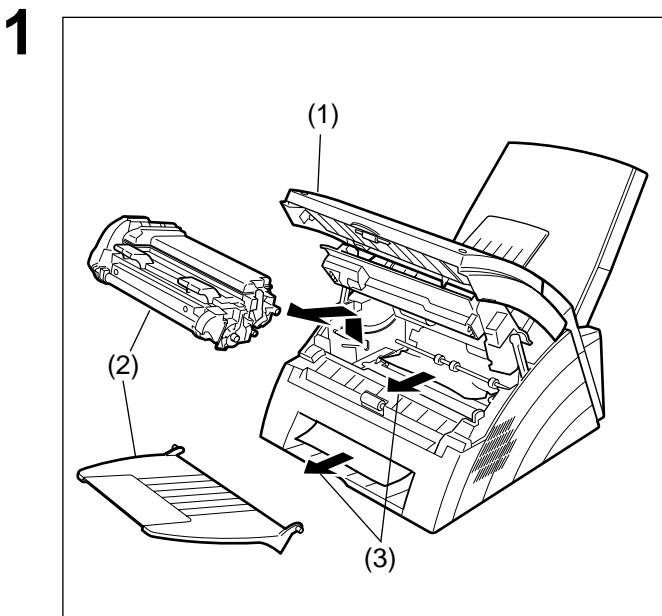

- (1) Open the ADF Door and Printer Cover.
- (2) Remove the Drum Unit/Toner Cartridge Assembly and Document Return Tray.
- (3) Remove the jammed paper.

NOTE

1. The Recording Paper Jam message display is reset only by opening and closing of the Printer Cover.

Troubleshooting

Clearing a Document Jam

If a document becomes jammed in the machine, the display will show the Information Code 030 or 031.

To clear the jam

1

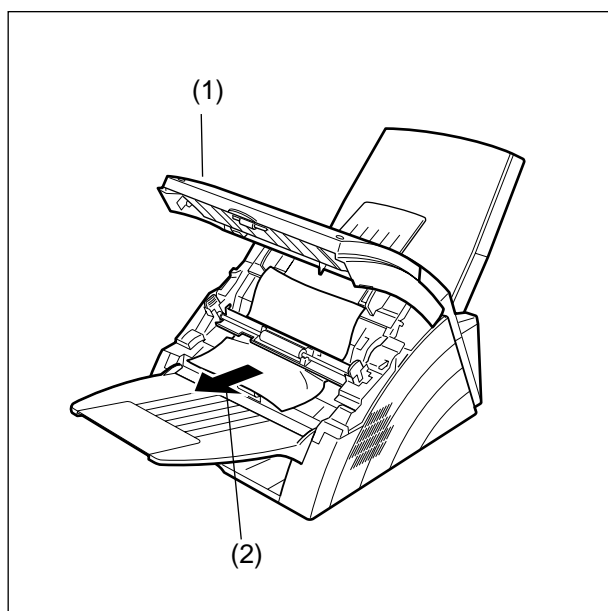

(1) Open the ADF Door.

(2) Remove the jammed document.

Cleaning the Document Scanning Area

If the receiving party reports that the received documents were black, or contained black lines, try making a copy on your unit to verify. If the copy is black or has black lines, the document Scanning Area is probably dirty and must be cleaned.

To clean the Scanning Area

1

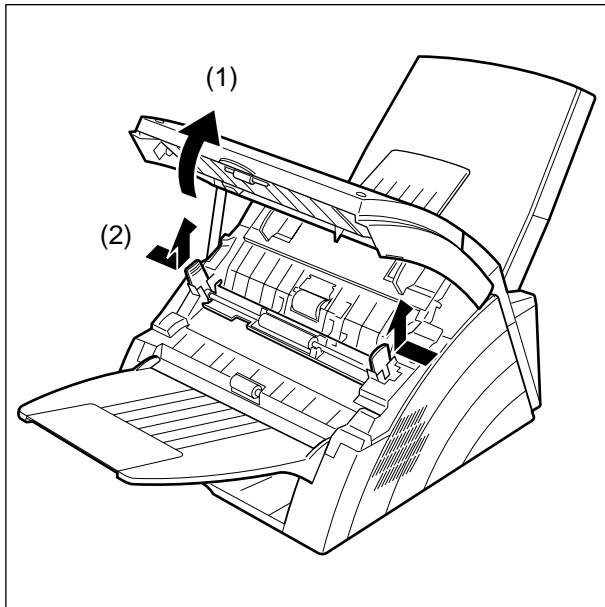

- (1) Open the ADF Door.
- (2) Release the Scanning Guide Levers on both sides.

2

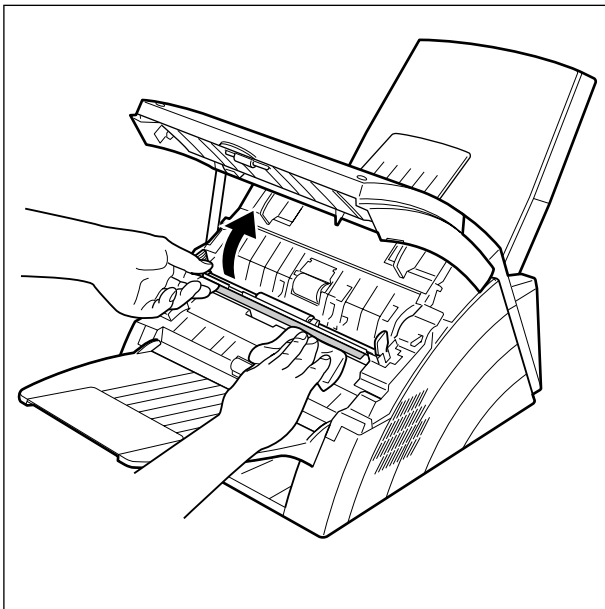

Wipe the Scanning Area and Roller gently with a soft cloth gauze saturated with ethyl alcohol. Be sure to use a clean cloth, the scanning area can be easily scratched.

Troubleshooting

Cleaning the Printer Roller

If you find toner on the back of the recording paper, the printer roller in the Fuser unit is probably dirty.

To clean the rollers

1

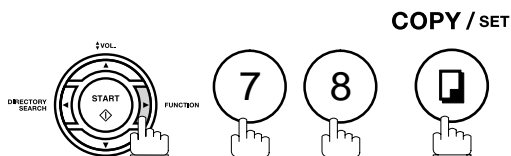

MAINTENANCE (1-9)

2

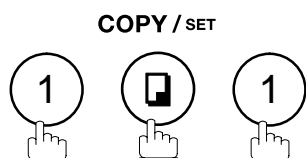

* PRINTING *

The machine will print out 3 Cleaning Charts.
Then, return to standby.

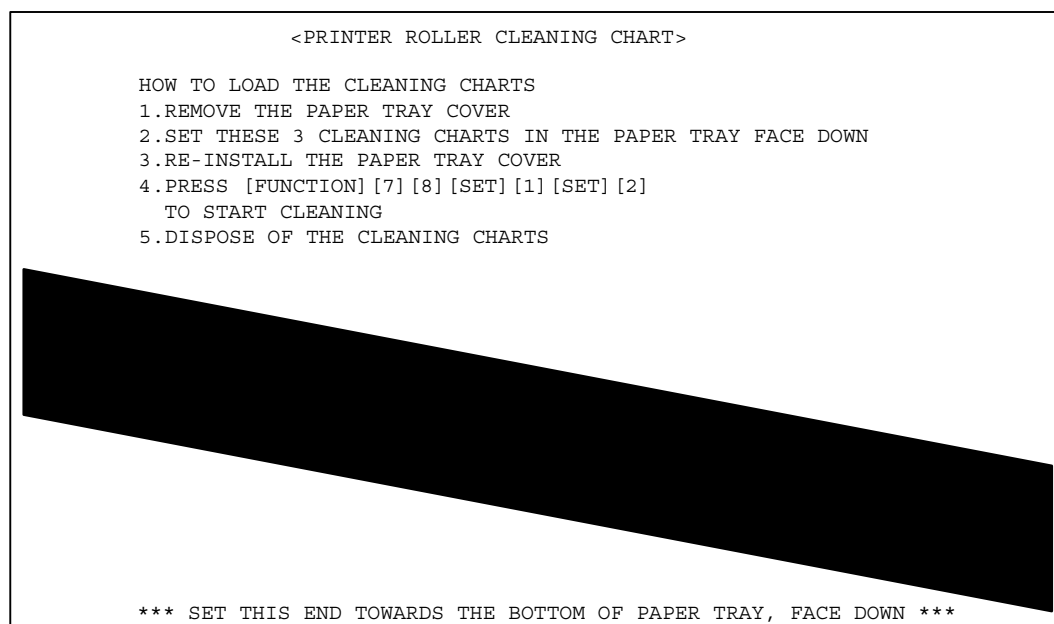

3

Load the Cleaning Charts into the Paper Tray face down.

4

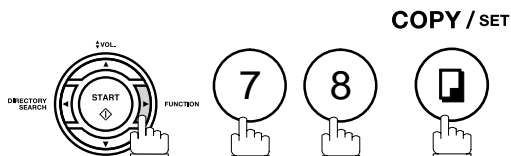

MAINTENANCE (1-9)

5

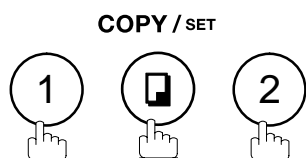

* CLEANING *

The Machine will feed out the charts and clean the printer roller.

Adjusting the Automatic Document Feeder (ADF)

If document misfeeding occurs frequently, we suggest you adjust the ADF.

To adjust the ADF

1

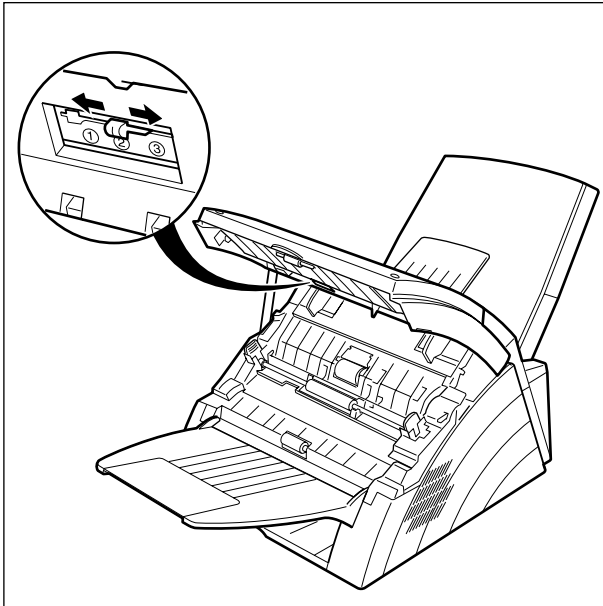

Slide the Pressure Adjusting Lever to the desired position depending on the condition.

Position	Condition
①	To prevent no feed trouble
②	Standard position
③	To prevent multiple feed trouble

Troubleshooting

Checking the Telephone Line

If you do not hear a dial tone when the **MONITOR** key is pressed or the incoming call does not ring on your machine (no automatic receive).

1

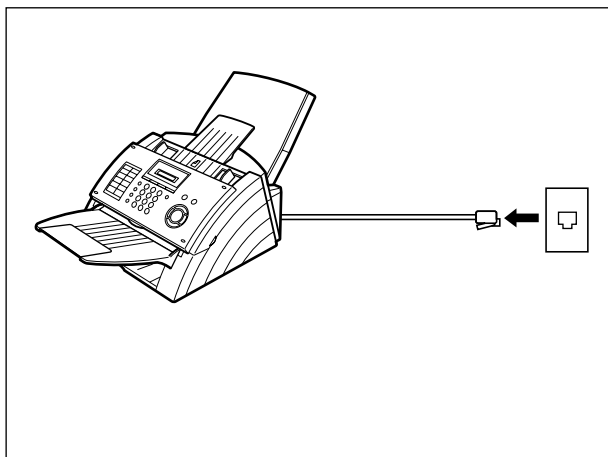

Unplug the Telephone Line Cable from the telephone jack that was supplied by the telephone company.

2

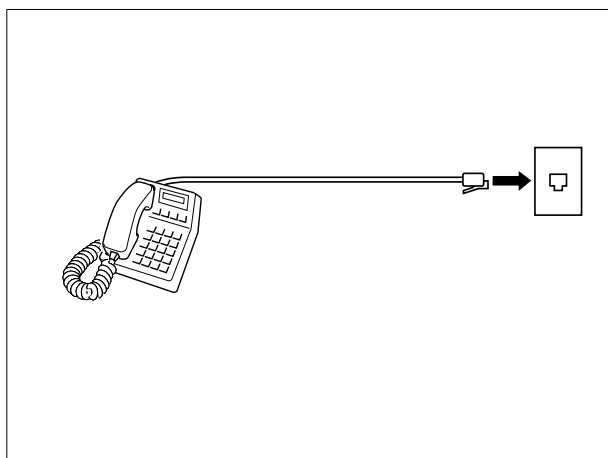

Plug a different regular telephone into the same telephone jack.

3

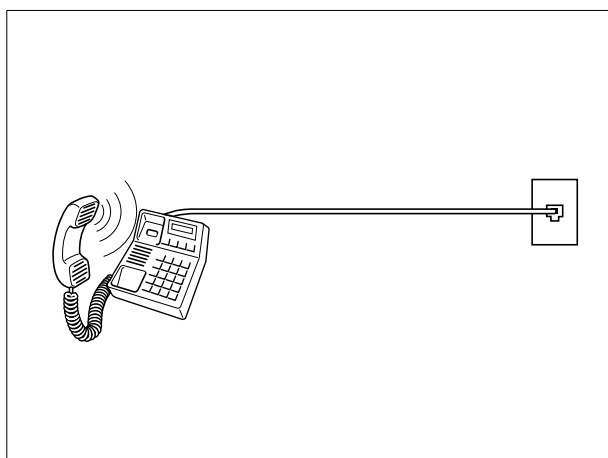

Check for dial tone through the handset. If there is still no dial tone, report it to your local telephone company.

or

Call from another telephone to this number. If the telephone does not ring, report it to your local telephone company.

Specifications

Compatibility	ITU-T Group 3		
Coding Scheme	MH, MR, MMR (Conforms to ITU-T Recommendations)		
Modem Type	ITU-T V.34, V.17, V.29, V.27 ter and V.21		
Modem Speed	33600 - 2400 bps		
Document Size	Max. : 10.1 x 78.7 in (257 x 2000 mm) (with operator's assistance) Min. : 5.8 x 5.0 in (148 x 128 mm)		
Document Thickness	Single page : 0.0024 - 0.0060 in (0.06 - 0.15 mm) Multiple pages : 0.0024 - 0.0039 in (0.06 - 0.10 mm)		
ADF Capacity (Automatic Document Feeder)	Built-in, up to 20 Sheets		
Scanning Method	Sheet Feeding with CIS type image sensor		
Effective Scanning Width	8.3 in (212 mm)		
Scanner Resolution		Horizontal	Vertical
	Standard	203 pels/inch (8 pels/mm)	98 lines/inch (3.85 lines/mm)
		x	x
	Fine	203 pels/inch (8 pels/mm)	196 lines/inch (7.7 lines/mm)
		x	x
	Super Fine	203 pels/inch (8 pels/mm)	391 lines/inch (15.4 lines/mm)
		x	x
Recording Method	Laser printer		
Recording Paper	Plain Paper		
Recording Paper Size	Letter, A4 or Legal		
Printer Resolution	Fax/Copy Mode : 406 x 391 dpi Printer Mode : 600 x 600 dpi		
Effective Recording Size	Letter	: 8.2 x 10.7 in (208 x 271 mm)	
	A4	: 8.0 x 11.4 in (202 x 289 mm)	
	Legal	: 8.2 x 13.7 in (208 x 348 mm)	

Print Margin

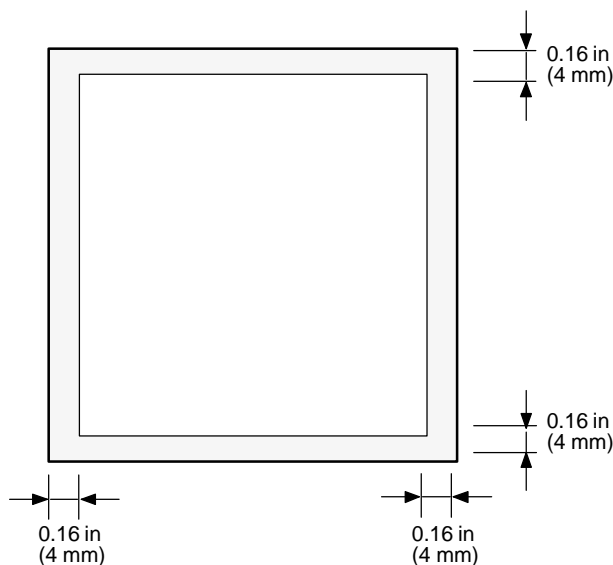

Specifications

Recording Paper Capacity	Approx. 150 sheets (using 20 lbs paper)
One-Touch/Abbreviated Dialing Memory Capacity	100 stations (including 16 One-Touch keys and 2 Program keys) Each station can register up to 36 digits for each telephone number (including pauses and spaces) and up to 15 characters for each station name
Image Memory Capacity	60 pages (Based on ITU-T Image No.1 chart using Standard Resolution)
Power Supply	108-132 VAC, 47-63 Hz, Single Phase
Power Consumption	Standby (Sleep Mode : On) Less than 0.7 Wh Standby (Energy-Saver : On) Approx. 5.5 Wh Standby (Energy-Saver : Off) Approx. 17 Wh [Room temperature : 77°F (25°C)] Transmission Approx. 17 W Reception Approx. 450 W Copy Approx. 450 W Maximum Approx. 470 W
Dimensions	14.0 (W) x 14.3 (D) x 8.7(H) in (355 x 364 x 220 mm) (excluding Projections and optional Paper Tray)
Weight	Approx. 16.1 lbs (Approx. 7.3 kg) (excluding consumable supplies and options)
Operating Environment	Temperature : 50 to 95°F (10 to 35°C) Relative Humidity : 15 to 70%
FCC Registration Number	BTLMUL-44605-FA-E
Ringer Equivalence	3.3B

Recording Paper Specifications

In general, most photocopy papers will also work very well. There are many "name" and "generic" brands of paper available. We recommend that you test various papers until you obtain the results you are looking for.

The following table summarizes the major specifications to consider when selecting white or colored paper.

Basic Weight	16 to 24 lb (60 to 90 g/m ²)
Cut Edge Conditions	Cut with sharp blades, no visible frayed edges
Grain	Long grain
Moisture Content	3.7% to 5.3% by weight
Opacity	88% minimum
Packing	Poly laminated moisture-proof ream wrap
Sizes	Letter : 8.5 x 11 in (216 mm x 279 mm) A4 : 8.3 x 11.7 in (210 mm x 297 mm) Legal : 8.5 x 14 in (216 mm x 356 mm)
Type	Cut sheet

NOTE

1. *It is possible that the paper could meet all of the specifications listed above and still not print well because of the variations in paper manufacturing. Therefore, we recommend that you test the paper thoroughly before purchasing large quantities.*

Options and Supplies



Please contact your local Panasonic dealer for availability.

A. Options:

Order No.	Picture	Description
UE-403167		Handset Kit

B. Supplies:

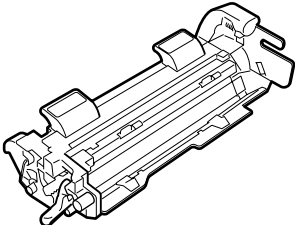
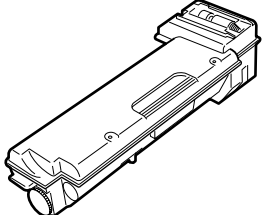
Order No.	Picture	Description
UG-3220		Drum Unit
UG-3221		Toner Cartridge

FCC Notice for User in USA

WARNING

This equipment has been tested and found to comply with the limits for a Class B digital device, pursuant to Part 15 of the FCC Rules. These limits are designed to provide reasonable protection against harmful interference in a residential installation. This equipment generates, uses and can radiate radio frequency energy and, if not installed and used in accordance with the instructions, may cause harmful interference to radio communications. However, there is no guarantee that interference will not occur in a particular installation. If this equipment does cause harmful interference to radio or television reception, which can be determined by turning the equipment off and on, the user is encouraged to try to correct the interference by one of the following measures:

1. Reorient or relocate the receiving antenna.
2. Relocate fax machine with respect to receiver or other equipment.
3. Connect fax machine into outlet on a circuit different from that to which the receiver is connected.
4. Consult the dealer or an experienced radio/TV technician for help.

Warning: To assure continued compliance, use only shielded interface cable when connecting the facsimile machine parallel interface port to host computer. Also, any changes or modifications not expressly approved by the party responsible for compliance could void the user's authority to operate this equipment.

This device complies with Part 15 of the FCC Rules. Operation is subject to the following two conditions: (1) This device may not cause harmful interference, and (2) this device must accept any interference received, including interference that may cause undesired operation.

Responsible Party: Matsushita Electric Corporation of America
One Panasonic Way, Secaucus, NJ 07094

Technical Support: Panasonic Document Imaging Company/Technical Support Department
Two Panasonic Way, Secaucus, NJ 07094
1-800-225-5329
Email: consumerproducts@panasonic.com

Ask your telephone company or installer to install the jack suitable for your device if such is not available.

A FCC Compliant telephone cord and modular plug is provided with this equipment. This equipment is designed to be connected to the telephone network or premises wiring using a compatible modular jack that is Part 68 compliant.

The REN is useful to determine the quantity of devices you may connect to your telephone line and still have all of those devices ring when your telephone number is called. In most, but not all areas, the sum of the REN's of all devices connected to one line should not exceed five (5.0). To be certain of the number of devices you may connect to your line, as determined by the REN, you should contact your local telephone company to determine the maximum REN for your calling area.

If your telephone equipment causes harm to the telephone network, the Telephone Company may discontinue your service temporarily. If possible, they will notify you in advance. But if advance notice isn't practical, you will be notified as soon as possible. You will be informed of your right to file a complaint with FCC.

Your telephone company may make changes in its facilities, equipment, operations or procedures that could affect the proper functioning of your equipment. If they do, you will be notified in advance to give you an opportunity to maintain uninterrupted telephone service.

If you experience trouble with this telephone equipment, please contact the manufacturer's authorized service agency for information on obtaining service or repairs. The telephone company may ask that you disconnect this equipment from the network until the problem has been corrected or until you are sure that the equipment is not malfunctioning.

FCC Notice for User in USA

This equipment is hearing aid compatible.

For protection against the risk of electric shock, always disconnect all cables from the wall outlet before servicing, modifying or installing the equipment.

This equipment may not be used on coin service provided by the telephone company nor connected to party lines. Connection to party line service is subject to state tariffs. (Contact the state public utility commission, public service commission or corporation commission for information.)

The Telephone Consumer Protection Act of 1991 makes it unlawful for any person to use a computer or other electronic device to send any message via telephone facsimile machine unless such message clearly contains in a margin at the top or bottom of each transmitted page or on the first page of transmission the following information:

1. Date and Time of transmission; and,
2. Identification of either business, business entity or individual sending the message: and,
3. Telephone number of either the sending machine, business, business entity or individual.

In order to program this information into your facsimile machine, you should refer to page number 22 and 25 in this Operating Instructions to complete the steps.

Example of Header Format (LOGO, ID Number setting)

OCT-12-2001 09:00	PANASONIC	201 348 7000	P.01/05
↑	↑	↑	
1) Date and Time	2) LOGO	3) ID Number	



As an ENERGY STAR[®] Partner, Panasonic has determined that this product meets the ENERGY STAR[®] guidelines for energy efficiency.

This voluntary program specifies certain energy consumption and usage standards. This product will automatically "power down" after a specified period of non-use. The use of this ENERGY STAR[®] compliant product will reduce energy consumption and ultimately benefit the environment.

The default functions can be adjusted depending on your office requirements. Please see your authorized Panasonic dealer for more details.

NOTE

1. This equipment complies with Part 68 of the FCC Rules. On the rear panel of this equipment is a label that contains, among other information, the FCC Registration Number and Ringer Equivalence Number (REN) for this equipment. You must, upon request, provide this information to your telephone company.

Notice to User in Canada

NOTICE

This equipment meets telecommunications network protective, operational and safety requirements as prescribed in the appropriate Terminal Equipment Technical Requirements document(s). This is confirmed by marking the equipment with the Industry Canada certification number. The Department does not guarantee the equipment will operate to the user's satisfaction.

Before installing this equipment, users should ensure that it is permissible to be connected to the facilities of the local telecommunications company. The equipment must also be installed using an acceptable method of connection. The customer should be aware that compliance with the above conditions may not prevent degradation of service in some situations.

Repairs to certified equipment should be made by an authorized Canadian maintenance facility designated by supplier. Any repairs or alterations made by the user to this equipment, or equipment malfunctions, may give the telecommunications company cause to request the user to disconnect the equipment.

Users should ensure for their own protection that the electrical ground connections of the power utility, telephone lines and internal metallic water pipe system, if present, are connected together. This precaution may be particularly important in rural areas.

CAUTION

Users should not attempt to make such connections themselves, but should contact the appropriate electric inspection authority, or electrician, as appropriate.

NOTICE

The ringer equivalence number (REN) assigned to each terminal device provides an indication of the maximum number of terminals allowed to be connected to a telephone interface. The termination on an interface may consist of any combination of devices subject only to the requirement that the sum of the ringer equivalence numbers of all the devices does not exceed 5.

Notice to User in Canada

Avis

L'étiquette de Industrie Canada identifie le matériel homologué. Cette étiquette certifie que le matériel est conforme à certaines normes de protection, d'exploitation et de sécurité des réseaux de télécommunications. Le Ministère n'assure toutefois pas que le matériel fonctionnera à la satisfaction de l'utilisateur. Avant d'installer ce matériel, l'utilisateur doit s'assurer qu'il est permis de le raccorder aux installations de l'entreprise locale de télécommunication. Le matériel doit également être installé en suivant une méthode acceptée de raccordement.

L'abonné ne doit pas oublier qu'il est possible que la conformité aux conditions énoncées ci-dessus n'empêche pas la dégradation du service dans certaines situations. Les réparations de matériel homologué doivent être effectuées par un centre d'entretien canadien autorisé désigné par le fournisseur. La compagnie de télécommunications peut demander à l'utilisateur de débrancher un appareil à la suite de réparations ou de modifications effectuées par l'utilisateur ou à cause de mauvais fonctionnement. Pour sa propre protection, l'utilisateur doit s'assurer que tous les fils de mise à la terre de la source d'énergie électrique, des lignes téléphoniques et des canalisations d'eau métalliques, s'il y en a, sont raccordé ensemble. Cette précaution est particulièrement importante dans les régions rurales.

Avertissement

L'utilisateur ne doit pas tenter de faire ces raccordements lui-même; il doit avoir recours à un service d'inspection des installations électriques, ou à un électricien, selon le cas.

Avis

L'indice d'équivalence de la sonnerie (IES) assigné à chaque dispositif terminal indique le nombre maximal de terminaux qui peuvent être raccordés à une interface. La terminaison d'une interface téléphonique peut consister en une combinaison de quelques dispositifs, à la seule condition que la somme d'indices d'équivalence de la sonnerie de tous les dispositifs n'excède pas 5.

Glossary

ABBR. No. (Abbreviated Number)	The ability to store full phone numbers into the dialer and then utilizing a short series of keystrokes to speed dial that number in the future.
Access Code	A 4-digit programmable access code that prevents unauthorized operation of your Fax.
ADF (Automatic Document Feeder)	The mechanism that delivers a stack of document pages to the scanner one page at a time.
Automatic Reception	The mode that allows you to receive fax documents without user intervention.
Auto Print Reduction	The method of automatically reducing a received document so that it can be printed onto a standard size piece of plain paper. For example, your machine will reduce an incoming Legal size page to 75% of its original size so it could fit on a Letter size page.
BPS (Bits Per Second)	The amount of data that is transmitted over the phone line. Your machine can start at each Max. Modem speed and automatically steps down to suitable speed depending on the phone line condition and the receiving machines capabilities. (Max. Modem Speed: 33,600 BPS)
C.C.I.T.T.	Consultative Committee on International Telegraph and Telephone. This organization has presently developed four groups of industry standards that insure facsimile compatibility.
Character ID	A programmed proprietary code name that allows up to 16 alphanumeric characters identifying your facsimile machine.
Character Keys	The keys that are used to enter letters and symbols for various programming functions.
Coding Scheme	The data compression method used by facsimile machines. Your machine utilizes Modified Huffman (MH), Modified Read (MR) and Modified Modified Read (MMR) coding schemes.
COMM. JOURNAL	Refers to either the Communication Journal, Relay Transmission Report, or the Confidential XMT Report.
Contrast	Signifies the scanning sensitivity in terms of lightness and darkness of your original transmitting pages.
DDD (Direct Distance Dialing)	A telephone service that allows unassisted dialing, no operator assistance is required.
Deferred Transmission	The ability to send documents to other stations at a later time.
Direct Dialing	The method of dialing where you enter the entire telephone number through the keypad.
Directory Search Dialing	Allows you to dial a full telephone number by searching the station's name entered in the One-Touch keys or Abbreviated dialing numbers.
Directory Sheet	The list that contains the station names that are programmed into your unit.
DTMF (Dual Tone Multi-Frequency)	Dialing method that sends a different set of frequencies for each digit of the telephone keypad. Commonly refers to touch tone dialing.
ECM (Error Correction Mode)	The ability to correct transmission errors as detected during the transmitting phone call.
Energy-Saver Mode	Saves energy by consuming less power than when in standby mode by turning off the fuser unit after the specified time.
FAX Forward	The ability to forward all incoming faxes to the registered station in the specified ABBR No.
FAX Parameter List	The list that contains the home FAX parameters settings that you have programmed into your machine.
FAX/TEL Auto Switching	The ability to share a single telephone line for both fax and voice usage.
F.C.C.	Federal Communications Commission. The U.S. Government organization that regulates communications originating or terminating in the United States.
File	A task that has been stored into the memory of your unit. Examples are deferred transactions.
Fixed Print Reduction	The method that allows you to determine one reduction rate, such as 75%, for all incoming documents.

Glossary

Function	The control panel key that will be utilized to begin an operation or configuration of a feature.
G3 Mode (Group 3)	Refers to the standards and transmission capabilities of the current generation of facsimile machines.
Group Dialing	The ability to program many telephone numbers into a single station so that many locations can be dialed in sequence utilizing a single keystroke.
Halftone	A scanning technique to distinguish levels of gray from black and white. Your machine can detect up to 64 levels of gray in halftone mode.
Handshaking	The exchange of a group of control signals that communicate between the transmitter and receiver. These signals determine the condition at which communication can occur.
Header	A row of information that is transmitted by the sending machine and printed on the top of each page by the receiving unit. This identifies the transmitting unit and information about the transmission, such as time and date.
IN/OUT Mode	IN (Attended reception) and OUT (Unattended reception) mode can be easily changed by just pressing the OUT button. When IN or OUT mode is selected, the reception mode will be set according to the setting in the Fax Parameter 15 and 16. IN Mode : TEL (Fax manual reception) : FAX/TEL Auto Switch OUT Mode : FAX (Fax automatic reception) : TAM I/F
ITU-T	International Telecommunication Union - Telecommunication, formerly known as C.C.I.T.T.
ITU-T Image No.1	An industry standard document that allows comparisons of the transmission speeds and capabilities of facsimile machines.
ID	A programmable address of up to 20 digits identifying your machine.
Image Memory Capacity	This signifies the amount of memory available in your unit capable of storing pages of documents. All page units of measure are based on the ITU-T Image No.1.
Individual Transmission Journal	A report that is printed by the transmitting unit stating information regarding the last document transaction.
Industry Canada (D.O.C.)	Department of Communications. The Canadian Government organization that regulates communications originating or terminating in Canada.
Information Code	A code that is internally generated by your Fax machine stating a specific operational error or machine failure.
Journal	A report that is printed by your unit listing the last 32 transactions.
Keypad	A group of numeric keys located on your control panel.
LCD	Liquid Crystal Display. The display area of your machine.
Logo	Your programmed company name or identification up to 25 alphanumeric characters.
Manual Reception	A mode that requires operator intervention to receive an incoming document.
Memory Transmission	The documents are scanned into memory before actual connection to the phone line for transmission.
Modem	A device that converts signals from your fax machine into signals that can be transmitted over telephone lines.
Multi-Station Transmission	The ability to broadcast the same set of documents to a programmed number of locations.
Off-Hook Dialing	The direct dialing of a telephone number with the handset out of the cradle or "off the hook."
On-Hook Dialing	The direct dialing of a telephone number with the handset in the cradle or "on the hook."
One-Touch Dialing	The ability to dial an entire telephone number by pressing one key.
Overlap Printing	Documents too long to be reduced are automatically printed on two pages with approximately 10 mm overlap.
Panasonic Super Smoothing	An electronic image enhancement (Panasonic Super Smoothing) that will create a particular pattern for the improvement of copy quality.

Polling	The ability to retrieve a document(s) from another facsimile machine.
Polling Password	A 4-digit programmed code that enables the security of a document(s) being polled.
Power Saver Mode	To reduce the power consumption of the machine in standby, select the time period to turn OFF the high temperature fuser unit when the printer is idle.
Print Reduction Modes	The methods used to determine how an incoming document will be reduced to print onto the paper loaded in your machine.
Program Keys	Keys that are defined for storing a sequence of stations to be dialed or polled.
Protocol	A protocol is the special set of rules for communicating that the end points in a telecommunication connection use when they send signals back and forth. Both end points must recognize and observe the protocol.
PSTN	Public Switched Telephone Network. Network of interconnected switching equipment and transmission facilities.
Resolution	Relates to the number of dots scanned or printed per certain square. The quality of the image increases as the number of dots per certain square increases.
Sleep Mode	The lowest power state that the machine enters after the specified time without actually turning off.
Station Name	Alphanumeric ID which can be programmed for each One-Touch dialing and Abbreviated dialing number.
Stored Documents	Documents that have been scanned and now are stored in your machine's memory.
Sub-Address	ITU-T recommendation for further routing, forwarding or relaying of incoming faxes.
Sub-Address Password	ITU-T recommendation for additional security that corresponds to the Sub-Address.
Substitute Memory Reception	Your machine's ability to store an incoming document into its memory, when it runs out of recording paper or toner.
Transmission Reservation	The ability to preset a telephone number so that you may reserve a transmission while your unit is performing another function.
TAM Interface	A capability of your unit to be connected and operate with a Telephone Answering Machine (TAM).
Transmission Password	A 4-digit password that is checked when a document is transmitted.
User Parameter	Programmed parameters that provide information to other stations. Examples are logo, character ID, date and time.
View Mode - File List	Allows you to view the brief contents of the memory files through the LCD display without having to print the Memory File List.
View Mode - Journal	Allows you to view the brief contents of the journal through the LCD display without having to print the journal.

ITU-T Image No. 1

All specifications are based on the ITU-T Image No. 1 (The sample shown below is not to scale).



THE SLEREXE COMPANY LIMITED

SAPORS LANE - BOOLE - DORSET - BH 25 8 ER

TELEPHONE BOOLE (945 13) 51617 - TELEX 123456

Our Ref. 350/PJC/EAC

18th January, 1972.

Dr. P.N. Cundall,
Mining Surveys Ltd.,
Holroyd Road,
Reading,
Berks.

Dear Pete,

Permit me to introduce you to the facility of facsimile transmission.

In facsimile a photocell is caused to perform a raster scan over the subject copy. The variations of print density on the document cause the photocell to generate an analogous electrical video signal. This signal is used to modulate a carrier, which is transmitted to a remote destination over a radio or cable communications link.

At the remote terminal, demodulation reconstructs the video signal, which is used to modulate the density of print produced by a printing device. This device is scanning in a raster scan synchronised with that at the transmitting terminal. As a result, a facsimile copy of the subject document is produced.

Probably you have uses for this facility in your organisation.

Yours sincerely,

Phil.

P.J. CROSS
Group Leader - Facsimile Research

A

- ABBR Number List 88, 89
- Abbreviated Dialing Numbers 27
- Access Code 73
- ADF Capacity 107
- Automatic Document Feeder 37
- Automatic Reduction 61

C

- Character ID 24
- Communication Journal (COMM. Journal) 39, 86
- Contrast 38
- Control Panel 11
- Copy 64

D

- Date and Time 22
- Deferred Transmission 65
- Diagnostic Password 35
- Dialing Method (Tone or Pulse) 20, 33
- Direct Transmission 46
- Directory Search Dialing 49
- Directory Sheet 31
- Distinctive Ring Detector (DRD) 75
- Document Jam 102
- Document Misfeeding 105
- Document Size 107
- Document Thickness 107
- Drum Unit 15

F

- Fax / Tel Auto Switching Mode 58
- Fax Forward 78
- FAX Parameter List 92
- Fax Parameter Table 33
- Firmware Update 9
- Fixed Reduction 61
- Function Key List 9

G

- Group Dialing 68

H

- Header Format 33
- Header Print 33

I

- ID Number 25
- Image Memory Capacity 108
- IND. XMT Journal 83
- ITU-T Image No. 1 118

J

- Journal 82

K

- Key/Buzzer Volume 33

L

- Loading Documents 36
- LOGO 23

M

- Memory Transmission 41
- Monitor Volume 21

O

- Off-Hook Dialing 50
- One-Touch Keys 27
- One-Touch List 89
- One-Touch/Abbreviated Dialing Numbers 27
- On-Hook Dialing 51
- Operating Environment 108
- Overlap Printing 62

P

- Paper Specifications 109
- Pause 11
- Polling 66
- Polling Password 66
- Power Consumption 108
- Pressure Adjusting Lever 105
- Print Collation 63
- Print Margin 107
- Print Reduction Ratio 61
- Program Keys 68
- Program List 91

R

- Received Time Print 33
- Recording Paper Jam 101
- Redialing 54
- Reduction Ratio 34
- Resolution 38
- Ringer Volume 21

S

- Scanner Resolution 107
- Sub-Address Password 35
- Sub-Addressing 79
- Substitute Memory Reception 63

T

- TAM Interface Mode 59
- Toner Cartridge 15
- Transmission Reservation 52

U

- User Parameters 22

U.S.A. Only

WARRANTY

PANASONIC DOCUMENT IMAGING COMPANY MAKES NO WARRANTIES, GUARANTEES OR REPRESENTATIONS, EXPRESSED OR IMPLIED, TO CUSTOMER WITH RESPECT TO THIS PANASONIC FACSIMILE MACHINE, INCLUDING BUT NOT LIMITED TO, ANY IMPLIED WARRANTY OF MERCHANTABILITY OR FITNESS FOR A PARTICULAR PURPOSE.

PANASONIC DOCUMENT IMAGING COMPANY ASSUMES NO RISK AND SHALL NOT BE SUBJECT TO LIABILITY FOR ANY DAMAGE, INCLUDING, BUT NOT LIMITED TO DIRECT, INDIRECT, SPECIAL, INCIDENTAL OR CONSEQUENTIAL DAMAGES OR LOSS OF PROFITS SUSTAINED BY THE CUSTOMER IN CONNECTION WITH THE USE OR APPLICATION OF THIS PANASONIC FACSIMILE MACHINE. SEE YOUR DEALER FOR DETAILS OF DEALER'S WARRANTY.

For Service, Call: _____

Panasonic Document Imaging Company
A Business Unit of Matsushita Electric Corporation of America
Two Panasonic Way
Secaucus, New Jersey 07094

Panasonic Canada Inc.
5770 Ambler Drive
Mississauga, Ontario L4W 2T3

M0601-2111
DZSD001463-2
November 2001
Printed in Japan