

Panasonic®

Facsimile

Panafax® UF-550/560/770

User's Guide

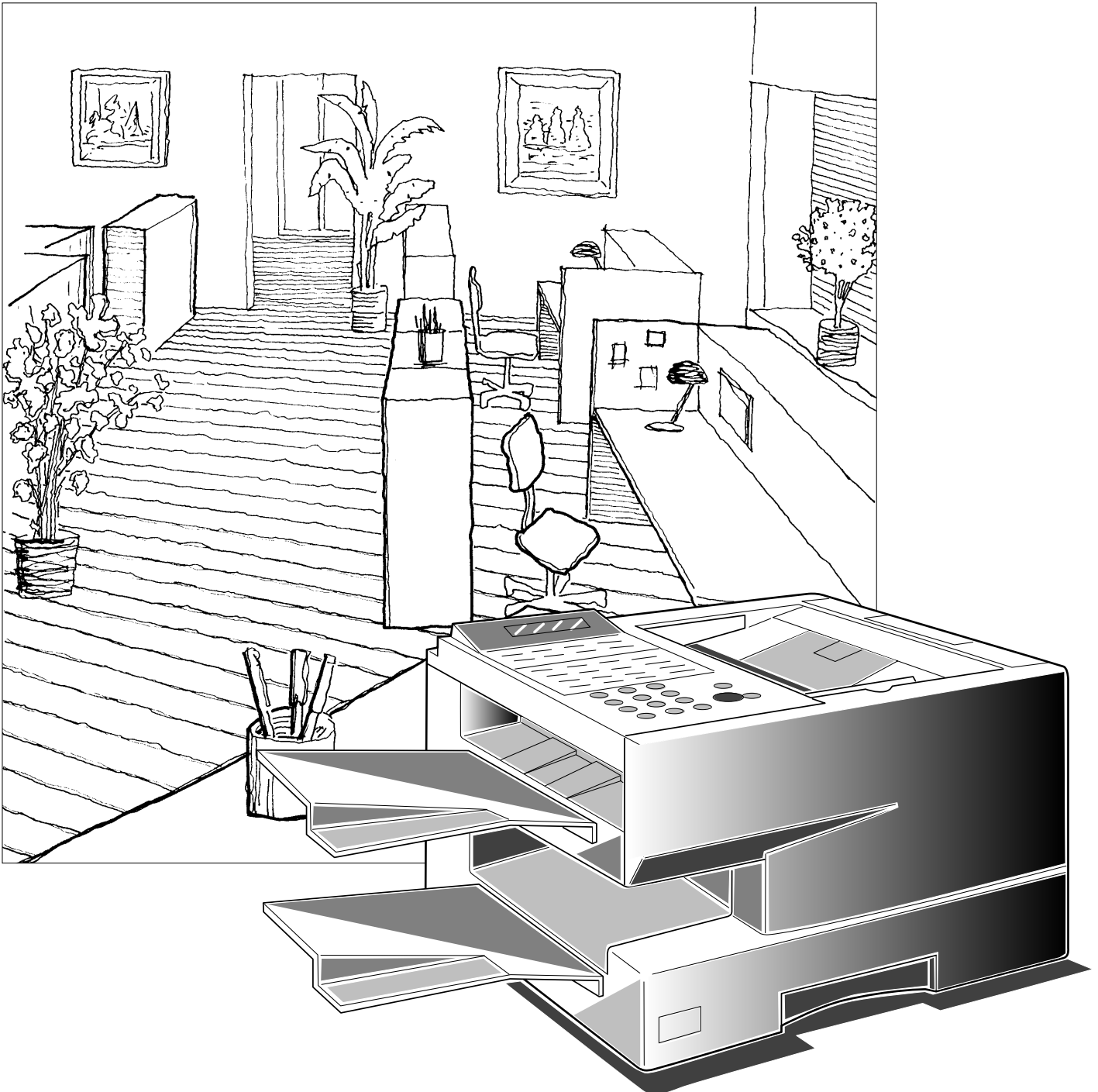

QUICK GUIDE UF-550/560/770

How to Set Documents.

Set the documents face down and adjust the document guides.

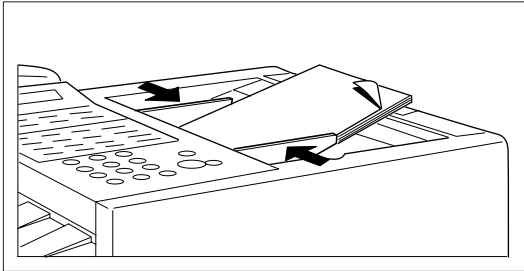

You can set the documents on the ADF (Automatic Document Feeder) up to 50 pages* at one time.

*: (Based on 75 g/m² (0.12 mm) weight A4 size document)
*: (UF-550/560: Up to 30 pages)

The display message is as shown below when the documents are set properly.

ENTER STATION(S)
THEN PRESS START 00%

How to Send Using Manual Dialling.



Set the documents face down.

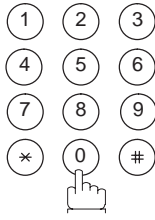

Enter the telephone number.



The document is stored in memory. Then, your machine starts dialling.

How to Send Using One-Touch/Abbreviated Key.



Set the documents face down.

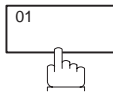

or

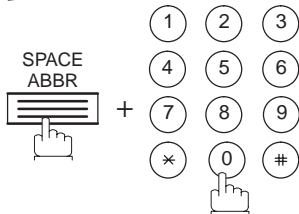

Enter a 2-digit code (00 to 99). (UF-550/560: 01 to 72)

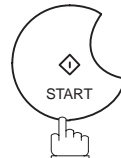

The document is stored in memory. Then, your machine starts dialling.

How to Send without storing into memory.

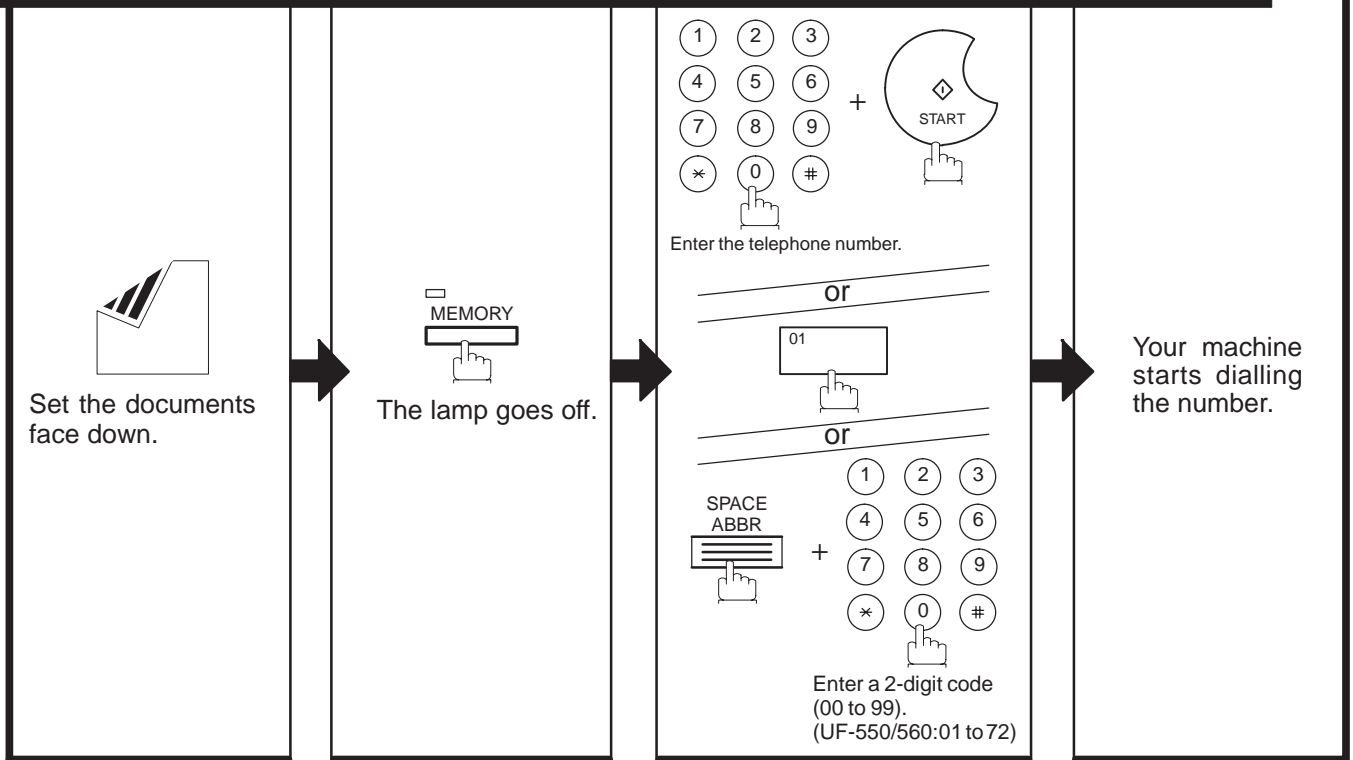

How to Print Journals and Reports.

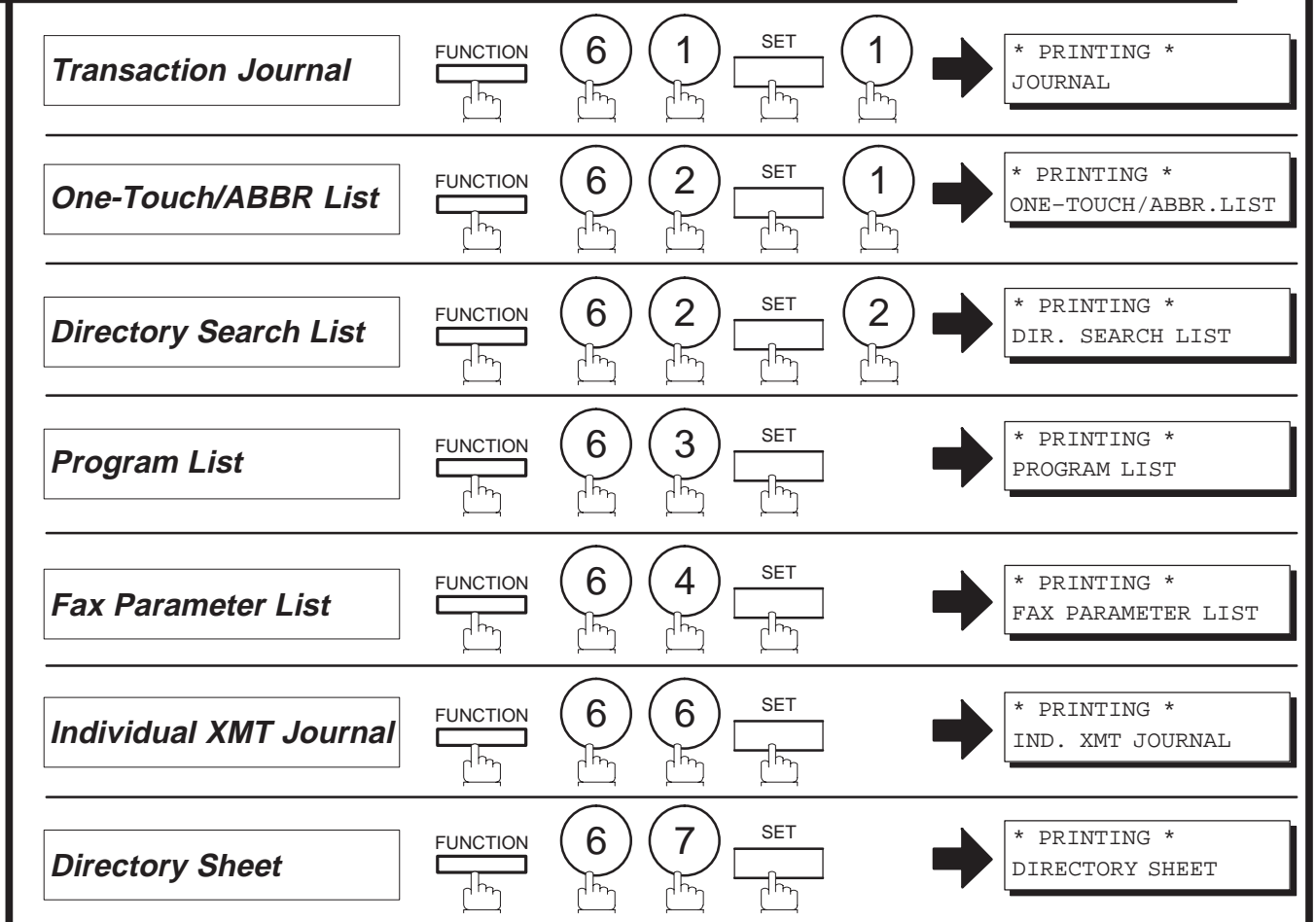

IMPORTANT INFORMATION

When requesting information, supplies, or service always refer to the model and serial number of your machine. The model and serial number plate (Main Name Plate) is located on the machine as shown below. For your convenience, space is provided below to record the information you may need in the future.

Model No. _____ Serial No. _____

Date of Purchase _____

Dealer _____

Address _____

Telephone Number
() - _____

Supplies Telephone Number
() - _____

Service Telephone Number
() - _____

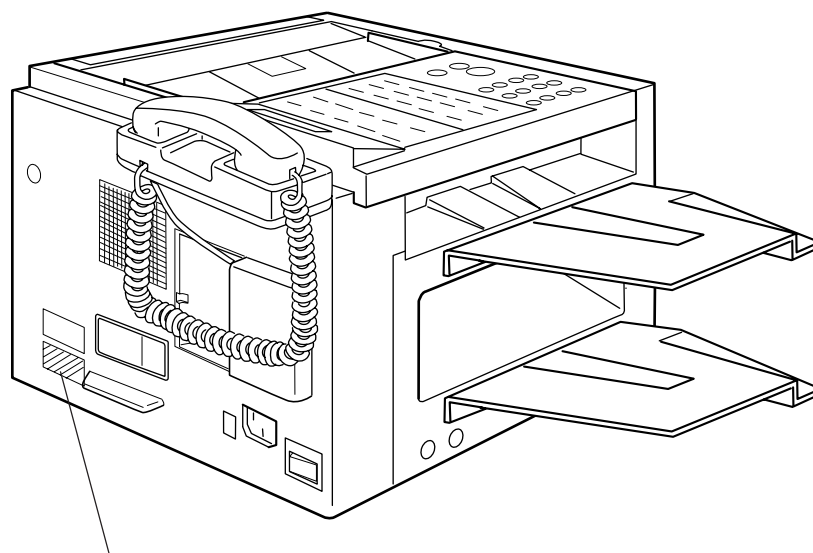

Model and Serial Number

Table of Contents

1	GETTING TO KNOW YOUR MACHINE	
	Introduction	7
	Function Key	8
	External View	9
	Control Panel	10
2	INSTALLING YOUR MACHINE	
	Safety Information	12
	Main Unit and Accessories	14
	Installing the Accessories	15
	Installing the Toner Cartridge	16
	Loading the Recording Paper	18
	Paper Specifications	18
	How to Load the Recording Paper	18
	Connecting the Telephone Line Cord and Power Cord	20
	Setting the Recording Paper Size [For UF-550/560 only]	22
	Setting the Dialling Method (Tone or Pulse)	23
	Adjusting the Volume	24
	Setting the Monitor Volume	24
	Setting the Ringer Volume	24
	User Parameters	25
	Setting the Date and Time	25
	Setting Your LOGO	26
	Setting Your Character ID	27
	Setting Your ID Number (Fax Telephone Number)	28
3	PROGRAMMING YOUR MACHINE	
	One-Touch/Abbreviated Dialling Numbers	29
	Entering One-Touch/Abbreviated Dialling Numbers	29
	Changing or Erasing One-Touch/Abbreviated Dialling Numbers	31
	Printing Out a Directory Sheet	33
	Customizing Your Machine	34
	Setting the Fax Parameters	34
	Fax Parameter Table	35
4	BASIC OPERATIONS	
	Loading Documents	39
	Documents You Can Send	39
	Documents You Cannot Send	39
	How to Load Documents	40
	Basic Transmission Settings	41
	Contrast	41
	Resolution	41
	Halftone	42
	Verification Stamp	42
	Communication Journal (COMM. JOURNAL)	43

Sending Documents	44
Memory Transmission	44
Manual Number Dialling	46
One-Touch Dialling	47
Abbreviated Dialling	48
Directory Search Dialling	49
Multi-Station Transmission (Broadcasting)	50
Direct Transmission	51
Manual Number Dialling (Direct Transmission)	51
One-Touch Dialling (Direct Transmission)	52
Abbreviated Dialling (Direct Transmission)	53
Directory Search Dialling (Direct Transmission)	54
Voice Mode Transmission	55
Off-Hook Dialling	55
On-Hook Dialling	56
Transmission Reservation	57
Memory Transmission Reservation (Dual Access)	57
Direct Transmission Reservation (Priority Transmission Reservation)	58
Redialling	59
Automatic Redialling	59
Manual Redialling	59
Receiving Documents	60
Automatic Reception	60
Manual Reception	60
Print Reduction	61
Selecting the Print Reduction Mode	61
Receiving Oversize Documents	62
Substitute Memory Reception	63
Print Collation Mode	63
Making Copies	64

5 ADVANCED FEATURES

Timer Controlled Communications	65
Deferred Transmission	65
Deferred Polling	66
Polling	67
Setting Polling Password	67
Preparing to be Polled	68
To Poll Documents from Another Station	69
Program Keys	70
Setting for Deferred Transmission	70
Setting for Normal Polling	71
Setting for Deferred Polling	72
Setting for Group Dialling	73
Setting for One-Touch Key	74
Changing or Erasing Program Key Settings	75

Edit File Mode	76
Printing a File List	76
Viewing the Contents of a File List	77
Changing the Start Time or the Station of a File	78
Deleting a File	80
Printing Out a File	81
Adding Documents into a File	82
Retry an Incomplete File	83
Fax Access Code	84
Setting the Fax Access Code	84
Operating Your Machine with the Fax Access Code (Restrict all operations)	85
Operating Your Machine with the Fax Access Code (Restrict access of Fax Parameters only) [For UF-770 only]	85
Receive To Memory	86
Setting the RCV To Memory Password	86
Setting RCV To Memory	86
Printing Out Documents	87
Distinctive Ring Detector (DRD)	88
Fax Cover Sheet	89
General Description	89
To use the Fax Cover Sheet	89
Fax Cover Sheet	90
OMR Transmission	91
General Description	91
Sending Documents with your OMR Sheet	92
Fax Forward [For UF-770 only]	93
Setting Fax Forward	93
File Transmission [For UF-770 only]	94
Storing a Document(s)	94
Sending the Stored Document(s)	95
Deleting the Stored Document(s)	96
Printing the Stored Document(s)	97
Department Code [For UF-770 only]	98
General Description	98
Setting the Department Code	98
Changing or Erasing the Department Code	100
Sending Document with Department Code	102
Sending Document with Department Code (Voice Mode Transmission)	103
Printing a Department Code List	104
Printing a Department Code Journal	105
Multiple LOGO [For UF-770 only]	107
General Description	107
Setting the Multiple LOGO	107
Changing or Erasing the Multiple LOGO	108
Sending Document with Multiple LOGO	109
Printing a Multiple Logo List	110

6 NETWORKED FEATURES

Selective Reception	111
Setting the Selective Reception	111
Password Communications	112
General Description	112
Compatibility with Other Machines	112
Setting Password Transmission	113
Setting Password Reception	114
Using Password Transmission	115
Using Password Reception	116
Confidential Mailbox and Confidential Network Communications	117
Confidential Mailbox	117
Compatibility with Other Machines	117
Sending a Confidential Document to a Remote Station's Mailbox	118
Polling a Confidential Document from a Remote Station's Mailbox	119
Receiving a Confidential Document to Your Machine's Mailbox	120
Storing a Confidential Document in Your Machine's Mailbox	121
Printing Out a Confidential Document from Your Machine's Mailbox	122
Deleting a Confidential Document Stored in Your Machine's Mailbox	123
Confidential Network Communications (Via a Center Station)	124
Compatibility with Other Machines	125
Setting Up Your Machine for Confidential Network Communications	125
Relayed Transmission	128
General Description	128
Compatibility with Other Machines	128
Relay Network	129
Setting Up Your Machine for Relayed Transmission	131
Sending a Document by Relayed Transmission	135
Printouts and Reports	136
Sub-addressing	138
General Description	138
To set the Sub-address into a One-Touch/ABBR. Dialling Numbers	139
To send a Document with Sub-address	140

7 PRINTOUT JOURNALS AND LISTS

Journals and Lists	141
Transaction Journal	141
Individual Transmission Journal (IND. XMT JOURNAL)	142
Communication Journal (COMM. JOURNAL)	145
One-Touch/Abbreviated and Directory Search List	147
Program List	150
FAX Parameter List	151
Power Failure Report	152

8 PROBLEM SOLVING

Troubleshooting	153
If You Have Any of These Problems	153
Information Codes	155
Clearing a Recording Paper Jam	158
Clearing a Document Jam	159
Cleaning the Document Scanning Area	160
Cleaning the Printer Roller	161
Adjusting the Automatic Document Feeder (ADF)	162
Verification Stamp	163
Checking the Telephone Line	164

9 APPENDIX

Specifications	165
Recording Paper Specifications	168
Options and Supplies	169
Installing Memory Card	171
Glossary	172
INDEX	177

This page is intentionally left blank.



Thank you very much for purchasing the Panafax **UF-550/560/770**.

The **UF-550/560/770** is one of the most advanced models in the Panafax family of G3 compatible, desktop facsimile machines.

Some of its many features are

- 1. Plain Paper Printing** Plain paper printing means you can easily write on received documents with a pen or pencil. Documents do not curl, making filing easier. In addition, plain paper does not fade, making it ideal for long term storage of important documents.
- 2. Quick Scanning** The **UF-550/560/770** Quick Scan speeds up the fax process by scanning and storing documents into memory in about 2.8 seconds* per page.
(UF-550/560 : 6 seconds)*
This means that you no longer have to wait around until a transmission is completed before retrieving your documents.
- 3. Easy Maintenance** Maintenance requires only changing a toner cartridge, making it quicker and easier than with other types of plain paper fax machines.
- 4. Memory Function** A standard image memory feature allows you to store up to standard 70* pages into the document memory. After the **UF-550/560/770** stores your documents, it can send them to selected station(s) automatically. You do not have to wait until the transmission ends before retrieving your originals. *(* UF-550/560 : 12 standard pages)*
- 5. Dual Access Operation** The **UF-550/560/770** can reserve the next transmission even during reception or memory transmission. It can also receive during document storage.
- 6. Multiple LOGO** The **UF-770** can select from Multiple LOGOs which are printed on the Header of each page sent, Cover Sheet, COMM. Journal and Individual XMT Journal.
- 7. Department Code** This feature allows multiple departments to share the same facsimile machine. When a department code is assigned to each department, the Transaction Journal will be sorted by each department number.
- 8. View Mode** Your machine has been equipped with a View function which allows you to view the contents of the Journal and File List on the LCD display without having to print them.

With a little practice, anyone can learn how to use the most popular features of the **UF-550/560/770**.

This User's Guide will help you to use your **UF-550/560/770** quickly and easily. The Table of Contents shows where to find information on each feature. Although we recommend that you review each section briefly, it will only be necessary to read the sections that contain the feature(s) you will be using.

Function Key

Any function can be started by first pressing **FUNCTION** and then enter the function number, or by pressing **▼** or **▲** scroll key repeatedly until the desired function appears on the display.

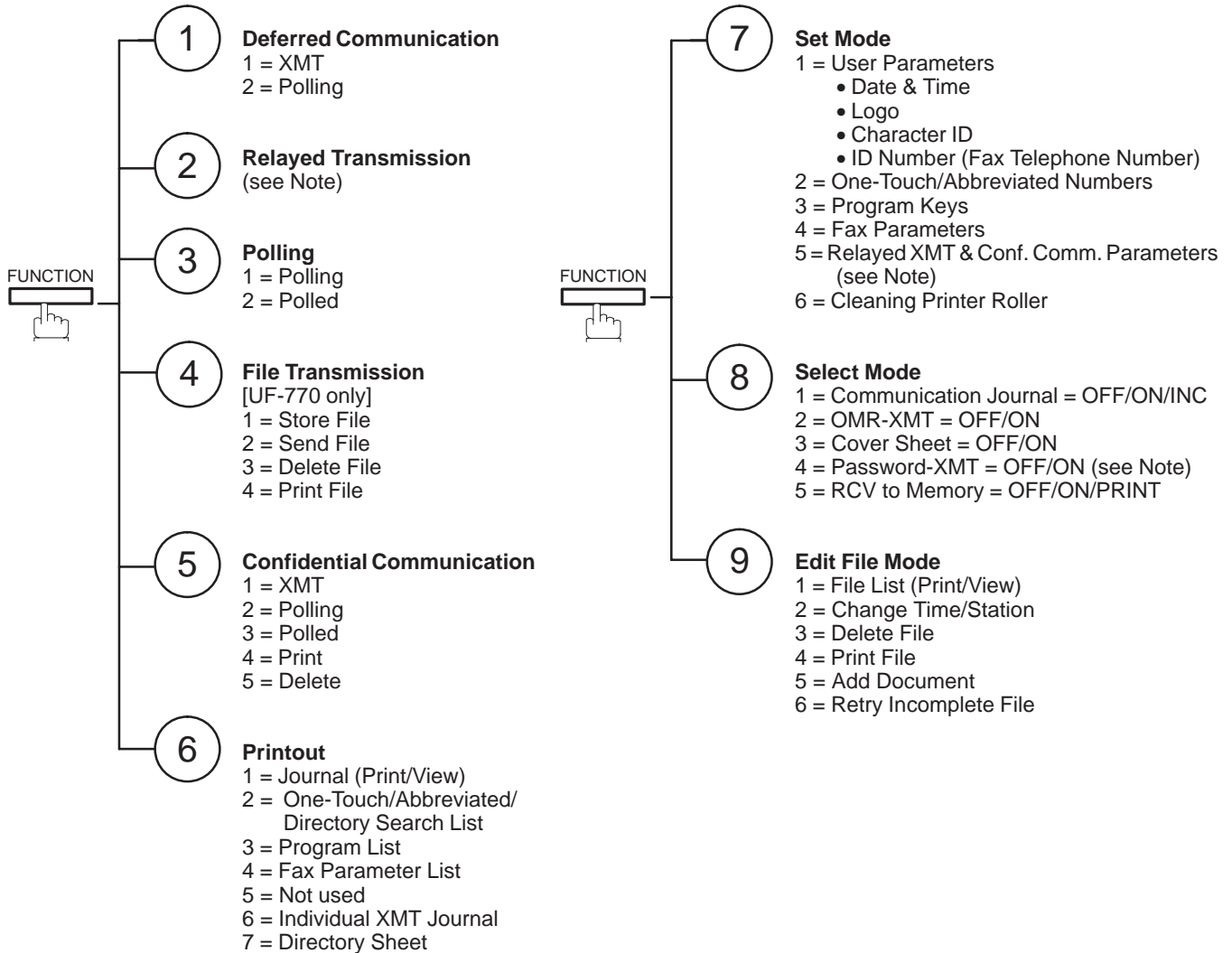

! **Note:** If Fax Parameter is not preset to Valid position, which enables you to use the function, the display will not show the function.

External View

1

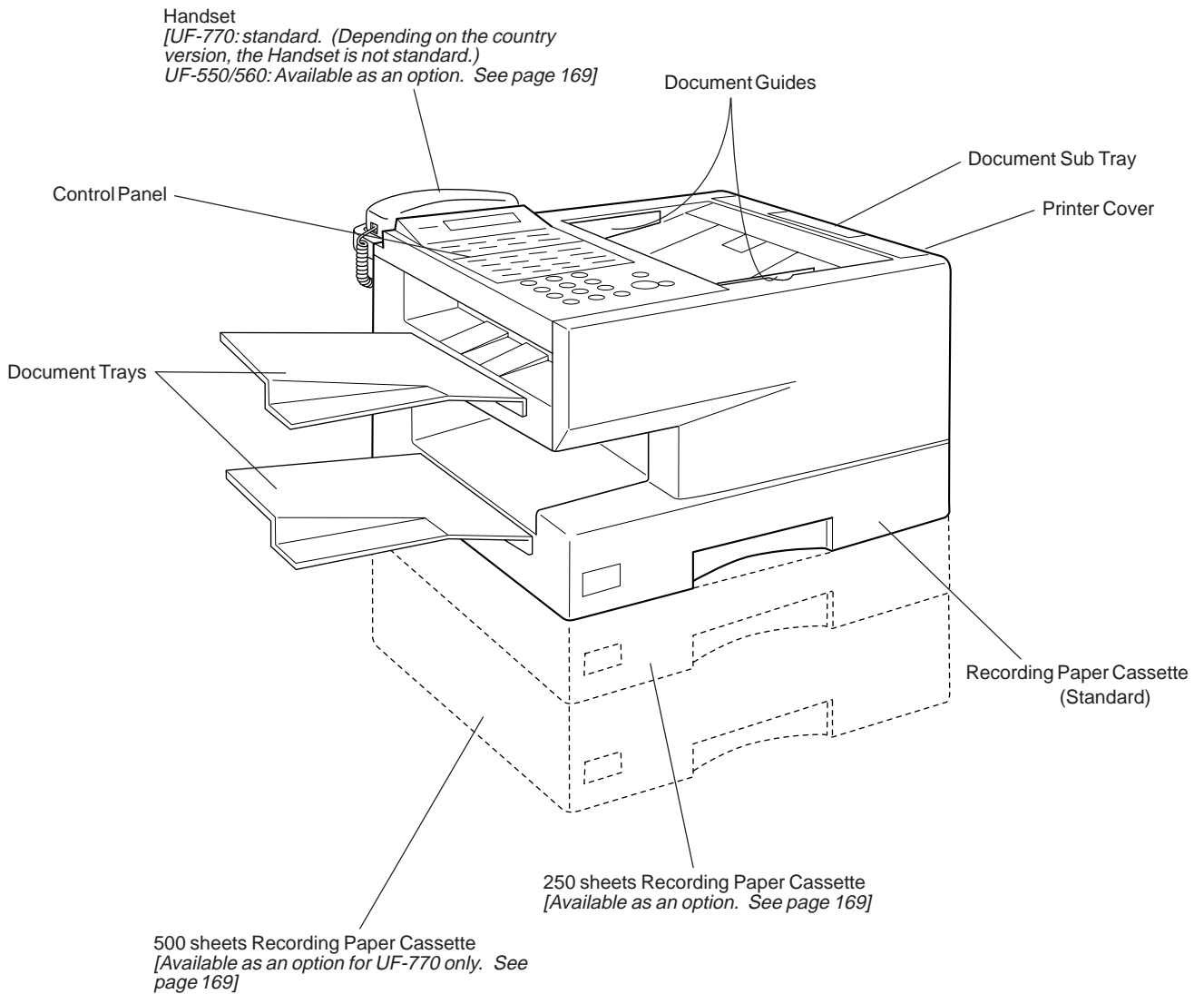

! **Note:** For some countries, the handset may not be available because of the country's regulation or specification.

Control Panel

LCD Display

Indicates date and time, or the current operation.

- ON LINE Blinks when the machine is transmitting a document or receiving.
- TONER Blinks when the toner has run out. (see page 16)
- ALARM Blinks when trouble occurs. (see page 158)

One-Touch Keys (01-32*)

Used for One-Touch Dialling.
(*UF-550/560: 01-24, see page 47 and 52)

Program Keys (P1-P8*)

Used to record long dialling procedures or Group Dialling Number keys.
(*UF-550/560: P1-P4, see page 70 to 75)

Character Keys

The One-Touch Keys and Program Keys also serve as character and symbol input keys which are used to record your LOGO and station name. The character key template is printed on the panel under the directory sheet cover.

Directory Sheet Overlay

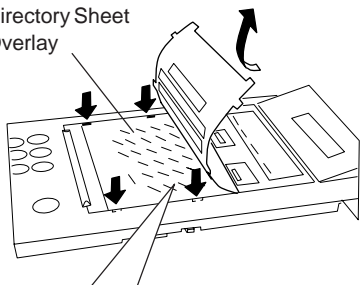

01	a	A	02	b	B	03	c	C	04	d	D	05	e	E	06	f	F	
07	g	G	08	h	H	09	i	I	10	j	J	11	k	K	12	l	L	
13	m	M	14	n	N	15	o	O	16	p	P	17	q	Q	18	r	R	
19	s	S	20	t	T	21	u	U	22	v	V	23	w	W	24	x	X	
25	y	Y	26	z	Z	27	ä	Ä	28	å	Å	29	ö	Ö	30	ü	Ü	
31	+	-	32	&	33	é	34	è	35	ê	36	ë	37	ç	38	ç	39	>
P5		AE	P6		:	P7		SPACE	P8		UPPER	LOWER						

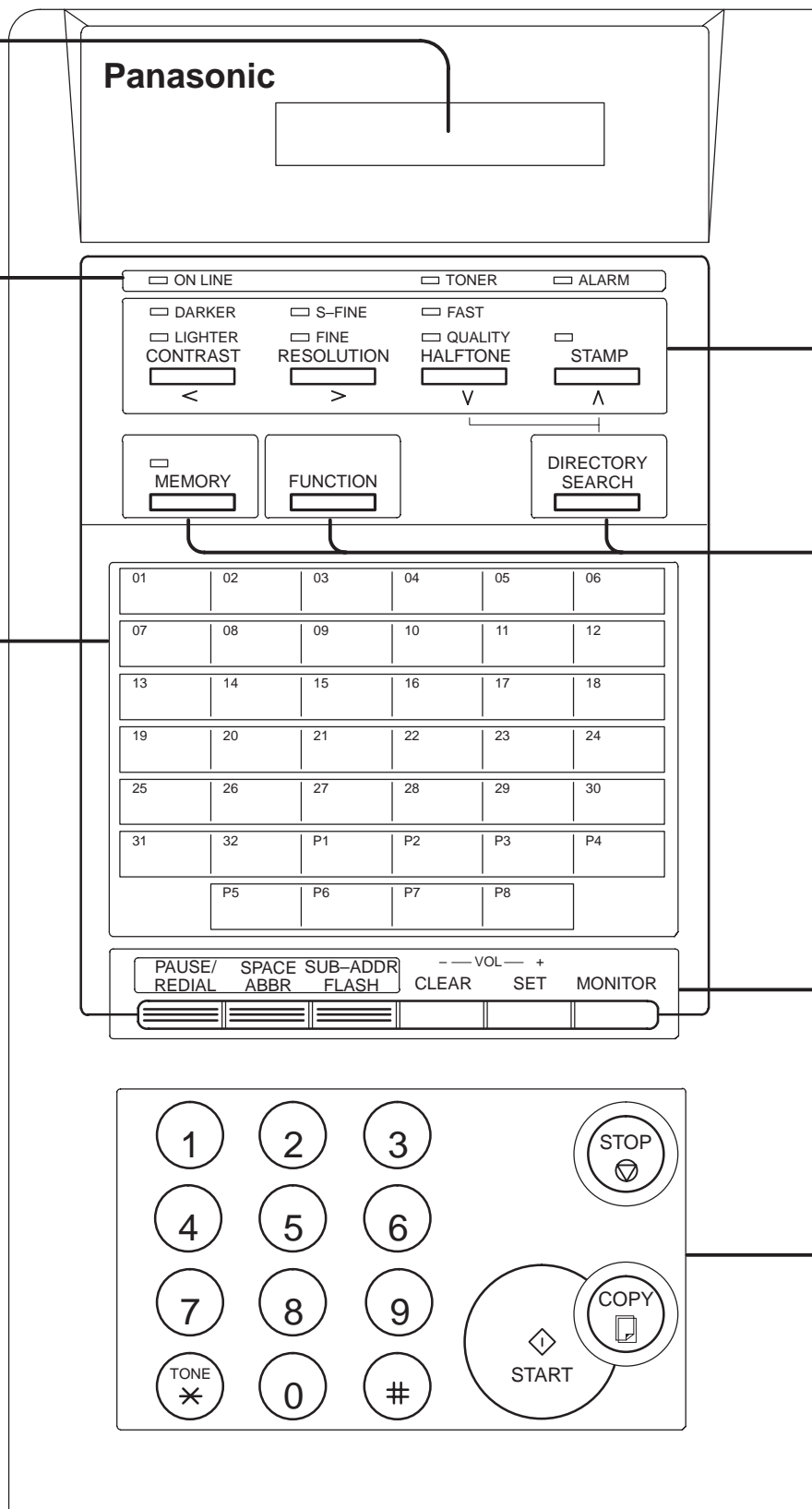

Note: Whenever One-Touch keys are changed to the character key mode (to record your LOGO and station names), use the **UPPER/LOWER** key to switch between upper and lower character set.





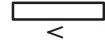
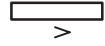
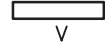
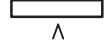



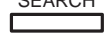

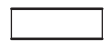

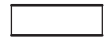
Control Panel

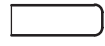
1

<p>CONTRAST</p> 	<p>Used to set Normal, Lighter, or Darker. (see page 41) Also serves as an arrow key (<) to move the cursor over recorded numbers and characters.</p>	<p>RESOLUTION</p> 	<p>Used to set Standard, Fine, Super-Fine. (see page 41) Also serves as an arrow key (>) to move the cursor over recorded numbers and characters.</p>
<p>HALFTONE</p> 	<p>Provides OFF, QUALITY or FAST settings for halftone documents. (see page 42) Also used for the following</p> <ul style="list-style-type: none"> • Search station name for Directory Search Dialling • Confirm entered station for multi-station communication. • Select functions. 	<p>STAMP</p> 	<p>Used to turn the verification stamp ON or OFF. (see page 42) Also used for the following</p> <ul style="list-style-type: none"> • Search station name for Directory Search Dialling • Confirm entered station for multi-station communication. • Select functions.

<p>MEMORY</p> 	<p>Used to select either memory or direct communication. (see page 44 to 54)</p>	<p>FUNCTION</p> 	<p>Used to start or select the function and sub-functions. These functions are explained in detail on the next page.</p>
		<p>DIRECTORY SEARCH</p> 	<p>Used to search for a station name (see page 49 and 54)</p>

<p>PAUSE/REDIAL</p> 	<p>Used to enter a pause when recording or dialling a telephone number, or to redial the last dialed number. (see page 59)</p>	<p>— — VOL CLEAR</p> 	<p>Used to erase the previously entered input. Also used to adjust the monitor and ringer volume. (see page 24)</p>
<p>SPACE ABBR</p> 	<p>Used to start Abbreviated Dialling. (see page 48 and 53)</p>	<p>VOL — + SET</p> 	<p>Used to set operations. Also used to adjust the monitor and ringer volume. (see page 24)</p>
<p>SUB-ADDR FLASH</p> 	<p>Used to access some features of your PBX.</p>	<p>MONITOR</p> 	<p>Used to start On-Hook Dialling or to make voice contact request. (see page 56)</p>

	<p>Used for Manual Number Dialling, recording phone numbers, and selecting functions.</p>		<p>Used to cancel operations. When it is pressed, the machine will return to standby.</p>
	<p>Used to temporarily change Dialling Mode to Tone when Pulse mode is set.</p>		<p>Used to make copies. (see page 64)</p>
	<p>Used to confirm current communication modes (e.g. Page number, ID, Dialed Telephone number, File number) when unit is ON LINE.</p>		<p>Used to start operations.</p>

Safety Information

This product complies with the requirements of EC Council Directives 73/23/EEC amended by 93/68/EEC, and 89/336/EEC amended by 92/31/EEC and 93/68/EEC.

⚠ WARNING denotes a potential hazard that could result in serious injury or death.

- TO PREVENT FIRE OR SHOCK, DO NOT EXPOSE THIS PRODUCT TO RAIN OR ANY TYPE OF MOISTURE.
- TO MINIMIZE THE POSSIBILITY OF SHOCK OR DAMAGE TO THE MACHINE, IT MUST BE PROPERLY GROUNDED.
- THIS PRODUCT CONTAINS HAZARDOUS RADIATION. IF YOU DO NOT FOLLOW THESE INSTRUCTIONS OR USE CONTROLS, MAKE ADJUSTMENTS OR PROCEDURES OTHER THAN THOSE SPECIFIED HEREIN, YOU MAY EXPOSE YOURSELF TO HAZARDOUS RADIATION.
- WHEN YOU OPERATE THIS EQUIPMENT, THE SOCKET-OUTLET SHOULD BE NEAR THE EQUIPMENT AND BE EASILY ACCESSIBLE.
- MAKE SURE THAT THE MACHINE IS INSTALLED IN A SPACIOUS OR WELL-VENTILATED ROOM SO AS NOT TO INCREASE THE AMOUNT OF OZONE IN THE AIR. SINCE OZONE IS HEAVIER THAN AIR, IT IS RECOMMENDED THAT AIR AT FLOOR LEVEL BE VENTILATED.
- PLUG POWER SUPPLY CORD INTO ORDINARY AC OUTLET BEFORE CONNECTING TELEPHONE LINE CORD. DISCONNECT TELEPHONE LINE CORD BEFORE UNPLUGGING POWER SUPPLY CORD FROM AC OUTLET.
- DISCONNECT THE EQUIPMENT IMMEDIATELY SHOULD IT EVER SUFFER PHYSICAL DAMAGE WHICH RESULTS IN THE INTERNAL PARTS BECOMING ACCESSIBLE IN NORMAL USE. IN THIS INSTANCE USERS SHOULD HAVE THE EQUIPMENT REPAIRED OR DISPOSE OF.
- IF THE POWER SUPPLY CORD AND/OR TELEPHONE LINE CORD OF THIS EQUIPMENT ARE DAMAGED, THEY MUST BE REPLACED BY THE SPECIAL CORDS SUPPLIED BY AN AUTHORIZED PANASONIC SERVICE CENTRE.

⚠ CAUTION

- 1 When you know that a thunderstorm is coming, we recommend that you:
 - (1) Unplug the telephone line cord from the phone jack.
 - (2) Turn off the power and unplug the power supply cord from AC outlet.
- 2 This equipment may not necessarily provide for the effective hand-over of a call to or from a telephone connected to the same line.
- 3 The operation of this equipment on the same line as telephones or other equipment with audible warning devices or automatic ring detectors will give rise to bell tinkle or noise and may cause false tripping of the ring detector. Should such problem occur, the user is not to contact telecom (telephone company) faults service.

WARNING NOTICE: No emergency call such as "111" or other call can be made from this device during a mains power failure.
This equipment shall not be set up to make automatic calls to the Telecom "111" Emergency Service.

CAUTION

denotes hazards that could result in minor injury or damage to the machine.

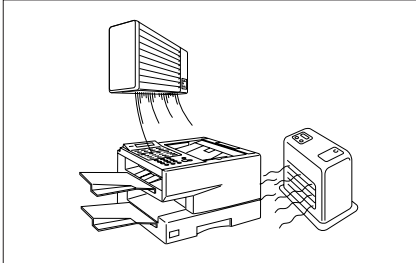

Do not install the machine near heating or air conditioning unit.

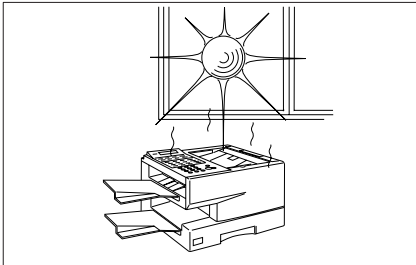

Avoid exposure to direct sunlight.

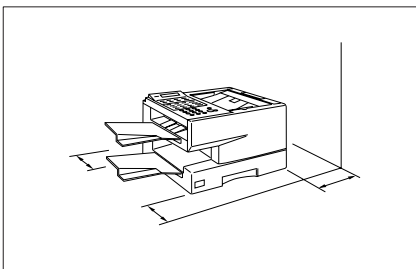

Install the machine on a flat surface, leave at least 10 cm of space between the machine and other objects.

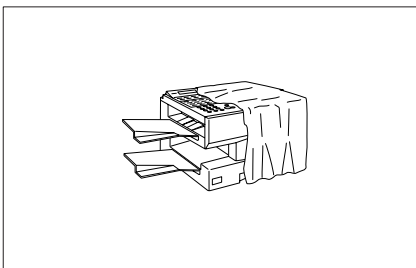

Do not block the ventilation openings.

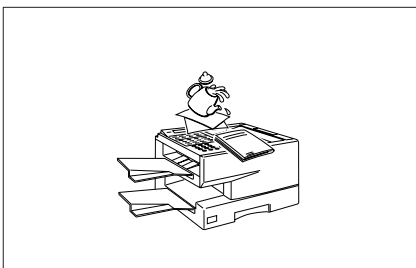

Do not place heavy objects, or spill liquids on the machine.

0000 Main Unit and Accessories

Unpack the carton and check that you have all the accessories illustrated.

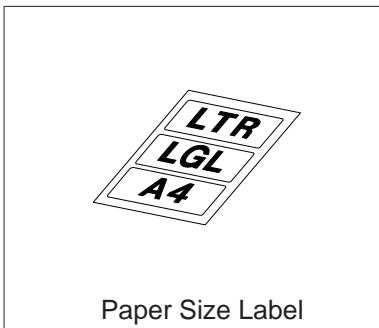
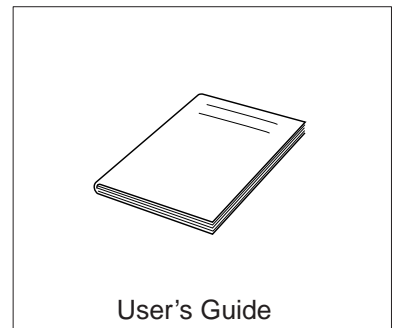
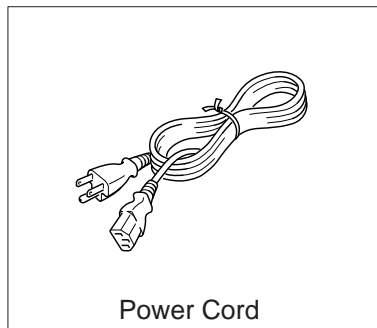
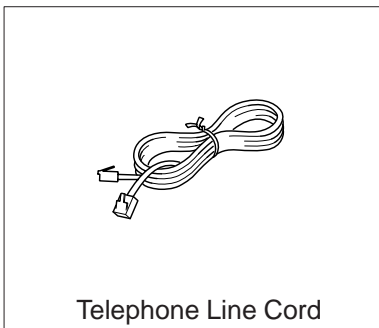
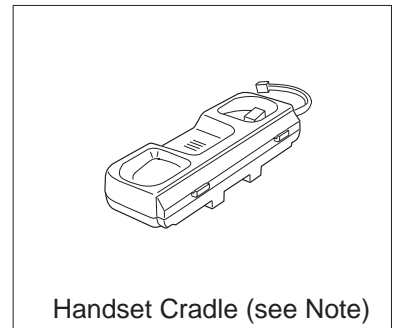
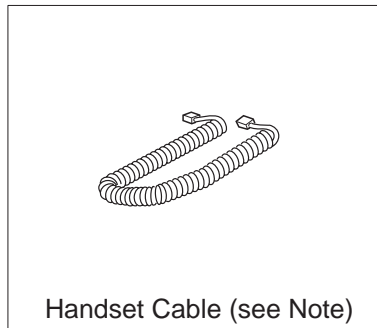
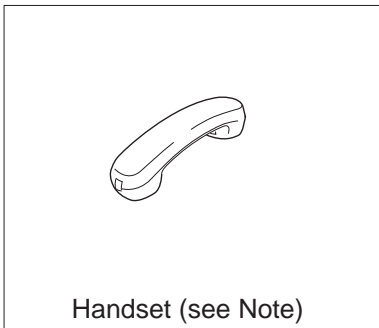
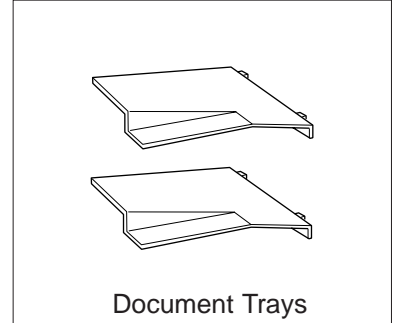
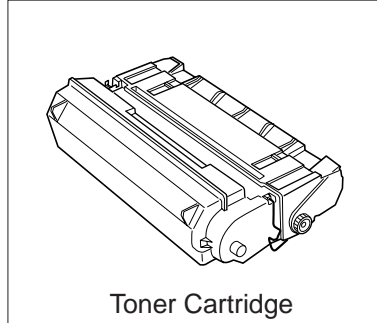
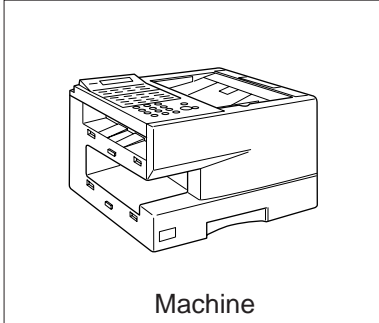

! **Note:** Available as an option for the UF-550/560. See page 169 for the order number.

Installing the Accessories ◀

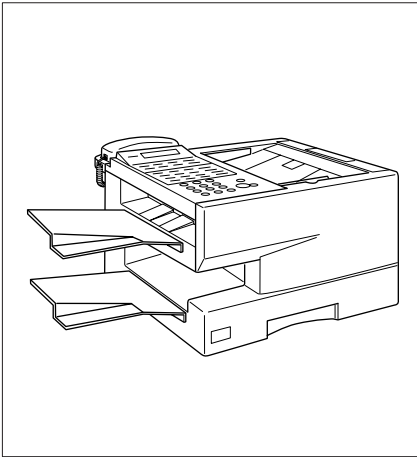

Final Installed View

Handset Cradle [Available as an Option (UF-550/560)]
Hook the projections into the square holes on the machine.
Connect the cable into the HANDSET jack on the machine.

Handset
[Available as an Option (UF-550/560)]

Document Trays
Hook the projections into the square holes on the machine.

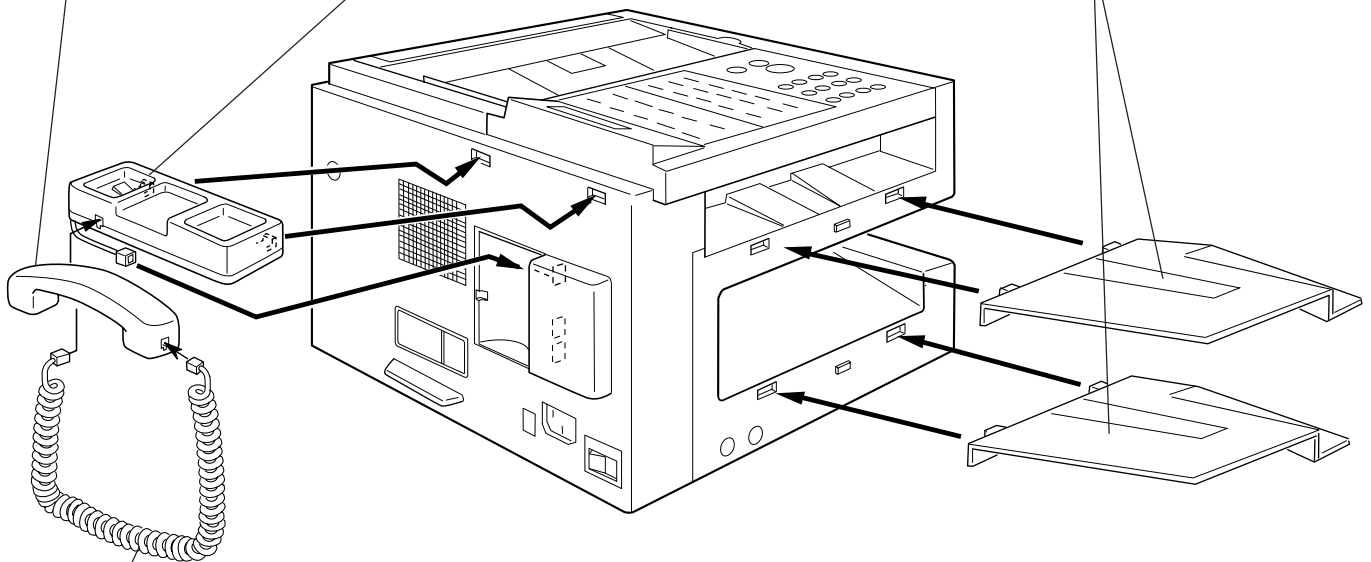

Handset Cable
[Available as an Option (UF-550/560)]



Note: For some countries, the handset may not be available because of the country's regulation or specification.

▶ Installing the Toner Cartridge

1

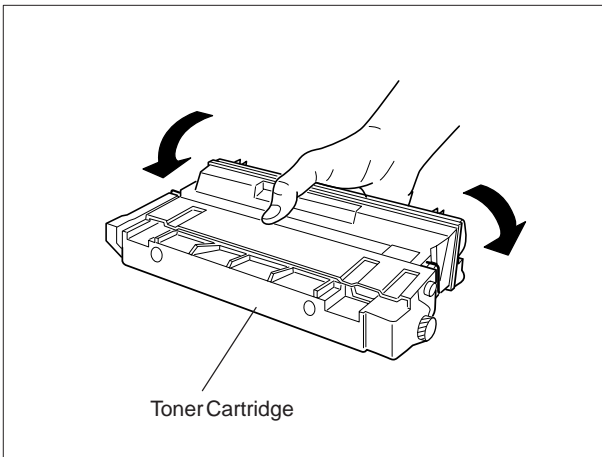

Unpack the Toner Cartridge and rock it back and forth as shown for 5 or 6 times to even the toner inside.

2

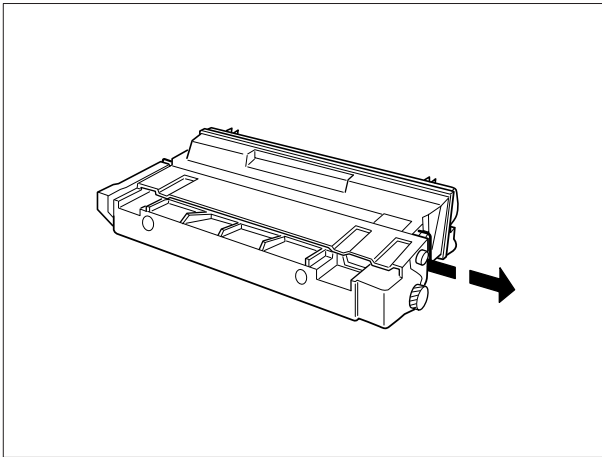

Remove the protective seal.

3

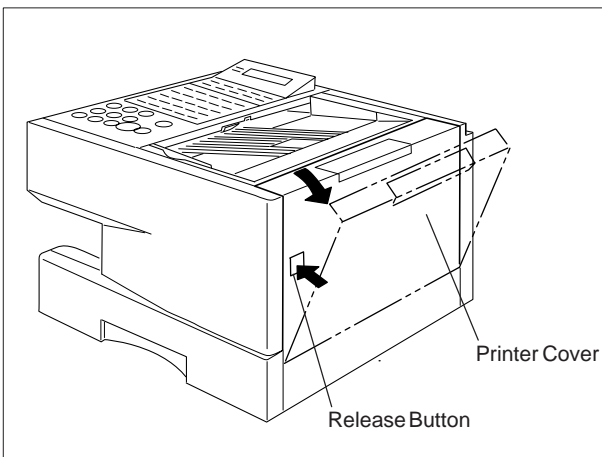

Push the Release Button to open the Printer Cover.

Continued on the next page.

Installing the Toner Cartridge

4

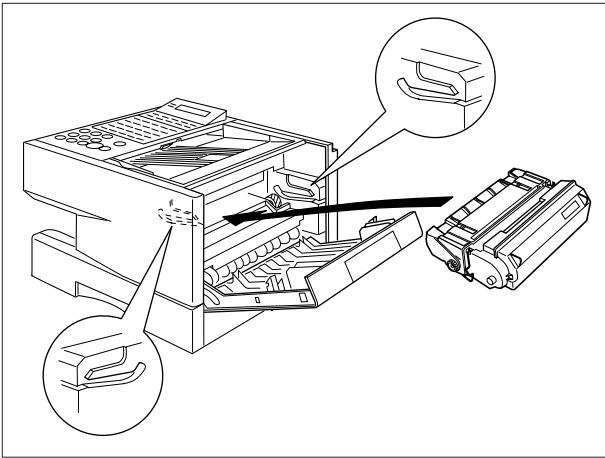

Align the arrow and the projection on both sides as shown and insert the Toner Cartridge into the machine.

5

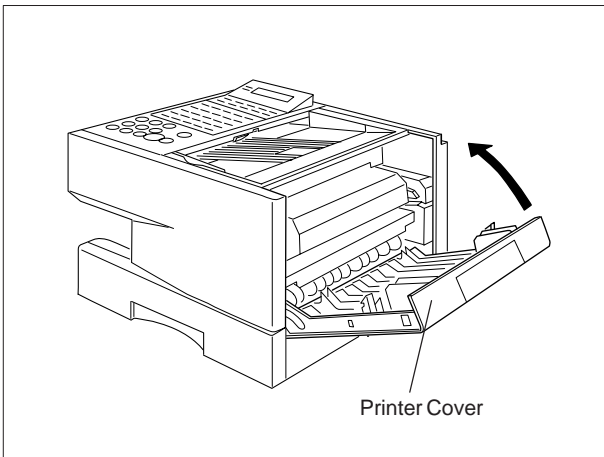

Close the Printer Cover firmly.

6

If you are replacing the Toner Cartridge, it is recommended to clean the Printer Roller to maintain good printing quality. To clean the Printer Roller, follow the procedure on page 161.

2

Loading the Recording Paper

Paper Specifications

In general, most bond papers will produce excellent results. Most photocopy papers will also work very well. There are many "name" and "generic" brands of paper available. We recommend that you test various papers until you obtain the results you are looking for. For detailed recommended paper specifications, see page 168.

How to Load the Recording Paper

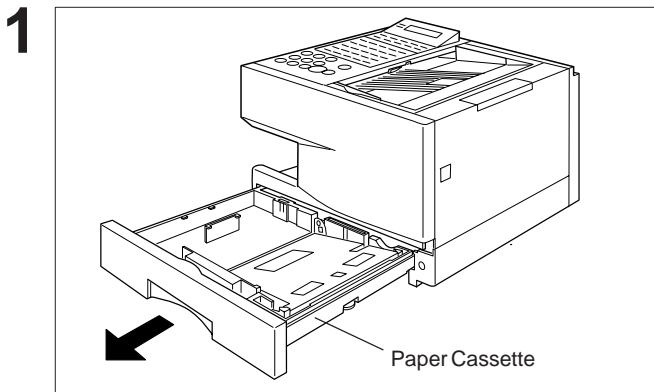

Slide out the Paper Cassette from the machine.

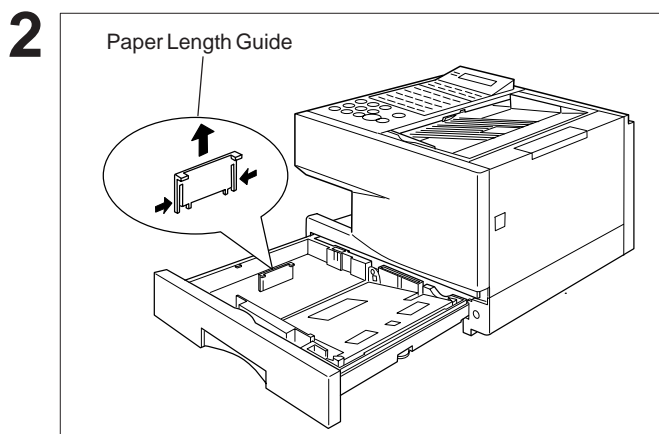

Adjust the Paper Length Guide to the proper paper size (A4, LTR, or LGL).

For LGL size paper, remove the Paper Length Guide and store it in the provided slot in the front left side of the Paper Cassette.

If reloading the same size of paper, skip the step 2 and 3.

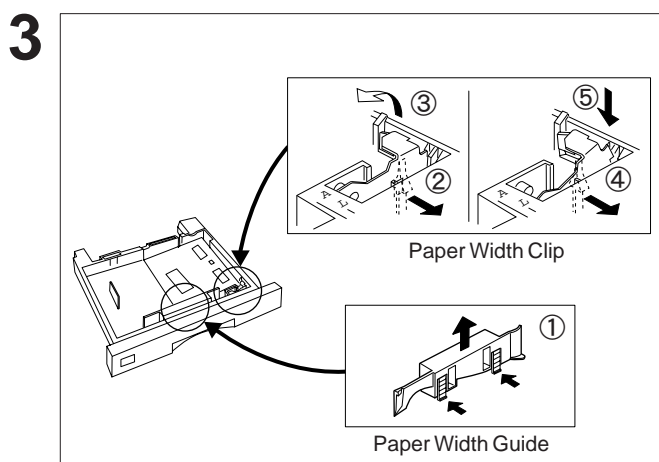

Adjust the Paper Width Guide and Clip to the proper paper (A4, or LTR/LGL).

The factory default for the Paper Width Guide and Clip are on A4 position. For LTR/LGL paper size, adjust by following the steps below.

- ① Replace the Paper Width Guide into the proper slot (A4 or LTR/LGL).
- ② Release the Paper Width Clip latch.
- ③ Pull upwards to remove the Paper Width Clip.
- ④ Replace the Paper Width Clip into the A(A4) or L(LTR/LGL) slot.
- ⑤ Push down on the Paper Width Clip to latch it in place.

Loading the Recording Paper

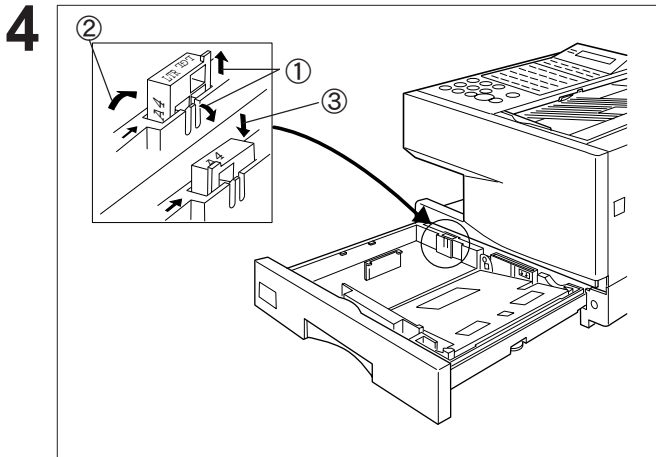

- ① Release the hook and remove the Paper Size Selector.
- ② Rotate the Paper Size Selector until the appropriate setting marked on the Selector is facing upward and the wording is upright.
- ③ Reinstall the Paper Size Selector.

[For UF-550/560]

There is no paper size selector on the paper cassette. Refer to page 22 for the Recording Paper Size Setting.

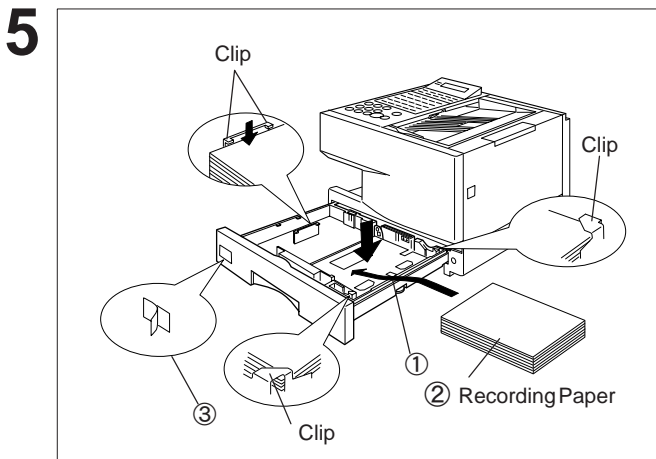

- ① Push the Pressure Plate until it is locked down.
- ② Load the paper into the Paper Cassette.

Caution: Make sure that the paper is set under the clips of the Paper Cassette. You can load about 250 sheets with standard weight paper (20 lb. or 75 g/m²). For paper specification see page 168.

- ③ Set the proper paper size label.

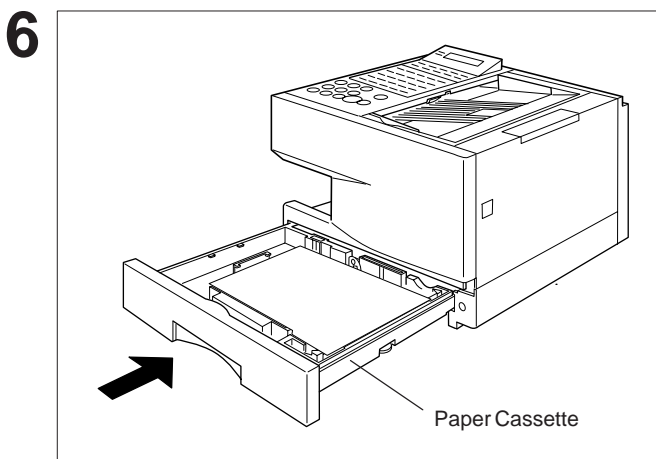

Slide the Paper Cassette into the machine.



Note: 1. The Recording Paper Size setting must match the paper loaded in the cassette. See page 22.
2. Your machine will properly print on A4, Letter and Legal size paper only. If other size of paper (B4, B5, A5) is used, your machine may not print properly.

Connecting the Telephone Line Cord and Power Cord

■ Telephone Line Cord

Plug one end of the telephone line cord into the telephone jack supplied by the telephone company and the other end into the LINE jack on the rear of the machine.

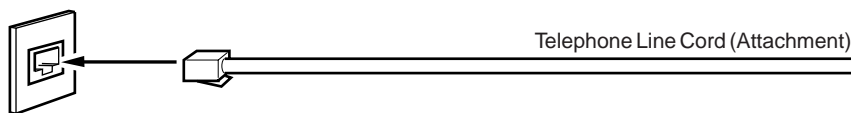

■ Power Cord

Plug one end of the power cord into an ordinary AC outlet and the other end into the receptacle on the rear of the machine.

Warning : This apparatus must be properly grounded through an ordinary AC outlet.

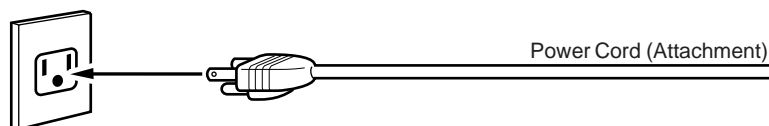

- Note:**
1. Your machine uses little power and you should keep it ON at all times. If the power is turned OFF for too long, the contents of the memory may be lost.
 2. UF-770 has 2 separate rechargeable batteries to preserve the memory contents in case of a short term power failure. One for the machine parameters (such as LOGO, ID Number, Auto-dialer Telephone Number, etc.) which can back up for 10 days and the other one for the document memory, which can back up for 1 hour when fully charged.
UF-550/560 has a rechargeable battery to preserve the machine parameters only for up to 10 days when fully charged.
 3. The built-in rechargeable batteries require 48 hours to be fully charged in the machine.

Connecting the Telephone Line Cord and Power Cord

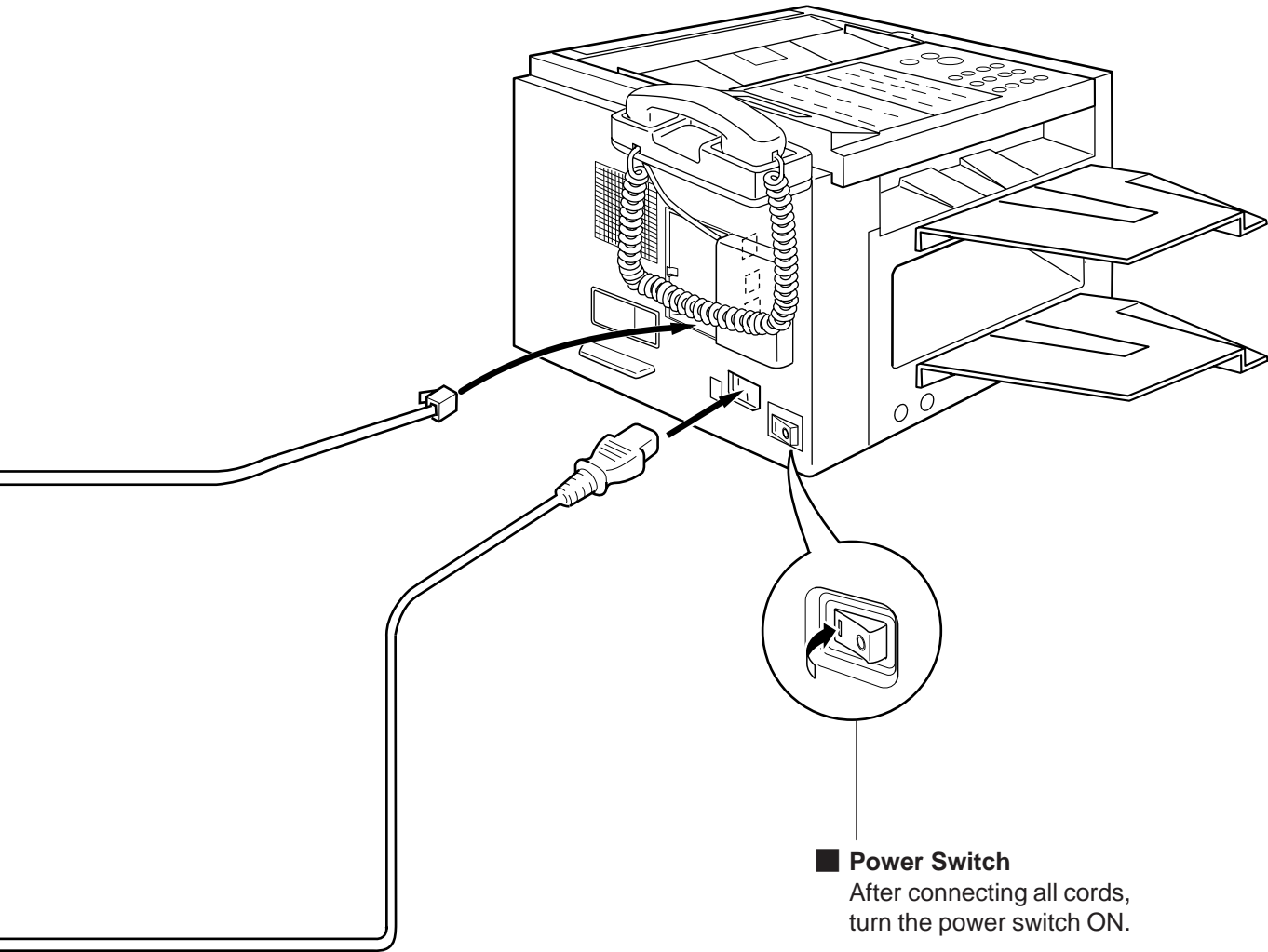

■ **Power Switch**
After connecting all cords,
turn the power switch ON.

Setting the Recording Paper Size [For UF-550/560 only]

The Recording Paper Size setting must match the paper loaded in the cassette. If you change the Recording Paper Size, please change the setting by following the procedure below.

1



SET MODE (1-6)
 ENTER NO. OR V ^

2



FAX PARAMETER(01-99)
 NO. = █

3





23 REC. PAPER SIZE
 1:A4

4



for A4 size paper.

or



for Letter size paper.

23 REC. PAPER SIZE
 2:LETTER

or



for Legal size paper.

23 REC. PAPER SIZE
 3:LEGAL

5

Setting the Dialling Method (Tone or Pulse) ◀

Your machine can operate with either of two dialling methods (Tone or Pulse), depending on the type of telephone line you are connected to. If you need to change the dialling method to Tone or Pulse, follow the procedure below.

1

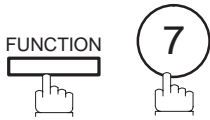

SET MODE (1-6)
ENTER NO. OR V ^

2



FAX PARAMETER(01-99)
NO. = █

3

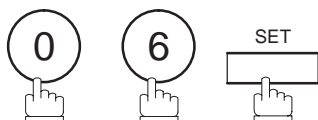

06 DIALLING METHOD
2:TONE

4

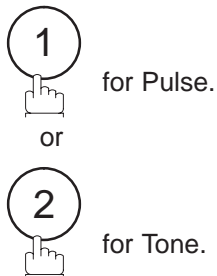

06 DIALLING METHOD
1:PULSE

or

06 DIALLING METHOD
2:TONE

5

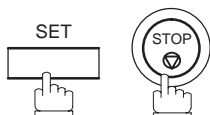

2

▶ Adjusting the Volume

You can adjust the monitor and ringer volume on your machine. The built-in speaker enables you to hear the dial tone, dialling signals, and busy tone. The ringer sounds when your machine receives a call.

Setting the Monitor Volume

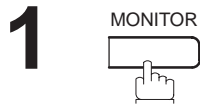

You will hear the dial tone through the speaker.

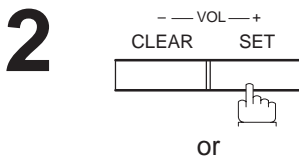

repeatedly to raise the volume.



or

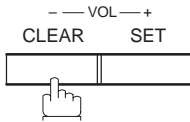

repeatedly to lower the volume.

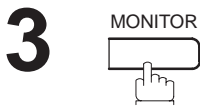
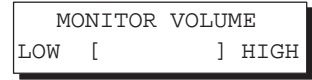

Setting the Ringer Volume

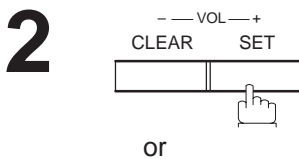
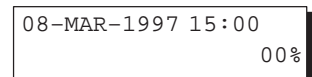
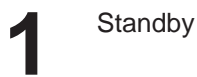

repeatedly to raise the volume.

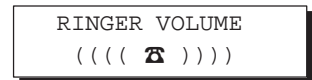

or

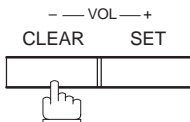

repeatedly to lower the volume.



! **Note:** You can also adjust the volume of the key touch tone and the volume of the buzzer in Fax Parameter No. 10 (KEY/BUZZER VOLUME). (see page 35)

Your facsimile machine has several basic settings (User Parameters) to help you keep records of the documents you send or receive. For example, the built-in clock keeps the current date and time, and your LOGO and ID Number help to identify you when you send or receive documents.

If a power failure occurs, a built-in battery will back up this information for up to 10 days when it is fully charged.

Setting the Date and Time











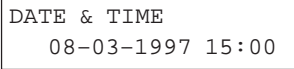

At standby the display will show the date and time. Once the standby display is set, it will automatically be updated.



1   



2  

3  

4 Enter the new date and time.

Ex:	 	Date	: 08th	
	 	Month	: March	
	   	Year	: 1997	
	   	Time	: 3:00 PM	

If you make a mistake, use  or  to move the cursor to the incorrect number and enter the new number over it.

5  

User Parameters

Setting Your LOGO

When you send a document, your LOGO appears on the top of the copy printed out at the other station. The LOGO helps to identify you to someone who receives your document.

1

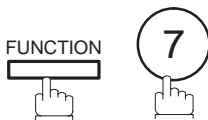

```
SET MODE      (1-6)
ENTER NO. OR V ^
```

2



```
1:USER PARAMETERS?
PRESS SET TO SELECT
```

3

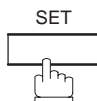

repeatedly until display shows;

```
LOGO
█
```

4

Enter your LOGO (max. 25 characters and digits) by using the Character keys (see page 10).

Ex: P A N A S O N I C

If you make a mistake, use < or > to move the cursor to the incorrect character and enter the new character over it. If more than 19 characters are entered, the left side characters will scroll off the display.

```
LOGO
PANASONIC █
```

5

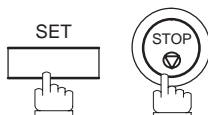

Setting Your Character ID

If the remote machine has a Character ID capabilities, when you are sending or receiving, your Character ID will appear on the remote machine's display and the remote machine's Character ID will appear on your display.

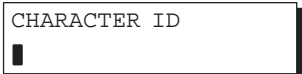

1   

2  



3  repeatedly until display shows; 

4 Enter your Character ID (max. 16 characters and digits) by using the Character keys (see page 10).

Ex: H E A D SPACE O F F I C E

If you make a mistake, use  or  to move the cursor to the incorrect character and enter the new character over it.



5  

 **Note:** The special characters of Å, Ä, Ö, Ü, Æ, è and é cannot be used for Character ID.

User Parameters



Setting Your ID Number (Fax Telephone Number)

If the remote machine does not have a Character ID but it has an ID Number, when sending or receiving, your ID Number will appear on the remote machine's display and their ID Number will appear on your display.

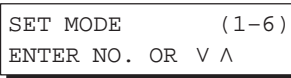
We suggest you use your facsimile telephone number as your ID number. (max. 20 digits)

1   

2  



3  repeatedly until display shows; 

4 Enter your ID (max. 20 digits) by using the key pad and **SPACE**.

Ex: **2 0 1 SPACE 5 5 5**
SPACE 1 2 1 2

Display showing: ID NO. 201 555 1212

If you make a mistake, press **CLEAR** to erase the number then reenter the correct number.

5  

! **Note:** 1. You may use ***** to enter a "+" character at the beginning of the ID number to indicate the following digit(s) for your country code.

Ex: +1 201 555 1212 +1 for U.S.A. country code.
+81 3 111 2345 +81 for Japan country code.

2. For some countries, this feature is not available depending on the country's regulation. The display may not show this feature.

One-Touch/Abbreviated Dialling Numbers

Entering One-Touch/Abbreviated Dialling Numbers

One-Touch and Abbreviated Dialling are two fast ways of dialling full telephone numbers. To use these dialling methods, you must first store the telephone number using the following procedure.

To enter a One-Touch key, follow these steps below

1   SET MODE (1-6)
ENTER NO. OR V ^

2   1: ONE-TOUCH
2: ABBR. NO.

3  ONE-TOUCH< >
PRESS ONE-TCH OR V ^

4 Ex: 01 <01>
ENTER TEL. NO.

5 Enter the telephone number.
(up to 36 digits including pauses and spaces)
Ex: 9 PAUSE 5 5 5 SPACE 1 2 3 4 <01>
9-555 1234

6  <01> ENTER NAME
9-555 1234

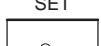

7 Enter the station name using character keys
(up to 15 characters).
Ex: S A L E S SPACE D E P T <01> SALES DEPT
9-555 1234



8  ONE-TOUCH< >
PRESS ONE-TCH OR V ^

To record another number, repeat step 4 to 8.
To return to standby, press STOP.

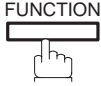
One-Touch/Abbreviated Dialling Numbers

To set an Abbreviated Dialling Number, follow these steps below

- 1**  

SET MODE (1-6)
ENTER NO. OR V ^
- 2**  

1: ONE-TOUCH
2: ABBR. NO.
- 3** 

ABBR. []
ENTER NO. OR V ^
- 4** Ex: ②② (UF-770: 00 to 99, UF-550/560: 01 to 72)

[22]
ENTER TEL. NO.
- 5** Enter the telephone number.
(up to 36 digits including pauses and spaces)
Ex: ⑨ [PAUSE] ⑤ ⑤ ⑤ [SPACE] ② ③ ④ ⑤

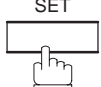
[22]
9-555 2345
- 6** 

[22] ENTER NAME
9-555 2345
- 7** Enter the station name using character keys
(up to 15 characters).
Ex: [A] [C] [C] [O] [U] [N] [T] [I] [N] [G]

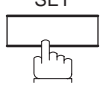
[22] ACCOUNTING
9-555 2345
- 8** 

ABBR. []
ENTER NO. OR V ^

To record another number, repeat step 4 to 8.
To return to standby, press [STOP] .

- !** **Note:**
1. If you require a special access number to get an outside line, enter it first and then press [PAUSE] .
A hyphen "-" is displayed for pause.
 2. Use [SPACE] to enter a space between the numbers to make it easier to read.
 3. The built-in battery can back up One-Touch/ABBR. Numbers up to 10 days when a power failure occurs.
 4. If you are using Pulse dialling and you wish to change to Tone dialling in the middle of dialling, press [TONE] (represented by a"/"). The dialling method will be changed from Pulse to Tone after dialling the digit "/".
Ex : 9 PAUSE TONE 5551234
 5. You can search for an unused One-Touch key or ABBR. number by pressing [v] or [^] in step 3 or 4.

One-Touch/Abbreviated Dialling Numbers

Changing or Erasing One-Touch/Abbreviated Dialling Numbers

If you have to change or erase any of the One-Touch/Abbreviated dialling numbers, follow the steps below.

To change the settings of a One-Touch/ABBR. dialling number

1

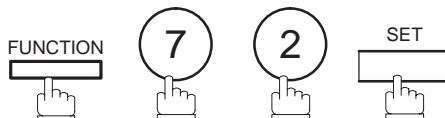

```
1: ONE-TOUCH
2: ABBR. NO.
```

2

Select 1 for One-Touch Dialling number
Select 2 for ABBR. Dialling Number

Ex: ①

3

Enter the station you wish to change

Ex: 01

```
ONE-TOUCH< >
PRESS ONE-TCH OR V ^
```

```
<01> SALES DEPT
9-555 1234
```

4

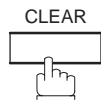

then enter a new telephone number. (see Note 1 and 2)

Ex: ⑨ PAUSE ⑤ ⑤ ⑤ SPACE ③ ④ ⑤ ⑥

```
<01> SALES DEPT
ENTER TEL. NO.
```

```
<01> SALES DEPT
9-555 3456
```

5

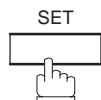

```
<01> SALES DEPT
9-555 3456
```

6

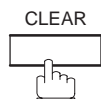

then enter a new station name. (see Note 1 and 3)

Ex: P A N A F A X

```
<01> ENTER NAME
9-555 3456
```

```
<01> PANAFAX
9-555 3456
```

7

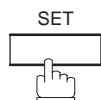

To return to standby, press STOP.

```
ONE-TOUCH< >
PRESS ONE-TCH OR V ^
```



- Note:**
- Use or to move the cursor, then enter the correct number over the incorrect number.
 - Use to insert a space between the numbers you set. If the telephone number is 36 digits in length, cannot be used to insert a space.
 - cannot be used to insert a space in setting of the station name.
 - If the One-Touch/Abbreviated dialling number has been used for a communication reservation, the settings cannot be changed or erased until the communication has finished.
To change or erase the settings, cancel the communication first by Edit File Mode (see page 76).

One-Touch/Abbreviated Dialling Numbers

To erase the settings of One-Touch/ABBR. Dialling number

1

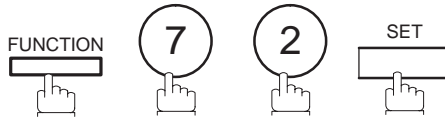

```
1:ONE-TOUCH  
2:ABBR. NO.
```

2

Select 1 for One-Touch Dialling number
Select 2 for ABBR. Dialling Number

Ex: ①

```
ONE-TOUCH< >  
PRESS ONE-TCH OR v ^
```

3

Enter the station you wish to erase

Ex:

```
<01> SALES DEPT  
9-555 1234
```

4

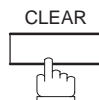

```
<01> PANAFAX  
ENTER TEL. NO.
```

5



```
ONE-TOUCH< >  
PRESS ONE-TCH OR v ^
```

To return to standby, press .

! **Note:** If the One-Touch/Abbreviated dialling number has been used for a communication reservation, the settings cannot be changed or erased until the communication has finished.
To change or erase the settings, cancel the communication first by Edit File Mode (see page 76).

One-Touch/Abbreviated Dialling Numbers

3

Printing Out a Directory Sheet

After programming a one-touch dialling number, you can print out the directory sheet which includes the first 12 characters of each station name. Cut along the dotted line and place it over the One-Touch key under the Directory Sheet Cover. To print out a directory sheet, follow the steps below.

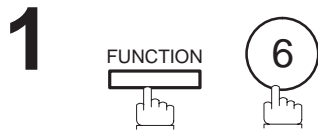

```
PRINT OUT      (1-7)
ENTER NO. OR V ^
```



```
* PRINTING *
DIRECTORY SHEET
```

Your machine prints out the directory sheet.

```
***** -DIRECTORY SHEET- ***** DATE 08-MAR-1997 ***** TIME 15:00 *****
```

01	02	03	04	05	06
SALES DEPT	ENG. DEPT	ACCT. DEPT	EXPORT DEPT	R & D DEPT	MARKET DEPT
07	08	09	10	11	12
13	14	15	16	17	18
19	20	21	22	23	24
25	26	27	28	29	30
31	32	P1	P2	P3	P4
	P5	P6	P7	P8	

 dotted line -PANASONIC -

```
***** -HEAD OFFICE -**** -201 555 1212- *****
```

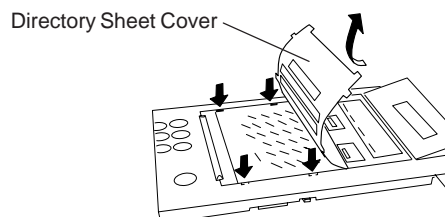

Customizing Your Machine

Your facsimile machine has a variety of adjustable Fax Parameters. These parameters, listed in the Parameter Table, are preset for you and do not need to be changed. If you do want to make a change, read the table carefully. Some parameters, such as the Resolution, Contrast, and Verification Stamp parameters, can be temporarily changed by simple key operation just before a transmission is made. When the transmission ends, however, these parameters return to their preset values (Home position). Other parameters can only be changed by the procedure described below.

Setting the Fax Parameters

1

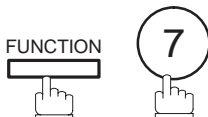

```
SET MODE      (1-6)
ENTER NO. OR V ^
```

2

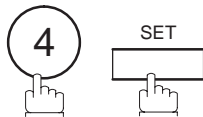

```
FAX PARAMETER(01-99)
NO. = █
```

3

Enter Fax Parameter number from the Parameter Table (see pages 35 to 38).

Ex: ① ① for **CONTRAST**

```
FAX PARAMETER(01-99)
NO. = 01
```

4



```
01 CONTRAST
1: NORMAL
```

5

Enter the new setting value.

Ex: ② for **LIGHTER**

```
01 CONTRAST
2: LIGHTER
```

6



```
02 RESOLUTION
1: STANDARD
```

To set another parameter, press **CLEAR** to return to step 3, or, to return to standby, press **STOP**.



Note: 1. To scroll the Fax Parameters in Step 2 or 4, press **▼** or **▲**.

2. To print out a Fax Parameter List, see page 151.

3. The built-in battery when fully charged can back up the Fax Parameter settings for up to 10 days when a power failure occurs.

Fax Parameter Table

No.	Parameter	Setting Number	Setting	Comments
01	CONTRAST	1	Normal	Setting the home position of the CONTRAST key.
		2	Lighter	
		3	Darker	
02	RESOLUTION	1	Standard	Setting the home position of the RESOLUTION key.
		2	Fine	
		3	S-Fine	
04	STAMP	1	Off	Setting the home position of the STAMP key. To select the stamp function when document is stored in memory (see Fax Parameter No. 28).
		2	On	
05	MEMORY	1	Off	Setting the home position of the MEMORY key.
		2	On	
06	DIALLING METHOD	1	Pulse	Selecting the dialling method.
		2	Tone	
07	HEADER PRINT	1	Inside	Selecting the printing position of the header. Inside : Inside TX copy area. Outside : Outside TX copy area. No print : Header is not printed.
		2	Outside	
		3	No print	
08	HEADER FORMAT	1	Logo, ID No.	Selecting the header format.
		2	From To	
09	RCV'D TIME PRINT	1	Invalid	Selecting whether or not the machine prints the received date & time, remote ID, percentage of reduction and page number on the bottom of each received page.
		2	Valid	
10	KEY/BUZZER VOLUME	1	Off	Selecting the volume of the Key/Buzzer tone.
		2	Soft	
		3	Loud	
12	COMM. JOURNAL	1	Off	Selecting the home position of printout mode for COMM. Journal Off/Always/Inc. only Off : No printout Always : Always prints out Inc. only : Printout when communication has failed.
		2	Always	
		3	Inc. only	
13	AUTO JOURNAL PRINT	1	Invalid	Selecting whether or not the machine prints the journal automatically after every 100* transactions. (*UF-550/560 : 32 transactions)
		2	Valid	
14	FILE ACCEPTANCE REPORT	1	Invalid	Selecting whether or not the machine prints the file acceptance journal. If you set this parameter to valid, the journal will be printed out after entering any communications using memory.
		2	Valid	

Continued on the next page.

Customizing Your Machine

No.	Parameter	Setting Number	Setting	Comments
17	RECEIVE MODE	1	Manual	Setting the reception mode either automatic or manual.
		2	Auto	
22	SUBSTITUTE RCV	1	Invalid	Selecting whether or not the machine receives to memory when recording paper runs out, toner runs out or recording paper jammed.
		2	Valid	
23	RECORDING PAPER SIZE	1	A4	Setting the recording paper size installed in your machine. (UF-550/560 only)
		2	Letter	
		3	Legal	
24	PRINT REDUCTION	1	Fixed	Selecting print reduction mode. Fixed: Reduce received document according to setting of Parameter No. 25.
		2	Auto	Auto: Reduce received document according to the length of received documents.
25	REDUCTION RATIO	70	70%	Selecting fixed print reduction ratio from 70% to 100%. This parameter functions only when fixed print reduction is selected on fax parameter no. 24.
		---	---	
		100	100%	
26	POLLING PASSWORD		(----	Setting a 4-digit password for secured polling.
27	POLLED FILE SAVE	1	Invalid	Selecting whether or not the machine retains the polled document in memory even after the document is polled once.
		2	Valid	
28	STAMP AT MEM. XMT	1	Invalid	Selecting whether or not the machine stamps the original documents when storing the documents into memory. (depending on the Stamp setting on the Control Panel.)
		2	Valid	
30	DRD SERVICE	1	Invalid	Selecting whether or not the machine is available "DRD Service". If this parameter is set to "Valid", your machine detects the specified ring pattern only to receive a document automatically.
		2	Valid	
31	INCOMPLETE FILE SAVE	1	Invalid	Selecting whether or not the machine retains the document in memory if the document is not successfully transmitted.
		2	Valid	
32	COPY REDUCTION	1	Invalid	Selecting whether or not the machine performs copy reduction in accordance with the setting of Parameter No. 24 and 25.
		2	Valid	
33	XMT REDUCTION	1	Invalid	Selecting whether or not the machine performs reduction when the transmitting document is wider than the recording paper used at the receiving machine. (UF-770 only)
		2	Valid	
34	POWER SAVE TIMER	--	Start-Time	To reduce the power consumption of the machine in standby, select the time period to turn off the high temperature fuser unit when the printer is idle. Factory default is always "ON" (When Start = 00:00 and End = 00:00).
		--	End-Time	

Continued on the next page.

Customizing Your Machine

No.	Parameter	Setting Number	Setting	Comments
37	RCV TO MEMORY		(----	Enter a 4-digit password used to print out the received document in memory by F8-5 (RCV TO MEMORY). When F8-5 is set to On, this parameter will not be shown on the LCD display. (see page 86)
38	FAX ACCESS CODE		(----	Enter a 4-digit Fax Access Code to secure the machine from unauthorized use. (see page 84)
40	RELAY XMT REQUEST	1	Invalid	Selecting whether or not the machine performs Relay XMT Request. (see page 128)
		2	Valid	
41	CONF. FAX PARAMETER	1	Invalid	Selecting whether or not the machine performs Confidential Network Communication. (see page 124)
		2	Valid	
42	CONF. POLLED FILE SAVE	1	Invalid	Selecting whether or not the machine saves the confidential polled file even after the file is polled once.
		2	Valid	
43	PASSWORD-XMT	1	Off	Setting a 4-digit XMT-Password and selecting whether or not the machine performs and checks the XMT-Password of the receiving station when transmitting. (see page 112)
		2	On	
44	PASSWORD-RCV	1	Off	Setting a 4-digit RCV-Password and selecting whether or not the machine performs and checks the RCV-Password of the transmitting station when receiving. (see page 112)
		2	On	
46	SELECT RCV	1	Invalid	Selecting whether or not the machine performs selective reception. (see page 111)
		2	Valid	
48	TELEPHONE LINE	1	PSTN	Selecting the type of line connected.
		2	PBX	
49	PSTN ACCESS CODE		0---	Setting PSTN Access Code. (max. 4 digits)
50	FLASH KEY	1	Earth	Selecting to use FLASH on control panel either as Earth key or Flash key.
		2	Flash	
52	DIAGNOSTIC PASSWORD		(----	Setting the password for Remote Diagnostic Mode. Please ask your Panasonic Authorized Dealer for details.
53	SUB-ADDRESS PASSWORD		(----	Setting a 20-digit password for secured sub-address communication.
54	FAX FORWARD	1	Invalid	Selecting whether or not the machine performs the Fax Forward. (UF-770 only, see page 93)
		2	Valid	
55	OMR-XMT	1	Off	Setting the home position of the OMR-Transmission parameter in the Select Mode. (see page 91)
		2	On	
56	COVER SHEET	1	Off	Setting the home position of the Cover Sheet parameter in the Select Mode. (See page 89)
		2	On	

Continued on the next page.

Customizing Your Machine

No.	Parameter	Setting Number	Setting	Comments
58	LANGUAGE	1	French	Selecting the language to be shown on the display and reports.
		2	German	
		3	English	
59	PARALLEL PORT I/F [See note 3]	1	Invalid	Selecting whether the machine enables the Printer Interface or PC Interface.
		2	Printer Interface	
		3	PC Interface	
60	OPTION PAGE MEMORY [See note 4]	0	0 MB	Selecting the additional memory size to be allocated as the Page Memory used for the Printer/PC Interface. The amount of additional memory allocated will reduce the size of available Document Memory.
		1	1.5 MB	
65	PRINT COLLATION	1	Invalid	Selecting whether or not the machine prints out documents in sequence. (see page 63)
		2	Valid	
77	LOGO/DEPT. CODE	1	Invalid	Selecting whether or not the machine performs the Multiple Logo or Department Code operation. (UF-770 only)
		2	Multi-LOGO	
		3	Dept.Code	
99	MEMORY SIZE	-	-	Display the amount of base and optional memory installed. (Base Memory + Optional Memory)



- Note:**
1. The contents of Fax Parameter may differ depending on the each country's regulation or specification.
 2. The standard settings are printed on the Fax Parameter List. To print out Fax Parameter List, see page 151.
 3. This parameter is available only when the Parallel Port Interface Option is installed.
 4. This parameter is available only when the Parallel Port Interface Option and Optional Memory Card (2 MB or more) are installed. (See page 169)

Loading Documents ◀

Documents You Can Send

In general, your machine will send any document printed on A4 size paper.

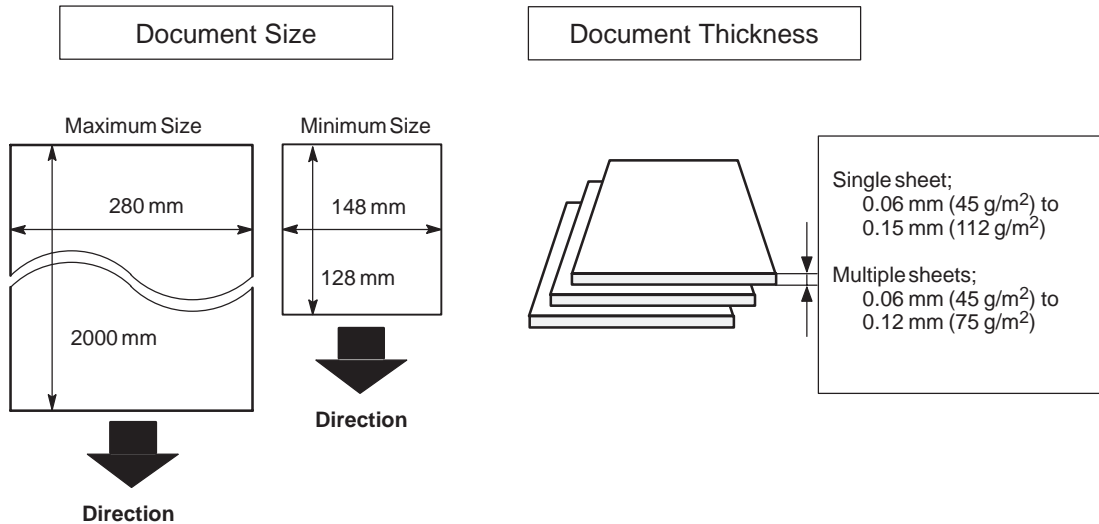

Documents You Cannot Send

You must never try to send documents that are

	<p>Wet</p>		<p>Covered with wet ink or paste</p>
	<p>Too thin (e.g., onionskin, airmail paper, pages from some magazines, etc.)</p>		<p>Wrinkled, curled or folded</p>
	<p>Coated (e.g., glossy paper, etc.)</p>		<p>Chemically processed (e.g., pressure-sensitive paper, carbon-coated paper, etc.) or made of cloth or metal</p>

To transmit these kinds of documents, make a photocopy first and then transmit the copy instead.

▶ Loading Documents

How to Load Documents

1. Be sure the document(s) is free of staples, paper clips and is not torn, greasy or covered by foreign objects.
2. Place the document(s) **FACE DOWN** on the Automatic Document Feeder (ADF) until the leading edge placed into the machine stops.
If you are sending multiple pages, make sure that **the bottom sheet enters first**. You can also stack **up to 50 PAGES** (see Note 1) on the ADF at one time. If you have more than 50 pages, wait until transmission or storing in memory starts as pages feed through, place any remaining pages on top of the last page in the feeder.
3. Adjust the Document Guides to center the document on the ADF.

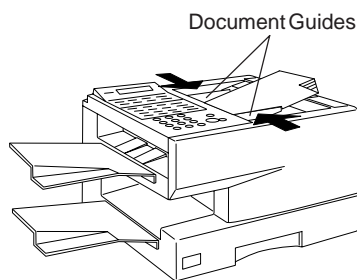

CORRECT

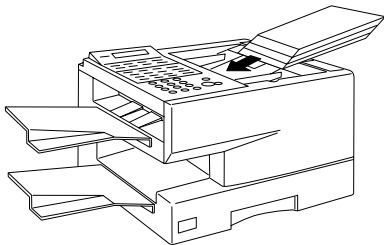

INCORRECT

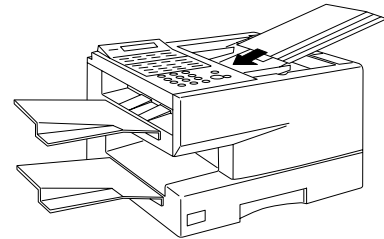

When you set a document on the ADF, the display message will change from date and time (standby) to the following message. You can now change basic transmission settings, or begin the dialling procedure.

ENTER STATION(S)
THEN PRESS START 00%



- Note:**
1. The ADF capacity of UF-550/560 is up to 30 pages.
 2. Transmitting documents longer than 356 mm requires user's assistance.
 3. When transmitting documents longer than A4 size, please extend the sub-tray as shown below.

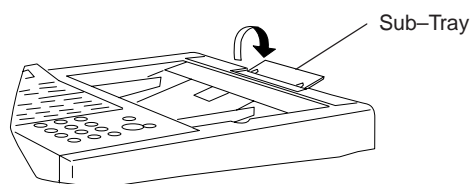

Basic Transmission Settings

You can temporarily change the transmission settings either before or after you place the document on the ADF. These settings are as follows;

- Contrast
- Resolution
- Halftone
- Stamp
- Communication Journal

After your document has been sent, your machine will automatically return to the preset settings.

Contrast

Your machine is preset to **Normal** contrast. If you wish to send a document with lighter contrast, change the setting to **Lighter**. If you wish to send a document with darker contrast, change the setting to **Darker**.

Press **[CONTRAST]** to:

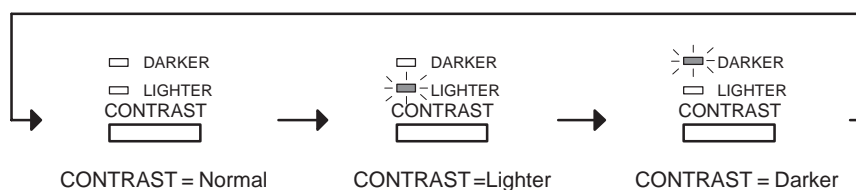

! **Note:** To change the preset Contrast position, change the setting of Fax Parameter No. 01, see page 35.

Resolution

Your machine is preset to **Standard** resolution, which is suitable for most documents. Use **Fine** or **Super Fine** for detailed documents.

Press **[RESOLUTION]** to:

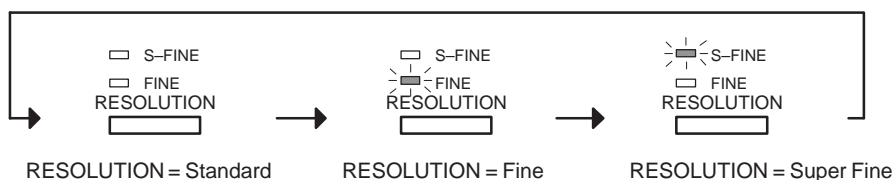

! **Note:** To change the preset Resolution position, change the setting of Fax Parameter No. 02, see page 35.

Basic Transmission Settings

Halftone

The Halftone setting is useful when sending photographs or illustrations with gray tones. Your machine is preset to HALFTONE = Off. You can select either Fast mode or Quality mode.

Press to:

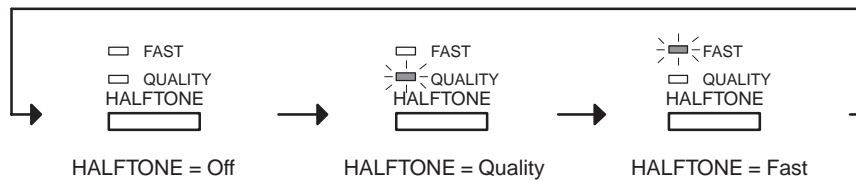

! **Note:** When you select HALFTONE, FAST or QUALITY, your machine will automatically select **Fine Resolution**.

Verification Stamp

The Verification Stamp helps you to confirm successful transmissions by stamping the bottom of each successfully transmitted page with a small ⊗ mark.

Press to:

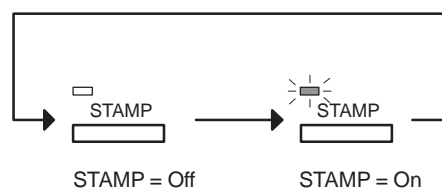

! **Note:** 1. When you store a document in memory, the Verification Stamp will stamp on the document if it is successfully stored in memory. In this case the Verification Stamp is not a confirmation that the document was successfully transmitted. If you wish to disable the use of the Verification Stamp when storing document in memory, change the setting of Fax Parameter No. 28, see page 36.
2. To change the preset Verification Stamp position, change the setting of Fax Parameter No. 04, see page 35.

Basic Transmission Settings

Communication Journal (COMM. JOURNAL)

A Communication Journal lets you verify if the transmission was successful. You can select the condition to print out the communication Journal as follows.

When you set COMM. JOURNAL = **OFF**,

a Communication Journal will not be printed out.

When you set COMM. JOURNAL = **ON**,

a Communication Journal is printed out automatically after every communication.

When you set COMM. JOURNAL = **INC.**,

a Communication Journal is printed out automatically only if the communication has failed.

1

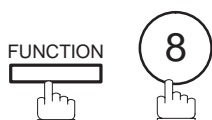

```
SELECT MODE (1-5)
ENTER NO. OR V ^
```

2

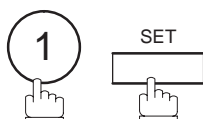

```
COMM. JOURNAL=INC
1:OFF 2:ON 3:INC
```

3

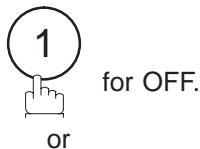

for OFF.

or



for ON (Always print out).

or



for INCOMPLETE only.

```
COMM. JOURNAL=OFF
1:OFF 2:ON 3:INC
```

or

```
COMM. JOURNAL=ON
1:OFF 2:ON 3:INC
```

or

```
COMM. JOURNAL=INC
1:OFF 2:ON 3:INC
```

4

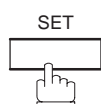

Note: To change the preset Comm. Journal position, change the setting of Fax Parameter No. 12, see page 35.

0000 **Sending Documents**

You can choose either Memory or Direct Transmission.

Use Memory Transmission if:

- You want to send the document to multiple stations.
- You have to retrieve the document immediately.
- You want to take the advantage of Dual Operation design.

Use Direct Transmission if:

- The memory is full.
- You want to send the document real time.

Use Voice Mode Transmit if:

- You want to send the document after talking with the other party.
- You want to send the document after listening to a voice prompting.

Memory Transmission

Your machine quickly stores the document into the machine's memory. Then, starts to dial the telephone number.

If the transmission fails, your machine will re-transmit the remaining unsuccessful page(s) automatically.

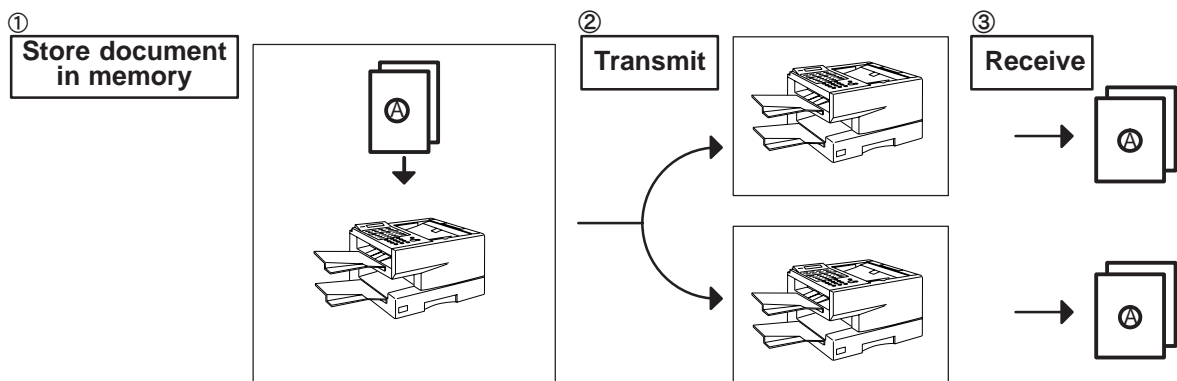



Note: 1. The File Number of the document being stored is shown at the upper right corner of the display while storing the document. It is also printed on the Communication Journal (COMM. JOURNAL), Transaction Journal and File List. The percentage of memory used is shown on the lower right corner of the display after each page is stored.

```
* STORE *      NO.003
      PAGES=02  10%
```

```
* STORE * COMPLETED
TOTAL PAGES=05  30%
```

2. If a memory overflow occurs while storing documents into memory, all the remaining documents in the ADF will be ejected. The machine will prompt on the display, whether to start transmitting those pages which are successfully stored or to cancel the transmission. Press ① to cancel; press ② to transmit. See Specifications, page 166 for the image memory capacity. If no action is taken within 10 seconds, the machine will start transmitting the stored pages.

```
MEMORY OVERFLOW
INFO. CODE=870
```

3. An Information Code will be displayed if the transmission has failed or no answer at the receiving side after the last automatic redial. The document stored for this transmission will be erased from the memory automatically and the information code is printed for the transmission on the Communication Journal (COMM.JOURNAL). If you need to retain the incomplete documents even after the last redial, change Fax Parameter No. 31 (INC. FILE SAVE) to "Valid" in advance.(see page 36) To retry the incomplete documents, refer to page 83.

```
15 PAGES COMPLETED
DELETE? 1:YES 2:NO
```

```
INCOMPLETE
INFO. CODE=XXX
```

4. When a power failure occurs, the document information stored in memory will be lost and a Power Failure Report will be printed automatically after the power is restored. (see page 152)

5. To stop the transmission, press STOP.

The display shows;

```
COMMUNICATION STOP ?
1: YES 2:NO
```

Press ① to stop the transmission. The document you stored will be erased automatically.

If you do not want to erase the documents, change the setting of Fax Parameter No. 31 (INC. FILE SAVE) to "Valid" in advance.(see page 36)

Then the following display will appear and you can select whether to save the file as an incomplete file for editing and retry, or delete the file manually.

```
SAVE AS INCOMP. FILE?
1: YES 2:NO
```

6. If you would like to print a Communication Journal (COMM. JOURNAL) after stopping a transmission, press

① when the display shows:

```
PRINT COMM. JOURNAL?
1: YES 2:NO
```

0000 Sending Documents

Manual Number Dialling

To dial the telephone number manually, follow the steps below.

1



Set document(s) face down.

```
ENTER STATION(S)
THEN PRESS START 00%
```

2

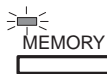

Make sure that the MEMORY lamp is on.
If not, press **MEMORY** to set "On".

3

Enter a telephone number from the keypad.

Ex: ⑤⑤⑤①②③④

```
TEL. NO.
5551234█
```

4



The document is stored into memory with a file number.
Then starts to dial the telephone number.

```
* STORE *      NO.002
      PAGES=01  05%
```

```
* STORE * COMPLETED
TOTAL PAGES=05  25%
```

```
* DIALLING * NO.002
5551234
```



Note: 1. If you need a special access number to get an outside line, dial it first then press **PAUSE** to enter a pause (represented by a "-") before dialling the full number.

Ex: 9 PAUSE 5551234

2. If you are using Pulse dialling and you wish to change to Tone dialling in the middle of dialling, press

TONE (represented by a "/").

The dialling mode will be changed from Pulse to Tone after dialling the digit "/".

Ex: 9 PAUSE TONE 5551234

Sending Documents

One-Touch Dialling

One-Touch Dialling allows you to dial a full number by pressing a single key. To set up the One-Touch keys, see page 29.

1



Set document(s) face down.

```
ENTER STATION(S)  
THEN PRESS START 00%
```

4

2



Make sure that the MEMORY lamp is on.
If not, press **MEMORY** to set "On".

3

Press a One-Touch key.

Ex:

```
<01>(Station name)  
5551234
```

4



The document is stored into memory with a file number.
Then starts to dial the telephone number.

```
* STORE * NO.002  
PAGES=01 05%
```

```
* STORE * COMPLETED  
TOTAL PAGES=05 25%
```

```
* DIALLING * NO.002  
5551234
```

0000 Sending Documents

Abbreviated Dialling

Abbreviated dialling is a speedy way to dial a frequently dialed telephone number by preprogramming the telephone number in the built-in auto-dialer with a 2-digit abbreviated code. To program an abbreviated dialling number, see page 30.

1



Set document(s) face down.

```
ENTER STATION(S)
THEN PRESS START 00%
```

2

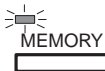

Make sure that the MEMORY lamp is on.
If not, press **MEMORY** to set "On".

3

Press **ABBR** then enter a 2-digit code.

Ex:   

```
[10](Station name)
5553456
```

4



The document is stored into memory with a file number.
Then starts to dial the telephone number.

```
* STORE * NO.002
PAGES=01 05%
```

```
* STORE * COMPLETED
TOTAL PAGES=05 25%
```

```
* DIALLING * NO.002
5553456
```

Sending Documents

Directory Search Dialling

Directory Search dialling allows you to dial a full telephone number by searching the station name entered in One-Touch keys or Abbreviated dialling numbers.

1



Set document(s) face down.

```
ENTER STATION(S)
THEN PRESS START 00%
```

4

2



Make sure that the MEMORY lamp is on.
If not, press **MEMORY** to set "On".

3



```
ENTER LETTER(S)
```

4

Enter full station name or part of a station name from character key (see page 10).

Ex: **P** **A** **N** **A** for searching **PANASONIC**

```
ENTER LETTER(S)
PANA
```

5

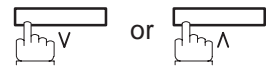

repeatedly until display shows the station name you want to send to.

```
[10] PANASONIC
5553456
```

6

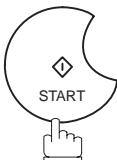

The document is stored into memory with a file number.
Then starts to dial the telephone number.

```
* STORE * NO.002
PAGES=01 05%
```

```
* STORE * COMPLETED
TOTAL PAGES=05 25%
```

```
* DIALLING * NO.002
5553456
```

Sending Documents

Multi-Station Transmission (Broadcasting)

If you have to send the same document(s) to multiple stations, you can save time in feeding the document(s) by using memory transmission. That is, you can store the document(s) into memory and then send it to the station(s) automatically.

1



Set document(s) face down.

```
ENTER STATION(S)
THEN PRESS START 00%
```

2



Make sure that the MEMORY lamp is on.
If not, press **MEMORY** to set "On".

3

Dial by any combination of the following methods:

- One-Touch Dialling
- Abbreviated Dialling
- Manual Number Dialling, press **SET** after each station is entered (UF-770: Up to 32 stations, UF-550/560: Up to 12 stations)
- Directory Search Dialling, press **SET** after each station is entered (For details, see page 46 to 49.)

Ex:



```
<01>(Station name)
5551234
```

```
[10](Station name)
5553456
```

If you want to confirm the number of stations you have entered, press **SET**.

```
2 STN(S) ARE SET
ADD MORE OR START
```

4

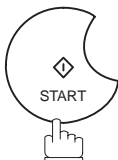

The document is stored into memory with a file number.
Then starts to dial the telephone number in sequence.

```
* STORE * NO.001
PAGES=01 01%
```

```
* DIALLING * NO.001
5551234
```



Note: You can review the stations you entered in step 3 before storing your document into memory by pressing **↓** or **↑**. Press **CLEAR** to clear an entered station show on display if needed.

Direct Transmission

If your machine's memory is full or you wish to send the document real time, use Direct Transmission.

Manual Number Dialling (Direct Transmission)

To dial the telephone number manually, follow the steps below.

1



Set document(s) face down.

ENTER STATION(S)
THEN PRESS START 00%

4

2



Make sure that the lamp goes off.

ENTER STATION 00%

3

Enter a telephone number from the keypad.

Ex: ⑤⑤⑤①②③④

PRESS START TO DIAL
5551234

4

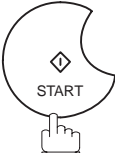

Your machine starts to dial the telephone number.

* DIALLING *
5551234

! **Note:** 1. If you need a special access number to get an outside line, dial it first then press **PAUSE** to enter a pause (represented by a "-") before dialling the full number.
Ex: 9 PAUSE 5551234

2. If you are using Pulse dialling and you wish to change to Tone dialling in the middle of dialling, press **TONE** (represented by a "/").
The dialling mode will be changed from Pulse to Tone after dialling the digit "/".
Ex: 9 PAUSE TONE 5551234

3. To stop the transmission, press **STOP**.
The display shows:

COMMUNICATION STOP ?
1: YES 2: NO

Press ① to stop the transmission. The Communication Journal will not print out regardless of the printout mode setting of the Communication Journal.

0000 **Sending Documents**

One-Touch Dialling (Direct Transmission)

One-Touch Dialling allows you to dial a full number by pressing a single key. To set up the One-Touch keys, see page 29.

1



Set document(s) face down.

```
ENTER STATION(S)  
THEN PRESS START 00%
```

2

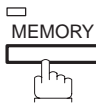

Make sure that the lamp goes off.

```
ENTER STATION  
00%
```

3

Press a One-Touch key.

Ex:

The display will show the One-Touch number and station name. The full number (e.g. 5551234) will then be dialed.

```
<01>(Station name)  
5551234
```

```
* DIALLING *  
5551234
```



Abbreviated Dialling (Direct Transmission)

Abbreviated dialling is a speedy way to dial a frequently dialed telephone number by preprogramming the telephone number in the built-in auto-dialer with a 2-digit abbreviated code. To program an abbreviated dialling number, see page 30.

1  Set document(s) face down.

ENTER STATION(S)
THEN PRESS START 00%

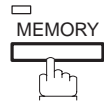
4

2  Make sure that the lamp goes off.

ENTER STATION
00%

3 Press **ABBR** and a 2-digit code.

Ex:   

[10] (Station name)
5553456

The display will show the ABBR number and station name.
The full number (e.g. 5553456) will then be dialed.

* DIALLING *
5553456

0000 Sending Documents

Directory Search Dialling (Direct Transmission)

Directory Search dialling allows you to dial a full telephone number by searching the station name entered in One-Touch keys or Abbreviated dialling numbers.

1



Set document(s) face down.

ENTER STATION(S)
THEN PRESS START 00%

2

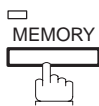

Make sure that the lamp goes off.

ENTER STATION
00%

3



DIRECTORY SEARCH
ENTER LETTER(S)
█

4

Enter full station name or part of a station name from character key (see page 10).

Ex: **P** **A** **N** **A** for searching **PANASONIC**

ENTER LETTER(S)
PANA █

5

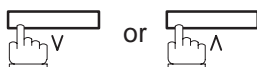

repeatedly until display shows the station name you want to send to.

[10] PANASONIC
5553456

6

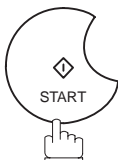

The full number (e.g. 5553456) will be dialed.

* DIALLING *
5553456

Voice Mode Transmission

If you wish to send the document after talking with other party, use Voice Mode Transmission. Your machine requires an optional fax handset or an external telephone.

Off-Hook Dialling

For Off-Hook Dialling, follow these steps

1



Set document(s) face down.

ENTER STATION(S)
THEN PRESS START 00%

2

Lift the fax handset or the external telephone and dial the telephone number from the keypad.

Ex: (5)(5)(5)(1)(2)(3)(4)

3

When you hear the voice of the other party, tell the other party to prepare to receive a document.

Then, when you hear a beep,



and hang up the handset.

ON LINE * XMT *
5551234



Note: To stop the transmission, press **STOP**.

The display shows:

COMMUNICATION STOP ?
1: YES 2: NO

Press **1** to stop the transmission. The Communication Journal will not print out regardless of the printout mode setting of the Communication Journal.

0000 Sending Documents

On-Hook Dialling

For On-Hook Dialling, follow these steps

1



Set document(s) face down.

```
ENTER STATION(S)
THEN PRESS START 00%
```

2

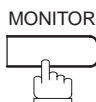

You will hear dial tone through the monitor speaker.

```
* MONITOR *
```

3

Dial the telephone number from the keypad.

Ex: ⑤⑤⑤①②③④

```
* DIALLING *
5551234
```

4

When you hear a beep,



```
ON LINE * XMT *
5551234
```



Note: 1. If you need a special access number to get an outside line, dial it first then press **PAUSE** to enter a pause (represented by a "-") before dialling the full number.

Ex: 9 PAUSE 5551234

2. If you are using Pulse dialling and you wish to change to Tone dialling in the middle of dialling, press

TONE (represented by a "/").

The dialling mode will be changed from Pulse to Tone after dialling the digit "/".

Ex: 9 PAUSE TONE 5551234

Transmission Reservation

You can do the following while sending a document from memory or receiving a document.

- Reserve next transmission into memory for up to 30* different documents. (* UF-550/560 : 8 different documents)
- Reserve a priority transmission.

Memory Transmission Reservation (Dual Access)

If your machine is on-line busy transmitting from memory, receiving or printing received documents, you can reserve transmission by the following procedure.

- 1** Your machine is on-line, the ON LINE lamp is blinking or printing received documents.

```
ON LINE * MEM.XMT *
ID:(Identification)
```

```
ON LINE * RCV *
ID:(Identification)
```

```
* PRINTING *
MEMORY RCV'D DOC
```

```
ENTER STATION(S)
THEN PRESS START 00%
```

- 2** Set document(s) face down.

- 3** MEMORY
Make sure that the MEMORY lamp is on.
If not, press MEMORY to set "On".

- 4** Dial by any combination of the following methods:
 - One-Touch Dialling
 - Abbreviated Dialling
 - Manual Number Dialling, press SET after each station is entered (UF-770: Up to 32 stations, UF-550/560: Up to 12 stations)
 - Directory Search Dialling, press SET after each station is entered
(For details, see page 46 to 49.)

Ex: 01

```
<01>(Station name)
5551234
```

- 5**
Your machine will store the document into memory.

```
* STORE *      NO.005
      PAGES=01  01%
```

```
* STORE * COMPLETED
TOTAL PAGES=05  25%
```

Note: To cancel the memory transmission reservation, see page 80.

0000 Sending Documents

Direct Transmission Reservation (Priority Transmission Reservation)

If you are in a rush to send an urgent document, however there are many files in the memory, use Direct Transmission Reservation to send the urgent document. The urgent document will be sent immediately after the current communication is finished.

Note that you cannot send the documents to multiple stations.

To reserve your machine for sending the urgent documents

- 1 Your machine is on-line, the ON LINE lamp is blinking or printing received documents.

```
ON LINE * MEM.XMT *
ID:(Identification)
```

```
ON LINE * RCV *
ID:(Identification)
```

```
* PRINTING *
MEMORY RCV'D DOC
```

```
ENTER STATION(S)
THEN PRESS START 00%
```

- 2  Set document(s) face down.

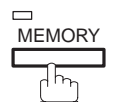
- 3  Make sure that the lamp goes off.

```
ENTER STATION
00%
```

- 4 Dial by using any one of the following methods:
 - One-Touch Dialling
 - Abbreviated Dialling
 - Manual Number Dialling and press **START**
 - Directory Search Dialling and press **START**
(For details, see pages 51 to 54.)

Ex:

You can reserve sending an urgent document to a single station only.

A message "DIRECT XMT RESERVED" will be shown on the display.

```
<01>(Station name)
5551234
```

```
DIRECT XMT RESERVED
<01>(Station name)
```

To cancel the direct transmission reservation

- 1 Make sure the document is on the ADF.

```
DIRECT XMT RESERVED
<01>(Station name)
```

- 2 

```
CANCEL XMT RESERVE ?
1:YES 2:NO
```

- 3  and then remove the document from ADF.

Redialling

Automatic Redialling

If the line is busy or there is no answer, your machine will redial the number up to 3 times at 3 minutes interval. During that time, a message will appear as shown to the right.

WAIT TO DIAL NO.001
(Telephone number)

A file number is shown at the upper right corner of the display if it is a memory transmission file.

Manual Redialling

You can also redial the last dialed number manually by pressing the REDIAL key.

To redial the last dialed number through memory

1



Set document(s) face down.
Make sure that the MEMORY lamp is on.

ENTER STATION(S)
THEN PRESS START 00%

2



TEL. NO.
5551234

3

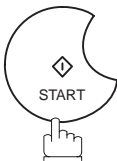

The document is stored into memory with a file number.
Then dials the last dialed number.

* STORE * NO.002
PAGES=01 01%

* DIALLING * NO.002
5551234

To redial the last dialed number through ADF

1



Set document(s) face down.

ENTER STATION(S)
THEN PRESS START 00%

2

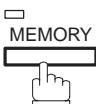

Make sure that the lamp goes off.

ENTER STATION
00%

3



Your machine starts to dial the last dialed number.

TEL. NO.
5551234

* DIALLING *
5551234



Note: 1. While the unit is displaying "WAIT TO DIAL", you can press REDIAL to start redialling immediately.
2. While the unit is displaying "DIALLING" and a message is heard through the monitor that the circuits are busy....., you can press REDIAL to start redialling immediately.

Receiving Documents

Your machine is provided with both automatic and manual reception modes. The selection of either reception mode is made with Fax Parameter No. 17 (RCV MODE).

Automatic Reception

Your machine will receive documents automatically if the Fax Parameter No. 17 (RECEIVE MODE) is set to "Auto" (See page 36).

Manual Reception

You may wish to receive documents manually if you use the telephone line in your office primarily as a personal telephone and occasionally for your facsimile machine. To receive documents manually, change the Fax Parameter No. 17 (RECEIVE MODE) to "Manual" (See page 36) and the following message will be shown on the display.

08-MAR-1997 15:00
MANUAL RCV 00%

To receive documents manually

1 When the telephone rings, lift the handset (See Note). If you hear a beep, the sound tells you that someone wants to send a document.

2 Remove any documents from the ADF.

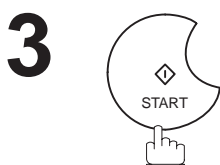

Your machine starts receiving the document.

ON LINE * RCV *

4 Hang up the telephone.



Note: Your machine requires an optional fax handset or an external telephone connected to the TEL jack on the rear of the machine.

Print Reduction

This machine can use Letter, Legal or A4 size plain paper for recording. Sometimes, oversized documents sent to you by the other parties cannot be printed within a single page. When this occurs, the document will be divided into separate pages.

This machine is equipped with a Print Reduction function to solve this problem. You may select the most appropriate setting from the selections described below.

1. Automatic Reduction

Each page of a received document is first stored in memory. Based on the document length, your machine will automatically calculate the suitable reduction ratio (70% to 100%) to print the entire document on a single page. If the received document is extremely long (over 39% longer than the recording paper), the document will be divided into separate pages and printed with no reduction.

2. Fixed Reduction

You can predetermine the reduction ratio from 70% to 100% in 1% steps. The document(s) you received will be reduced to this ratio regardless of the size.

Selecting the Print Reduction Mode

Set Fax Parameters as shown below. (see page 36)

1. To set Automatic Reduction mode.

(1) No. 24 Print Reduction set to "Auto".

2. To set Fixed Reduction mode.

(1) No. 24 Print Reduction set to "Fixed".

(2) No. 25 Reduction Ratio set to any number between 70% through 100%. (see Note)

Ex: A4 to A4 – 96%

A4 to Letter – 90%

Letter to Letter – 96%

Legal to Letter – 75%



Note: If sending side is set to print the header on the outside of the copy area, more reduction ratio will be required.

Receiving Documents

Receiving Oversize Documents

If received document is extremely long (over 39% longer than the recording paper), the document will be divided into separate pages. When printing on separate pages, the bottom 10 mm of first page will be overlapped on top of the next page.

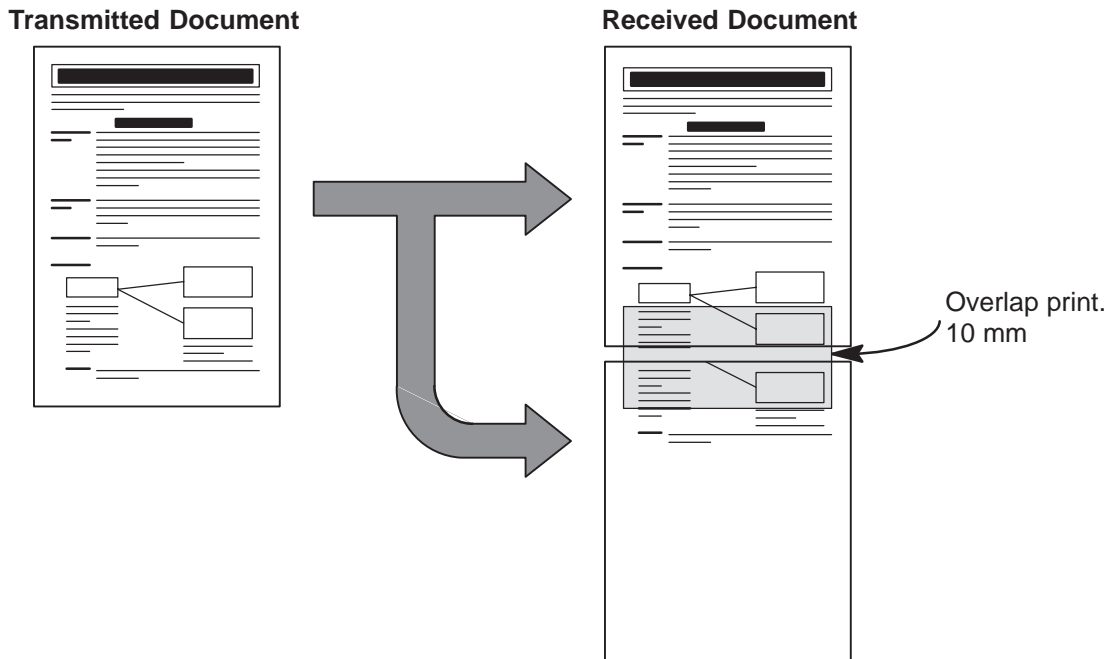

The receiving document is divided into two sheets with overlap printing.



Note: If the reduction method is set to Automatic Reduction mode, the document is printed out with no reduction when printing out separate pages. If the reduction method is set to Fixed Reduction mode, the document is printed out by the ratio you set in Fax Parameter No. 25.

Substitute Memory Reception

If the recording paper runs out or jams or if the toner runs out during reception, the machine automatically starts receiving document into its image data memory. Stored documents are printed automatically after replacing the recording paper or toner cartridge.

1 When the machine finishes the memory reception and there is no recording paper or toner, an Information Code appears on the display.

NO RECORDING PAPER
INFO. CODE=010

2 Install recording paper (see page 18) or replace the toner cartridge (see page 16).

OUT OF TONER
INFO. CODE=041

The machine will automatically start printing the document stored in the memory.

* PRINTING *
MEMORY RCV'D DOC



- Note:**
- If the memory overflows, the machine will stop receiving and release the communication line. The document(s) stored in the memory up to that moment will be printed out.
 - When a power failure occurs,
 - [UF-770]
The document information stored in memory will be saved for up to 1 hour, when the battery is fully charged.
 - [UF-550/560]
The document information stored in memory will be lost. A Power Failure Report will be printed automatically after the power is restored. The report will not be printed if there were no documents in the memory. (see page 152)
 - If you wish to turn off the substitute reception function, change the setting of Fax Parameter No. 22 to "Invalid" (see page 36).

Print Collation Mode

The printing mechanism of the UF-550/560/770 is a Reverse Order Stacking construction. The UF-550/560/770 has a Print Collation Mode that stacks received documents in the correct order. When the Print Collation Mode is enabled, all received documents are stored into memory first, then printed out in Correct Order Stacking. The requirements for the Print Collation Mode to be active are; 1) Fax Parameter No. 65 PRINT COLLATION set to "Valid", and 2) enough remaining memory.

The unit will print in Reverse Order Stacking (Non-Collation Mode) whenever one of the above requirements is not met.

To use this function, we recommend installing an Optional Memory Card. See page 169 (Options and Supplies).

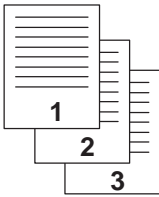
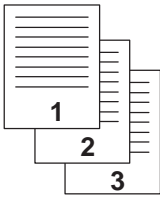
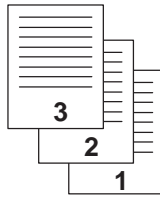
Sending Document Order	Stacking Document Order	
	<p>Correct Order Stacking (Collation Mode)</p> 	<p>Reverse Order Stacking (Non-Collation Mode)</p> 

Making Copies

Your machine has a copy function which can make single or multiple copies. When copying, your machine will automatically select Fine resolution.

1



Set document(s) face down.

```
ENTER STATION(S)  
THEN PRESS START 00%
```

2



```
COPY  
NO. OF COPY=1
```

3

Enter the number of copies.

Ex: ① ⑩

```
COPY  
NO. OF COPY=10
```

4

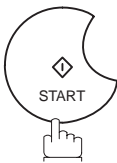

The machine stores the document, then prints the copies.

```
* STORE *      NO.005  
      PAGES=01  01%
```

```
* STORE * COMPLETED  
TOTAL PAGES=05  25%
```

```
* COPY *  
NO. OF COPY=01/10
```



Note: 1. The copy will be reduced automatically depending on the length of original document. If you wish to disable reduction function in copy mode, change the setting of Fax Parameter No. 32 (COPY REDUCTION) to "Invalid" (see page 36).

2. Super Fine resolution is not available when copying.

Timer Controlled Communications

You can send a document to one or multiple stations at any preset time within the next 24 hours. Up to 30* built-in timers can be set for deferred transmission and deferred polling. (* UF-550/560 : 6 built-in timers)

Deferred Transmission

1



Set document(s) face down.

```
ENTER STATION(S)
THEN PRESS START 00%
```

2

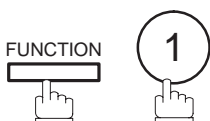

```
DEFERRED COMM. NO. = 1
1:XMT 2:POLLING
```

3



```
DEFERRED XMT
START TIME  :  :
```

4

Enter the start time from the keypad.
(Use a 4-digit, 24-hour clock)

Ex: ②③③① (11:30 p.m.) and

```
ENTER STATION(S)
THEN PRESS START
```

5

Dial by any combination of the following methods:

- One-Touch Dialling
- Abbreviated Dialling
- Manual Number Dialling, press after each station is entered (UF-770: Up to 32 stations, UF-550/560: Up to 12 stations)
- Directory Search Dialling, press after each station is entered
(For details, see page 46 to 49.)

Ex:

```
<01>(Station name)
5551234
```

6



to store documents into the memory.

```
* STORE *      NO.002
      PAGES=01  05%
```

```
* STORE *  COMPLETED
TOTAL PAGES=05  30%
```



- Note:**
1. If you enter a wrong number in Step 4, press then re-enter the right number.
 2. To change or cancel the Deferred Communication settings, see page 75.
 3. When you reserve a deferred transmission without storing document into memory, the following message will be shown on the display after pressing in the last step.

```
DEF DIRECT XMT RSV'D
<01>(Station name)
```

5

Timer Controlled Communications

Deferred Polling

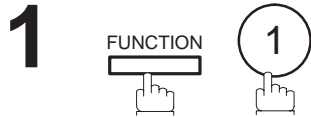

```
DEFERRED COMM. NO.=
1:XMT 2:POLLING
```



```
DEFERRED POLLING
PASSWORD=
```

3 Enter a 4-digit polling password.

Ex: 9 8 7 6 and SET

```
DEFERRED POLLING
START TIME :
```

4 Enter the start time from the keypad.
(Use a 4-digit, 24-hour clock)

Ex: 0 3 3 0 (3:30 a.m.) and SET

```
ENTER STATION(S)
THEN PRESS START
```

5 Dial by any combination of the following methods:

- One-Touch Dialling
- Abbreviated Dialling
- Manual Number Dialling, press SET after each station is entered (UF-770: Up to 32 stations, UF-550/560: Up to 12 stations)
- Directory Search Dialling, press SET after each station is entered (For details, see page 46 to 49.)

Ex: 01

```
<01>(Station name)
5551234
```

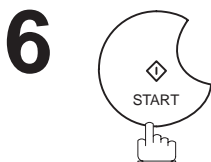

```
* STORE * NO.001
```

! **Note:** 1. If you enter a wrong number in Step 3, press CLEAR, then re-enter the right number.
2. To change or cancel the Deferred Communication settings, see page 75.

Polling means calling other station(s) to retrieve a document. The other station must know in advance that you will call and must have a document set on the ADF or stored in the memory. You may need to set a polling password, shared by the other station, to ensure security.

Setting Polling Password



If the polling password does not match with the polled station, your polling request will be refused automatically.

To set the polling password, follow the steps below.

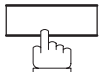

1   

2   

3    

4 Enter a 4-digit polling password.
Ex:    

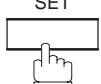

5  

-  **Note:** 1. Polling might not function with all fax machines. We suggest you attempt a trial polling before you actually poll important documents.
2. If a password is not set in the polled station, you may poll the other station even though your machine has a password.

0000 Polling

Preparing to be Polled

In order to let other stations poll your machine, you must prepare your machine with a document stored in memory. Be sure to set the polling password before storing the document into memory. After being polled, the documents stored in the memory will be erased automatically. To retain the documents in memory so that they can be polled repeatedly change Fax Parameter No. 27, Polled File Save to Valid.

1



Set document(s) face down.

```
ENTER STATION(S)
THEN PRESS START 00%
```

2

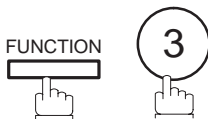

```
POLLING          NO. =
1: POLLING 2: POLLED
```

3



```
POLLED
PASSWORD=1234
```

4

Enter a 4-digit polling password. (see Note 3)

Ex: ④③②①

```
POLLED
PASSWORD=4321
```

5



The document(s) will be stored into memory.

```
* STORE *      NO.015
PAGES=01  01%
```

```
* STORE * COMPLETED
TOTAL PAGES=05  24%
```



- Note:**
1. You can still send or receive documents even when set to be polled.
 2. Only 1 polled file can be stored in memory. If you need to add document into the same polled file, see page 82.
 3. If you have set the polling password in Fax Parameter No. 26, the password will appear on the display. You can still change the password temporarily by overwriting it with a new one.

To Poll Documents from Another Station

The following procedure lets you poll a document from one or multiple stations. Be sure to set the polling password before polling (see page 67).

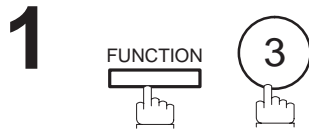

POLLING NO. = 
1: POLLING 2: POLLED



POLLING
PASSWORD=1234

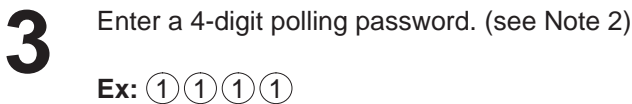

POLLING
PASSWORD=1111

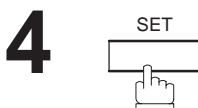

ENTER STATION(S)
THEN PRESS START

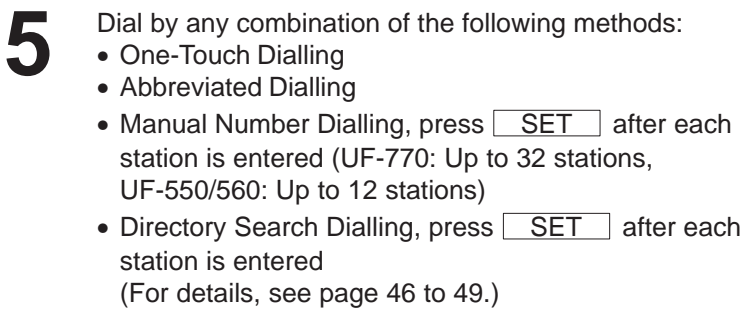

Ex:

<01>(Station name)
5551234

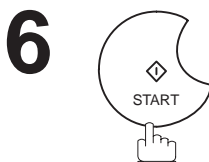

* STORE * NO.001



-  **Note:** 1. You can review the entered stations in step 4 by pressing or key, press to erase the displayed station as needed.
2. If you have set the polling password in Fax Parameter No. 26, the password will appear on the display. You can still change the password temporarily by overwriting it with a new one.

Program Keys

Your fax machine has special Program Keys. These keys are useful if you frequently need to send or poll the same group of stations. You can use these keys to store a sequence of stations to be polled, a deferred transmission or polling sequence, an additional One-Touch key or a One-Touch group key.

Setting for Deferred Transmission

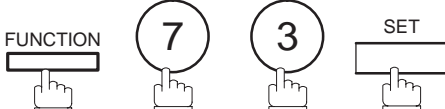
To set a Program Key for deferred transmission

1  

2 Ex: 

3  

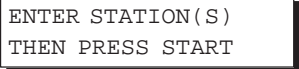
4 Enter the starting time using 4 digits.
Ex: ②③③① (11:30 p.m.) and 

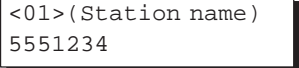
5 Enter the station numbers by using One-Touch Key, or and a 2-digit code.
Ex: 

You may use the or keys to review the entered station(s) before going to next step. If you find an error, press to erase the displayed station.

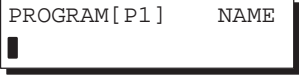
6  

7 Enter the station name (up to 15 character) using the Character keys (see page 10).
Ex: PROG.A and 

You can now set other Program Keys by repeating the procedures from Step 2, or return to standby by pressing .

Setting for Normal Polling

To set a Program Key for normal polling

1

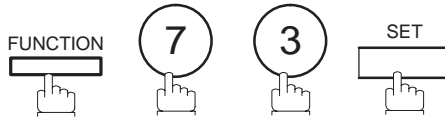

```
PROGRAM[P ]
PRESS PROGRAM KEY
```

2

Ex:

```
PROGRAM[P1] NO.= |
1:PROG 2:ONE-TOUCH
```

3

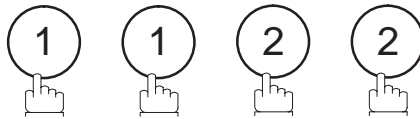

```
POLLING
PASSWORD=||||
```

4

Enter a 4-digit polling password.

Ex: (1)(1)(1)(1) and

The polling password appears if it has been previously set.

```
ENTER STATION(S)
THEN PRESS START
```

5

Enter the station numbers by using One-Touch Key, or and a 2-digit code.

Ex:

You may use the or keys to review the entered station(s) before going to next step. If you find an error, press to erase the displayed station.

```
<01>(Station name)
5551234
```

6



```
PROGRAM[P1] NAME
|
```

7

Enter the station name (up to 15 character) using the Character keys (see page 10).

Ex: PROG.A and

You can now set other Program Keys by repeating the procedures from Step 2, or return to standby by pressing .

```
PROGRAM[P ]
PRESS PROGRAM KEY
```

5

Program Keys

Setting for Deferred Polling

To set a Program Key for deferred polling

1

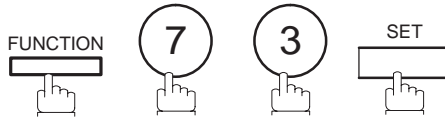

```
PROGRAM[P ]
PRESS PROGRAM KEY
```

2

Ex: P1

```
PROGRAM[P1] NO.=
1:PROG 2:ONE-TOUCH
```

3

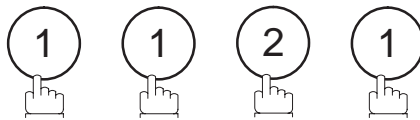

```
DEFERRED POLLING
PASSWORD=
```

4

Enter a 4-digit polling password.

Ex: ①①①① and SET

```
PROGRAM[P1]
START TIME :
```

The polling password appears if it has been previously set.

5

Enter the starting time.

Ex: ②②①① (10:00p.m.) and SET

```
ENTER STATION(S)
THEN PRESS START
```

6

Enter the station numbers by using One-Touch Key, or ABBR and a 2-digit code.

Ex: 01

```
<01>(Station name)
5551234
```

You may use the ∇ or \blacktriangle keys to review the entered station(s) before going to next step. If you find an error, press CLEAR to erase the displayed station.

7



```
PROGRAM[P1] NAME
```

8

Enter the station name (up to 15 character) using the Character keys (see page 10).

Ex: PROG.A and SET

```
PROGRAM[P ]
PRESS PROGRAM KEY
```

You can now set other Program Keys by repeating the procedures from Step 2, or return to standby by pressing STOP.

Setting for Group Dialling

To set a Program Key for Group Dialling

1

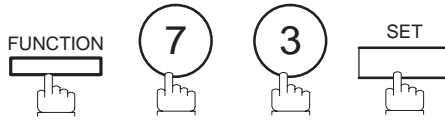

```
PROGRAM[P ]
PRESS PROGRAM KEY
```

2

Ex:

```
PROGRAM[P1] NO.= |
1:PROG 2:ONE-TOUCH
```

3

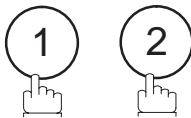

```
ENTER STATION(S)
THEN PRESS START
```

4

Enter the station numbers by using One-Touch Key, or and 2-digit code.

Ex: and **1** **0**

You may use the or keys to review the entered station(s) before going to next step. If you find an error, press to erase the displayed station.

```
<01>(Station name)
5551234
```

```
[10](Station name)
5553456
```

5



```
PROGRAM[P1] NAME
|
```

6

Enter the station name (up to 15 character) using the Character keys (see page 10).

Ex: PROG.A and

You can now set other Program Keys by repeating the procedures from Step 2, or return to standby by pressing .

```
PROGRAM[P ]
PRESS PROGRAM KEY
```

5

Program Keys

Setting for One-Touch Key

To set a Program Key for One-Touch Key

1

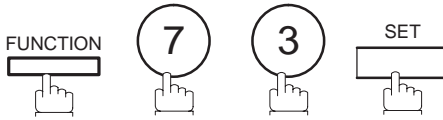

```
PROGRAM[P ]
PRESS PROGRAM KEY
```

2

Ex: P1

```
PROGRAM[P1] NO.=
1:PROG 2:ONE-TOUCH
```

3



```
[P1]
ENTER TEL. NO.
```

4

Enter a telephone number (up to 36 digits including pauses and spaces).

Ex: 9 PAUSE 5 5 5 SPACE
1 2 3 4

```
[P1]
9-555 1234
```

5

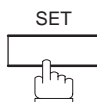

```
[P1] ENTER NAME
9-555 1234
```

6

Enter the station name (up to 15 character) using the Character keys (see page 10).

Ex: PROG.A and SET

```
PROGRAM[P ]
PRESS PROGRAM KEY
```

You can now set other Program Keys by repeating the procedures from Step 2, or return to standby by pressing STOP.

Changing or Erasing Program Key Settings

To change the settings in a Program Key, follow the procedure on setting Program Keys on pages 70 to 74.

- Start time or station(s) for deferred transmission
- Station(s) for normal polling
- Start time or station(s) for deferred polling
- Station(s) for group dialling
- Telephone number and station name for One-Touch key

To erase the settings in a Program Key

1

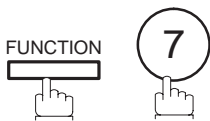

```
SET MODE      (1-6)
ENTER NO. OR V ^
```

2

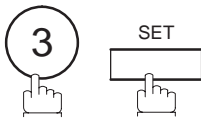

```
PROGRAM[P ]
PRESS PROGRAM KEY
```

3

Press the Program key you want to erase.

Ex:

```
PROGRAM[P1]   NO.=1
1:PROG 2:ONE-TOUCH
```

4

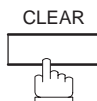

```
PROGRAM[P1]   NO.=1
1:PROG 2:ONE-TOUCH
```

5

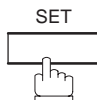

```
PROGRAM[P ]
PRESS PROGRAM KEY
```

You can now erase other Program Keys by repeating the procedures from Step 3, or return to standby by pressing

.

0000 Edit File Mode

Your machine has a document image memory which enables you to reserve memory transmission, memory deferred transmission, memory polling and so on.

After reserving the communications in memory, you may need to change the settings of the communications while it is still in memory. This section describes how to use the file editing features.

Printing a File List

The contents of the communication settings may have to be modified or deleted. To verify the contents, follow these steps below to print out a file list.

1			EDIT FILE MODE (1-6) ENTER NO. OR V ^
2			1:FILE LIST? PRESS SET TO SELECT
3			FILE LIST 1:PRINT 2:VIEW
4			* PRINTING * FILE LIST

Sample File List

```

***** -FILE LIST- ***** DATE 08-MAR-1997 ***** TIME 15:00 *** P.01

(1)  (2)          (3)          (4)          (5)  (6)
FILE COMM. TYPE   CREATED TIME  START TIME  PAGES DESTINATION(S)
No.

001 DEFERRED XMT  07-MAR 13:20  20:30      [01]
002 MEM.DEF.XMT  07-MAR 13:20  22:30      003 [11] [12] [13] [16] [17]

                                -PANASONIC -

***** -HEAD OFFICE - ***** 201 555 1212- *****
  
```

Explanation of Contents

- | | |
|------------------------------|---|
| (1) File number | :If the file is now being executed, a "*" is indicated on the left of the file number. |
| (2) Communication type | |
| (3) Stored date/time | :Date/time that these files were stored. |
| (4) Executing time | :If the file is a Timer Controlled Communication, the start time is printed in this column.
If the file is an incomplete file, "INCOMP" is printed in this column. |
| (5) Number of stored page(s) | |
| (6) Destination | :ABBR. No./One-Touch No./Manual Dialling No. |

Viewing the Contents of a File List



You can also verify the contents of a file list by showing it on the display without printing a file list, follow the steps below.

1   EDIT FILE MODE (1-6)
ENTER NO. OR V ^

2  1:FILE LIST?
PRESS SET TO SELECT

3  FILE LIST
1:PRINT 2:VIEW

4  USE THE V ^ KEYS TO
SCROLL EACH FILE

5  or  repeatedly until the display shows a file you want to edit.

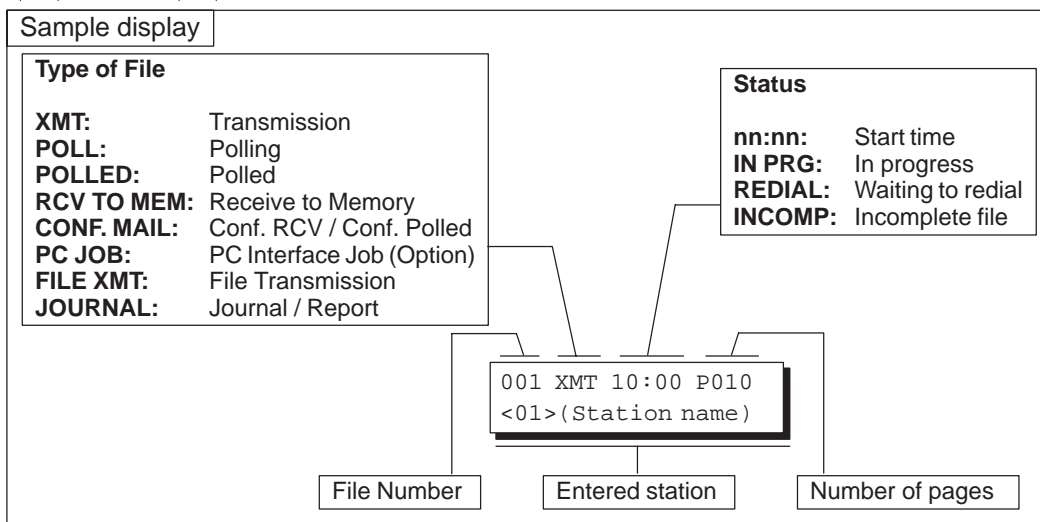

6 

▶ Edit File Mode

Changing the Start Time or the Station of a File

To change the start time and/or stations in a communication file, follow the steps below.

1

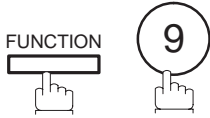

```
EDIT FILE MODE (1-6)
ENTER NO. OR V ^
```

2

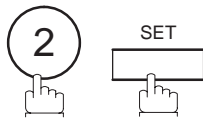

```
ENTER FILE NO. OR V ^
FILE NO. = ███
```

3

Enter the file number or use or to select the file that you want to change.

Ex: 001

```
ENTER FILE NO. OR V ^
FILE NO. =001
```

4



```
DEFERRED XMT
START TIME 20:30
```

5

Enter a new start time.

Ex: 0600 (6:00 AM)
(If you do not have to change the time, skip to step 6.)

```
DEFERRED XMT
START TIME 06:00
```

6



```
TEL. NO.
5551234
```

7 To delete the station(s), press or key until the station you want to delete appears. Then press .

or

Enter the station(s) you want to add.

Ex:

```
ENTER STATION(S)
THEN PRESS START
```

```
1 STN(S) ARE SET
ADD MORE OR START
```

5

8

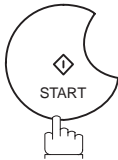

Note: 1. Your machine cannot change the start time and/or stations in the file while it is being sent or waiting to redial.

2. If the file is not a Deferred Communication File, the following message is shown on the display.

```
SET DEFERRED COMM. ?
1: YES 2: NO
```

Press ① to change the type of the file for deferred communication file.

3. If you edit the file that is saved as an incomplete file, after pressing in step 8, your machine will prompt you to execute the file immediately or not.

The display shows;

```
RETRY INCOMP. FILE?
1: YES 2: NO
```

Press ① to execute the file immediately.

0000 Edit File Mode

Deleting a File

To delete the file in memory, follow the steps below.

1

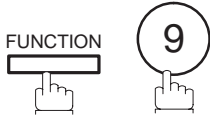

```
EDIT FILE MODE (1-6)
ENTER NO. OR V ^
```

2

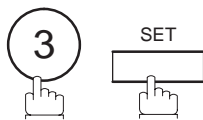

```
ENTER FILE NO. OR V ^
FILE NO. = █
```

3

Enter the file number or use or to select the file that you want to delete.

Ex: ①①① (see Note 2)

```
ENTER FILE NO. OR V ^
FILE NO. =001
```

4



```
DELETE FILE NO.001?
1: YES 2: NO
```

5



Enter the next file number you want to delete or press to return to standby.

```
* DELETING *
FILE NO. =001
```

```
ENTER FILE NO. OR V ^
FILE NO. = █
```



Note: 1. Your machine cannot delete the file while it is being sent.

2. Enter as the file number and press to delete all files (except the file in progress).
The following message is shown on the display.

```
DELETE ALL FILES ?
1: YES 2: NO
```

Press to delete all files.

Printing Out a File

To print the contents of the communication file, follow the steps below.

1

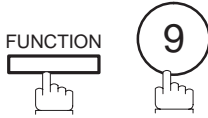

```
EDIT FILE MODE (1-6)
ENTER NO. OR V ^
```

2

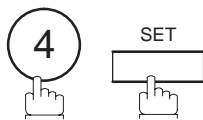

```
ENTER FILE NO. OR V ^
FILE NO. = ███
```

3

Enter the file number or use or to select the file that you want to print.

Ex: ①①①

```
ENTER FILE NO. OR V ^
FILE NO. =001
```

4

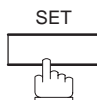

Your machine will print the file. The document(s) will remain in memory even after printing of the file.

```
* PRINTING *
PAGE=001/003
```



Note: Your machine cannot print the file while it is being sent.

0000 Edit File Mode

Adding Documents into a File

To add documents into the file, follow the steps below.

1



Set document(s) face down.

```
ENTER STATION(S)  
THEN PRESS START 00%
```

2

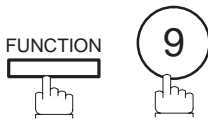

```
EDIT FILE MODE (1-6)  
ENTER NO. OR V ^
```

3

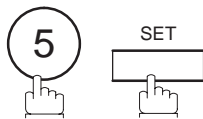

Enter the file number or use or to select the file that you want to add.

```
ENTER FILE NO. OR V ^  
FILE NO. = ■■■
```

Ex: 0 0 1

```
ENTER FILE NO. OR V ^  
FILE NO. =001
```

4

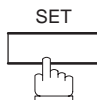

Your machine will start storing the document(s) into a file.

```
* STORE *      NO.001  
PAGES=01  10%
```



Note: Your machine cannot add the document into the file while it is being sent or waiting to redial.

Retry an Incomplete File

If a memory communication has been unsuccessful due to a busy line or no answer, the document you stored is automatically erased from memory after the last redial.

If you need to retain the document even if the communication failed, change the setting of Fax Parameter No. 31 (INC. FILE SAVE) to Valid in advance. (see page 36)

To retry the incomplete file, print a File List to check the file number (see page 76). Then, follow these steps below.

1



EDIT FILE MODE (1-6)
 ENTER NO. OR V ^

2



ENTER FILE NO. OR V ^
 FILE NO. = ███

3 Enter the file number or use or to select the file that you want to retry.

Ex: ①①①

ENTER FILE NO. OR V ^
 FILE NO. = 001

4



Your machine will retry the file and start dialling immediately.

* STORE * NO.001

* DIALLING * NO.001
 5551234

-  **Note:** 1. Please refer to page 78 and 79 to confirm or change the entered telephone number for the file.
 2. If you set Fax Parameter No.31 to Valid, all incomplete files remain in the memory. To avoid memory overflow, please check the memory content frequently. We recommend that optional memory be installed when this function is used (see page 169).

Fax Access Code

The Fax Access Code prevents an unauthorized user from operating the machine. Once a 4-digit Fax Access Code is registered, no one can operate the machine without entering the correct access code. Automatic Receiving, however, is always available. After you complete any operation, such as mode setting or transmission, and the display returns to standby, you have to reenter the access code in order to use the machine again. Registering the Fax Access Code does not affect the use of the machine in any other way.

Setting the Fax Access Code

1  

SET MODE (1-6)
 ENTER NO. OR V ^

2  

FAX PARAMETER(01-99)
 NO. = █

3   

38 FAX ACCESS CODE █ █ █ █

4 Enter a 4-digit Fax Access Code.
 Ex: ①②③④

38 FAX ACCESS CODE
 1234



5 

For UF-550/560 skip to step 7. (The UF-550/560 cannot select restriction level. ALL only.)

38 FAX ACCESS CODE
 1:ALL 1234

6 Select Restriction Level.
 ① for All operations
 ② for Setting and Printout of Fax Parameters only.
 Ex: ②

38 FAX ACCESS CODE
 2:FAX PARA. 1234

7  

! **Note:** To erase the Fax Access Code, enter Access Code and press **SET** and follow the procedure above to step 3, then press **CLEAR** **SET** and **STOP**.

Fax Access Code ◀

Operating Your Machine with the Fax Access Code (Restrict all operations)

- 1** Enter the Fax Access Code.
Ex: ①②③④

08-MAR-1997 15:00
ACCESS CODE= █

08-MAR-1997 15:00
ACCESS CODE= █ █ █ █

- 2** 



Now you can operate the machine using normal procedures.

08-MAR-1997 15:00
00%

5

Operating Your Machine with the Fax Access Code (Restrict access of Fax Parameters only) [For UF-770 only]

The UF-770 can be selected to restrict the operations of setting and printing the Fax Parameters only.
Ex: When Setting the Fax Parameter.

- 1**  

SET MODE (1-6)
ENTER NO. OR V ^

- 2**  

INPUT ACCESS CODE
█ █ █ █

- 3** Enter a 4-digit Fax Access Code.
Ex: ①②③④

INPUT ACCESS CODE
1234

- 4** 







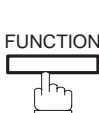

Now you can operate the machine using normal procedures.

FAX PARAMETER(01-99)
NO. = █

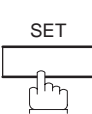
Receive To Memory

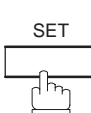
This feature is used to secure all received documents by storing them into the memory. To print out the document from memory, the authorized operator must enter the correct password.

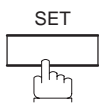
Setting the RCV To Memory Password

1	 	SET MODE (1-6) ENTER NO. OR V ^
2	 	FAX PARAMETER(01-99) NO. = █
3	  	37 RCV TO MEMORY 
4	Enter a 4-digit RCV to Memory Password. Ex: ①②③④	37 RCV TO MEMORY 1234
5	 	

Setting RCV To Memory

1	 	SELECT MODE (1-5) ENTER NO. OR V ^
2	 	RCV TO MEMORY=OFF 1:OFF 2:ON 3:PRINT
3		RCV TO MEMORY=ON 1:OFF 2:ON 3:PRINT
4		08-MAR-1997 15:00 < RCV TO MEMORY >

! **Note:** 1. When the memory overflows, the machine will stop receiving and release the line. The machine will not answer the next incoming call until there is space available in the memory.
 2. We recommend that optional memory be installed when this function is used. See page 166 for Image Memory Capacity.

Receive To Memory

Printing Out Documents

After receiving a document with Receive To Memory feature, the following message will appear on the display.

MESSAGE IN MEMORY
< RCV TO MEMORY >

To print the document, follow these steps below.

1

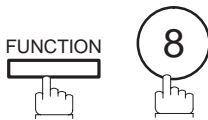

SELECT MODE (1-5)
ENTER NO. OR V ^

5

2

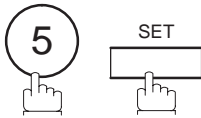

RCV TO MEMORY=ON
1:OFF 2:ON 3:PRINT

3



RCV TO MEMORY=PRINT
1:OFF 2:ON 3:PRINT

4



INPUT PASSWORD 

5

Enter the password to print the documents.
(see Note 1)

Ex: ①②③④

INPUT PASSWORD 1234

6



Machine will start to print the documents.

* PRINTING *
MEMORY RCV'D DOC



Note: 1. If the password has not been set, your machine will not prompt you to enter the password.

The documents will be printed immediately after pressing **SET** in step 4.

2. Once you set RCV TO MEMORY feature to On, the password cannot be changed (Fax Parameter No. 37 will not be shown on the LCD display). If you wish to change the password, set RCV TO MEMORY feature to Off first. Then change the password (see page 86).

Distinctive Ring Detector (DRD)

This function is only effective for companies in countries which offer the DRD Service.

Your machine has a special feature in conjunction with an optional service provided by many local telephone companies. It can distinguish up to 2 telephone numbers with a corresponding ring pattern identifying each number. "DRD" lets you provide multiple phone numbers, one for your fax, business or personal use with only one single phone line.

Please check with your local telephone company on the availability of this service in your area.

Your machine can be programmed to respond to the specified ring pattern only for the DRD Service. To enable your machine to detect the ring pattern only for fax communication, change the setting of Fax Parameter No. 30 (see page 36).

The following table shows a typical example with 2 telephone numbers on a single phone line.

Telephone No.	Usage	Distinctive Ring Sound	Ring Pattern
555-1111	Phone	<i>Riiing.....Riiing.....</i>	Standard Ring
555-2222	Fax	<i>Ring...Ring.....Ring...Ring.....</i>	Double Ring

! **Note:** "Riiing" means a long ringing sound and "Ring" means a short ringing sound.

The following illustration shows a typical set up, with your machine set to detect "double ring" pattern.

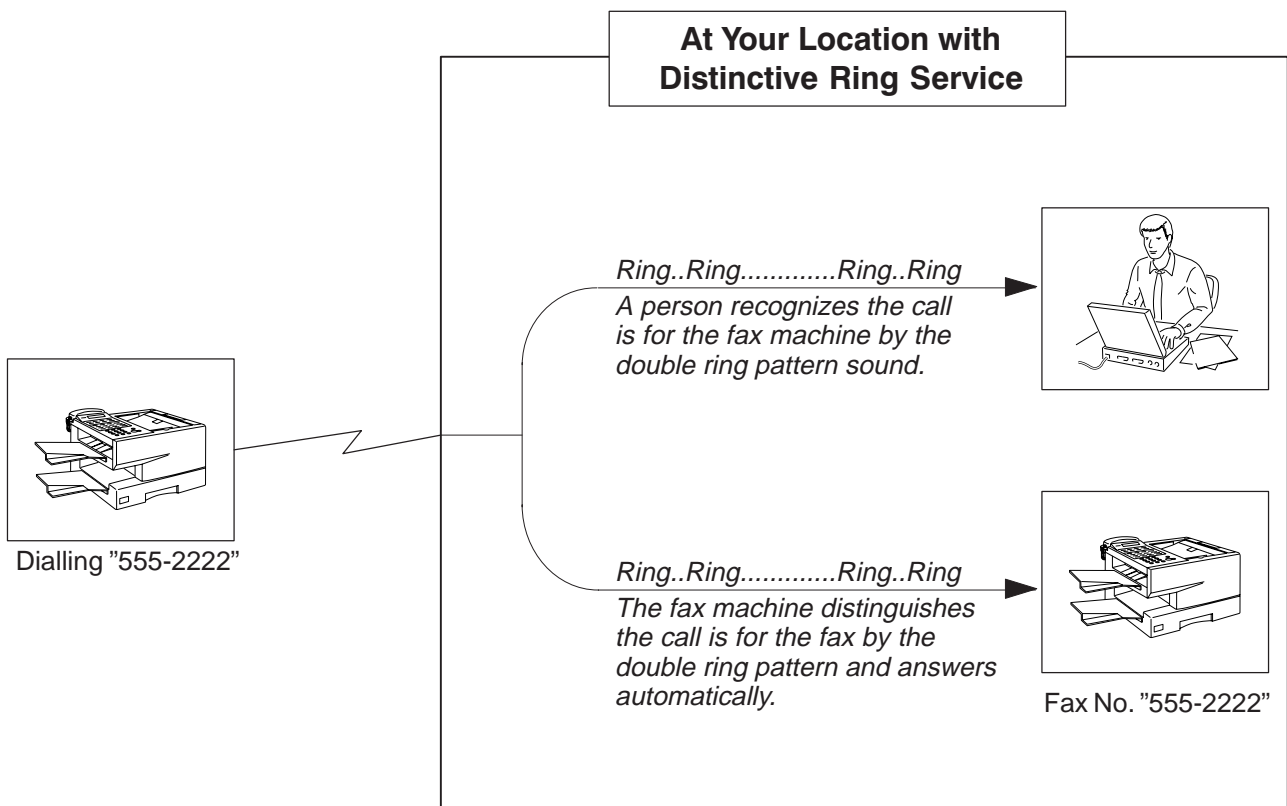

General Description

A Fax Cover Sheet can be automatically attached to your transmit document(s) that shows the recipient's name, originator's name and the number of pages attached.

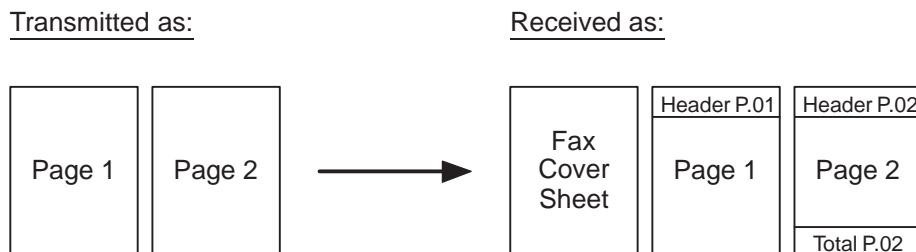

To use the Fax Cover Sheet



To attach the Fax Cover Sheet for a transmission, follow the procedure below.

- 1



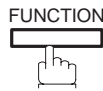

Set document(s) face down.

ENTER STATION(S)
THEN PRESS START 00%
- 2

SELECT MODE (1-5)
ENTER NO. OR V Λ

SELECT MODE (1-5)
ENTER NO. OR V Λ
- 3

COVER SHEET=OFF
1:OFF 2:ON

COVER SHEET=OFF
1:OFF 2:ON
- 4



for OFF (Cover Sheet is not attached)

COVER SHEET=OFF
1:OFF 2:ON

or



for ON (Cover Sheet is attached)

COVER SHEET=ON
1:OFF 2:ON

or
- 5

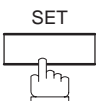

ENTER STATION(S)
THEN PRESS START 00%

ENTER STATION(S)
THEN PRESS START 00%
- 6

Dial the station(s)

Ex:

- !** **Note:** 1. To change the preset Fax Cover Sheet Setting, change the setting of Fax Parameter No. 56, see page 37.
2. This function is available for memory or direct transmission mode.
3. The Fax Cover Sheet is not counted in the number of pages column of the journals.

Fax Cover Sheet

Fax Cover Sheet Sample

***** FACSIMILE COVER SHEET *****

(1)
08-MAR-1997 15:00

(2)
Message To:

SALES DEPT.

(3)
Message From:

PANASONIC
201 555 1212

(4)
02
Page(s)
Following This Cover Page

Explanation of Contents

- (1) Starting time of communication
- (2) Recorded name in One-touch. ABBR. No. Dialling or dialed telephone number.
- (3) Your LOGO (up to 25 characters) and ID Number (up to 20 digits)
- (4) A number of following pages. This information is not shown when it transmitting by Direct Transmission Mode.

General Description

This feature is designed to work with a store and forward system (i.e. UF-M500 Multi-Channel Fax Gateway) that utilize OMR (Optical Mark Recognition) sheet to obtain routing information to automatically relay the fax messages to its final destination.

When sending a document with the OMR-XMT feature set to "On", the process of the following 2 operations will be changed

- Automatic Page Re-transmission**
 When the OMR-XMT feature is set to "On" and the memory transmission failure occurs, the automatic re-transmission will start from the 1st page including the OMR sheet rather than from the failed page.
- Automatic Page Numbering**
 When the OMR-XMT is set to "On", the automatic page numbering on the header of each page will start from the 2nd page instead of the 1st page, which is your OMR sheet.

Table 1: Documents sent with the OMR-XMT feature set to "On"

Transmitted Pages	Received by the System	Received by the final destination
 <p>Diagram showing transmitted pages: OMR sheet, Page 1, and Page 2.</p>	 <p>Diagram showing pages received by the system: OMR sheet, Page 1, and Page 2. Headers are labeled "Header P.01" and "Header P.02".</p>	 <p>Diagram showing pages received by the final destination: Page 1 and Page 2. Headers are labeled "Header P.01" and "Header P.02".</p>

Table 2: Documents sent with the OMR-XMT feature set to "Off"

Transmitted Pages	Received by the System	Received by the final destination
 <p>Diagram showing transmitted pages: OMR sheet, Page 1, and Page 2.</p>	 <p>Diagram showing pages received by the system: OMR sheet, Page 1, and Page 2. Headers are labeled "Header P.01", "Header P.02", and "Header P.03".</p>	 <p>Diagram showing pages received by the final destination: Page 1 and Page 2. Headers are labeled "Header P.02" and "Header P.03".</p>

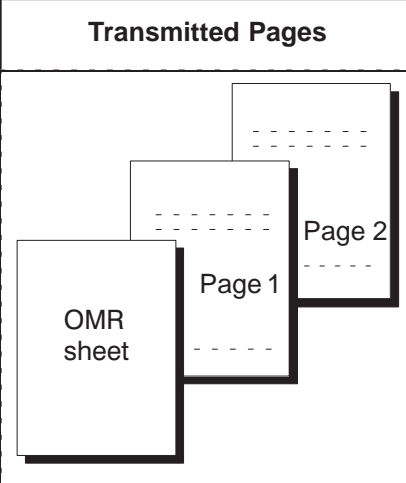
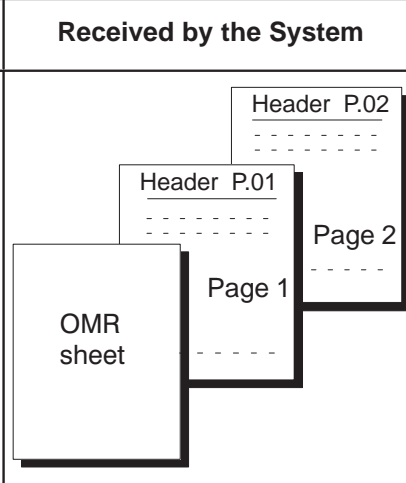
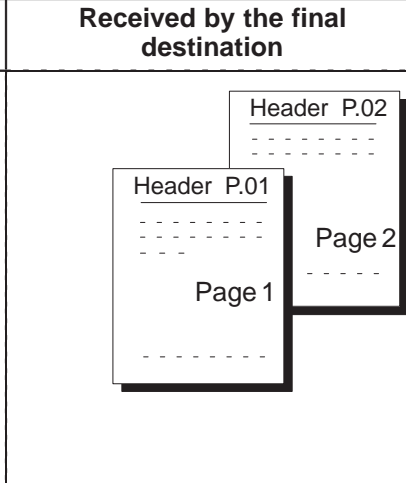
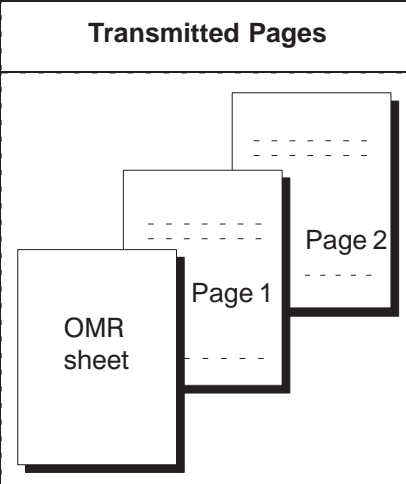
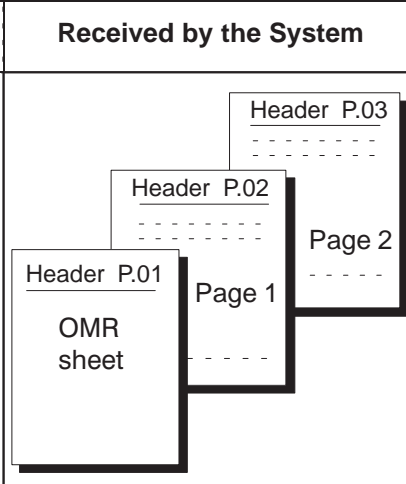
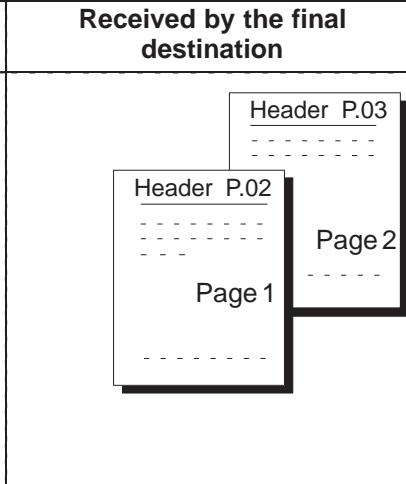

OMR Transmission

Sending Documents with your OMR Sheet



To use the OMR Transmission, select OMR-XMT = OFF or ON for each Transmission by following the procedure below.

- 1**  Set document(s) face down.



ENTER STATION(S)
 THEN PRESS START 00%

- 2**  

SELECT MODE (1-5)
 ENTER NO. OR V ^

- 3**  

OMR-XMT=OFF
 1:OFF 2:ON

- 4**  for OFF
 or
 for ON

OMR-XMT=OFF
 1:OFF 2:ON

or

OMR-XMT=ON
 1:OFF 2:ON

- 5** 

ENTER STATION(S)
 THEN PRESS START 00%

- 6** Dial the station(s)

Ex:

- !** **Note:** 1. To change the preset OMR Transmission Setting, change the setting of Fax Parameter No. 55, see page 37.
 2. This function is available for memory or direct transmission mode.
 3. The OMR Sheet is counted in the number of pages column of the journals.
 4. When using the OMR Transmission, the Cover Sheet function will be turned "Off" automatically.



Setting Fax Forward

This feature allows all incoming faxes to be forwarded to the station registered in the abbreviated dialling number [00]. Once the faxes are received in the memory, the machine will dial the telephone number registered in the abbreviated dialling number [00] and transmit the received document(s). This function is convenient when you would like to receive faxes in another place (i. e. your home) at night or during a holiday.

1 First register a telephone number for the abbreviated dialling number [00] where to transfer the receiving faxes. (see page 30)

2

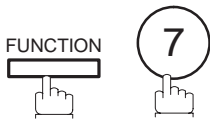

```
SET MODE      (1-6)
ENTER NO. OR V Λ
```

3

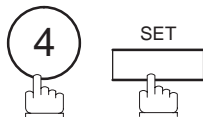

```
FAX PARAMETER(01-99)
NO. = █
```

4



```
54 FAX FORWARD
1: INVALID
```

5



```
54 FAX FORWARD
2: VALID
```

6

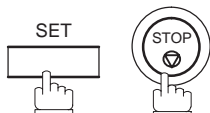

```
08-MAR-1997 15:00
< FAX FORWARD >
```



- Note:**
- When the Fax Forward feature is set, the abbreviated dialling number [00] will be restricted from editing the number. Please change this function to Invalid when you would like to edit the telephone number.
 - If the communication to transfer a received document(s) has failed, the received document(s) will be printed out and erased from memory even if the Fax Parameter No. 31 (INC. FILE SAVE) is set to valid. If you wish to save the document into memory in case of communication failure, set your machine to Receive To Memory. (see page 86)
 - It is not possible to receive a document if the memory of your machine overflows or is about 95% used.

File Transmission [For UF-770 only]



This feature allows your machine to store the document(s) into the File Transmission in order to send to multiple stations repeatedly. The document(s) in the File Transmission will be kept until erased.

Storing a Document(s)

To store the document(s), follow the steps below.

1  Set document(s) face down.

```
ENTER STATION(S)  
THEN PRESS START 00%
```

2  

```
FILE XMT MODE (1-4)  
ENTER NO. OR V ^
```

3 

```
1:STORE FILE?  
PRESS SET TO SELECT
```

4 

Your machine will start storing the document(s) into the memory.

```
* STORE *      NO.001  
      PAGES=01  01%
```

 **Note:** Only 1 file can be stored for File Transmission.

Sending the Stored Document(s)

To send the stored document(s), follow the steps below.

1

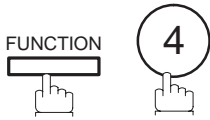

```
FILE XMT MODE (1-4)
ENTER NO. OR V ^
```

2

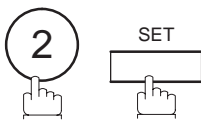

```
ENTER STATION(S)
THEN PRESS START
```

3

Dial by any combination of the following methods:

- Manual Number Dialling (Up to 32 stations)
 - One-Touch Dialling
 - Abbreviated Dialling
 - Directory Search Dialling
- (For details, see page 46 to 49.)

Ex:



```
<01>(Station name)
5551234
```

```
[10](Station name)
5553456
```

(When entering a station for Manual Number Dialling or Directory Search Dialling, press after each station is entered.)

4



```
* DIALLING * NO.001
5551234
```

Your machine starts to dial the telephone numbers in sequence.

File Transmission [For UF-770 only]

Deleting the Stored Document(s)

To delete the stored document(s), follow the steps below.

1

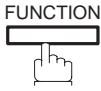

```
FILE XMT MODE (1-4)
ENTER NO. OR V ^
```

2



```
3:DELETE FILE?
PRESS SET TO SELECT
```

3

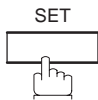

```
* DELETING *
```

Printing the Stored Document(s)

To print the stored document(s), follow the steps below.

1

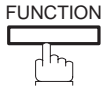

```
FILE XMT MODE (1-4)
ENTER NO. OR V ^
```

2



```
4:PRINT FILE?
PRESS SET TO SELECT
```

3



```
* PRINTING *
FILE XMT DOC
```

Your machine will print the file. The document(s) will remain in the memory even after printing the file.

5

Department Code [For UF-770 only]

General Description

This operation requires the user to input a preset 4-digit Department Code before transmission. The Department Name of the selected Department Code is printed on the Header of each page sent, Cover Sheet, COMM. Journal and Individual Transmission Journal. When the Department Code is set, the Transaction Journal will be sorted by the Department Code number (01 – 24) when it is printed.

If you wish to prevent unauthorized persons from setting, changing or erasing the Department Code settings, you should set the Fax Access Code to restrict these settings. (see page 84)

Setting the Department Code

1

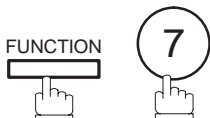

```
SET MODE      (1-6)
ENTER NO. OR V ^
```

2



```
FAX PARAMETER(01-99)
NO. = █
```

3



```
77 LOGO/DEPT. CODE
1:INVALID
```

4



```
77 LOGO/DEPT. CODE
3:DEPT. CODE
```

5



```
DEPT. CODE  (01-24)
ENTER NO. OR V ^
```

6

Enter Department Code number.

Ex: ①② (01 to 24)

```
LOGO/DEPT. NAME
12 █
```

Department Code [For UF-770 only]

7 Enter your Department Name (max. 25 characters and digits) by using character keys. (see page 10)

Ex: P A N A S O N I C SPACE
S A L E S (see Note)

LOGO/DEPT. NAME
12 PANASONIC SALES

8



INPUT DEPT. CODE
■■■■

5

9

Enter a 4-digit Department Code.

Ex: ①②③④

INPUT DEPT. CODE
1234

10

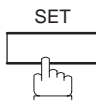

To record another Department Code, repeat step 6 to 10.
To return to standby, press **STOP**.

LOGO/DEPT. NAME
13

! **Note:** Use **COPY** to copy the default LOGO which is set in the User Parameters. You can add the department name following the default LOGO.

Department Code [For UF-770 only]

Changing or Erasing the Department Code

If you have to change or erase any of Department Code, follow the steps below.

1

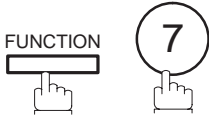

```
SET MODE      (1-6)
ENTER NO. OR V ^
```

2

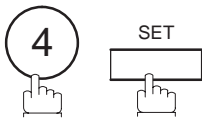

```
INPUT ACCESS CODE
■■■■
```

3

If you set the Fax Access Code to restrict the Fax Parameters settings, the unit prompts to Input Access Code. Input the Fax Access Code and press **SET**.

```
FAX PARAMETER(01-99)
NO. = ■
```

4



```
77 LOGO/DEPT. CODE
3:DEPT. CODE
```

5

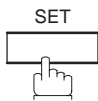

```
DEPT. CODE (01-24)
ENTER NO. OR V ^
```

6

Enter Dept. Code number you wish to change or erase.

Ex: ①② (01 to 24)

```
LOGO/DEPT. NAME
12 PANASONIC SALES
```

Department Code [For UF-770 only]

7

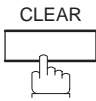

then enter a new LOGO. (see Note 1 and 2)

Ex: P A N A F A X SPACE
S A L E S

or just go to step 10 to erase the Department Code.

LOGO/DEPT. NAME
12 █

LOGO/DEPT. NAME
12 PANAFAX SALES █

8

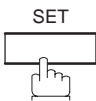

Enter a 4-digit Department Code.

Ex: (5) (6) (7) (8)

INPUT DEPT. CODE
1234

INPUT DEPT. CODE
5678

10



To change or erase another Department Code, repeat step 6 to 10. To return to standby, press **STOP**.

LOGO/DEPT. NAME
13 █



Note: 1. Use **<** **>** to move the cursor, then enter the correct Dept. Name over the old Dept. Name.

2. Use **COPY** to copy the default LOGO which is set in the User Parameters. You can add the department name following the default LOGO.

5

Department Code [For UF-770 only]

Sending Document with Department Code

1



Set document(s) face down.

```
ENTER STATION(S)  
THEN PRESS START 00%
```

2

Dial by any combination of the following methods:

- One-Touch Dialling
- Abbreviated Dialling
- Manual Number Dialling, press after each station is entered (Up to 32 stations)
- Directory Search Dialling, press after each station is entered
(For details, see page 46 to 49.)

Ex:

```
<01>(Station name)  
5551234
```

3

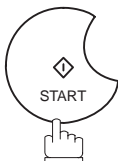

```
INPUT DEPT. CODE
```

4

Enter a 4-digit Department Code.

Ex: ①②③④

```
INPUT DEPT. CODE  
1234
```

5

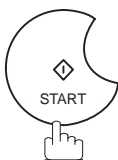

The document is sent with the header of the selected Department Name. The selected Department Name is printed on the COMM. Journal, Individual Transmission Journal and Cover Sheet.



Sending Document with Department Code (Voice Mode Transmission)

1



Set document(s) face down.

ENTER STATION(S)
THEN PRESS START 00%

2

Lift the fax handset or the external telephone or press **MONITOR**.

Ex: Press **MONITOR**

INPUT DEPT. CODE
■■■■

3

Enter a 4-digit Department Code.

Ex: ①②③④

INPUT DEPT. CODE
1234

4



* MONITOR *
■

5

Dial the telephone number from the keypad.

Ex: ⑤⑤⑤①②③④

* DIALLING *
5551234 ■

6

When you hear a beep,

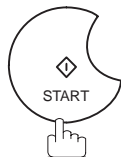

ON LINE * XMT *
5551234

The document is sent with the header of the selected Department Name. The selected Department Name is printed on the COMM. Journal, Individual Transmission Journal and Cover Sheet.

5

Department Code [For UF-770 only]

Printing a Department Code List

The Department Code List can be printed out following the Fax Parameter List.

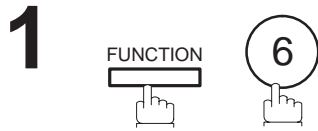

PRINT OUT (1-7)
ENTER NO. OR V ^



* PRINTING *
FAX PARAMETER LIST

Sample Department Code List (Prints following the Fax Parameter List)

```
***** -FAX PARAMETER LIST- ***** DATE 08-MAR-1997 ***** TIME 15:00 *** P.02
```

DEPARTMENT CODE LIST

(1) NUMBER	(2) DEPARTMENT NAME	(3) DEPARTMENT CODE
01	Panafax Sales	0001
02	Panafax Service	0002
03	Panafax Accounting	0003
)))
24	Panafax Engineering	0024

-PANASONIC -

```
***** -HEAD OFFICE - ***** 201 555 1212 - *****
```

Explanation of Contents

- (1) Department Code Number : 01-24
- (2) Department Name : Up to 25 characters
- (3) Department Code : 4 digits



Printing a Department Code Journal

When the Department Code is set, the transaction Journal will be sorted by the Department Code number when it is printed. All contents of the Journal will be erased automatically after being printed.

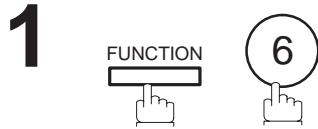

```
PRINT OUT      (1-7)
ENTER NO. OR  V ^
```



```
JOURNAL
1:PRINT 2:VIEW
```

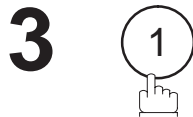

```
* PRINTING *
JOURNAL
```

5

Sample Department Code Journal / Originated Calls

```
***** -JOURNAL- ***** DATE 08-MAR-1997 ***** TIME 15:00 *** P.01

ORIGINATED CALLS
06-MAR TO 08-MAR (1)
(2) (3)
TOTAL PAGES = 000038 TOTAL TIME = 00:23'56

(4) (5)
01: Panafax Sales
-----
NO.  COM  PAGES  FILE  DURATION  X/R  IDENTIFICATION  DATE  TIME  DIAGNOSTIC
01   OK   005           00:05'13  XMT  5551234         06-MAR 15:10  C0044903C0000
21   OK   021/021  019   00:10'15  FWD  FAX FORWARD     06-MAR 18:10  C0044903C0000
(6) (7)
TOTAL PAGES = 000026 TOTAL TIME = 00:15'28

02: Panafax Service
-----
NO.  COM  PAGES  FILE  DURATION  X/R  IDENTIFICATION  DATE  TIME  DIAGNOSTIC
19   OK   001/001  017   00:00'13  XMT  5551234         07-MAR 10:10  C0044903C0000
30   OK   011/011  045   00:08'15  XMT  SERVICE DEPT.   07-MAR 13:10  C0044903C0000

TOTAL PAGES = 000012 TOTAL TIME = 00:08'28

***** -PANASONIC -
***** -HEAD OFFICE - ***** 201 555 1212 - *****
```

Department Code [For UF-770 only]

Sample Department Code Journal / Received Calls

```

***** -JOURNAL- ***** DATE 08-MAR-1997 ***** TIME 15:00 *** P.02

RECEIVED CALLS
06-MAR TO 08-MAR (1)
(2) (3)
TOTAL PAGES = 000011 TOTAL TIME = 00:13'41

NO. COM PAGES FILE DURATION X/R IDENTIFICATION DATE TIME DIAGNOSTIC
55 OK 005 00:05'13 RCV 4445678 06-MAR 12:10 C0044903C0000
56 OK 005/005 020 00:08'15 PLD 111 222 333 06-MAR 19:15 C0044903C0000

70 OK 001 017 00:00'13 RCV 44567345 07-MAR 10:10 C0044903C0000

-PANASONIC -
***** -HEAD OFFICE - ***** 201 555 1212 - *****

```

Explanation of Contents

- (1) Period date of this journal
- (2) Number of total pages transmitted/received for this machine.
- (3) Total transmitted/received time for this machine.
- (4) Department Code Number : 01-24
- (5) Department Name
- (6) Number of total pages transmitted/received for this department.
- (7) Total transmitted/received time for this department.



General Description

This operation allows the user to select one of the 25 preset LOGOs before a transmission. The selected LOGO is printed on the Header of each page sent, Cover Sheet, COMM. Journal and Individual Transmission Journal.

Setting the Multiple LOGO

- 1**

SET MODE (1-6)
 ENTER NO. OR V ^
- 2**

FAX PARAMETER(01-99)
 NO. = █
- 3**

77 LOGO/DEPT. CODE
 1:INVALID
- 4**

77 LOGO/DEPT. CODE
 2:MULTI-LOGO
- 5**

MULTI-LOGO (01-24)
 ENTER NO. OR V ^
- 6** Enter LOGO number.
Ex: ①② (01 to 24)

LOGO/DEPT. NAME
 12 █
- 7** Enter your LOGO (max. 25 characters and digits) by using character keys (see page 10).
Ex: P A N A S O N I C SPACE
 S A L E S (see Note)

LOGO/DEPT. NAME
 12 PANASONIC SALES █
- 8**

LOGO/DEPT. NAME
 13 █

To record another LOGO, repeat step 6 to 8. To return to standby, press .

5

! **Note:** Use to copy the default LOGO which is set in the User Parameters. You can add the department name following the default LOGO.

Multiple LOGO [For UF-770 only]

Changing or Erasing the Multiple LOGO

If you have to change or erase any of the Multiple LOGOs, follow the steps below.

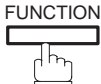
1  

SET MODE (1-6)
ENTER NO. OR V ^

2  

FAX PARAMETER(01-99)
NO. = █

3   

77 LOGO/DEPT. CODE
2: MULTI-LOGO

4 

MULTI-LOGO (01-24)
ENTER NO. OR V ^

5 Enter LOGO number you wish to change or erase.
Ex: ①② (01 to 24)

LOGO/DEPT. NAME
12 PANASONIC SALES

6 

LOGO/DEPT. NAME
12

then enter a new LOGO (see Note 1 and 2).

Ex: P A N A F A X SPACE
S A L E S

or just go to step 7 to erase the LOGO.

7 

LOGO/DEPT. NAME
13 █

To return to standby, press **STOP**.

- !** **Note:** 1. Use **<** **>** to move the cursor, then enter the correct LOGO over the old LOGO.
2. Use **COPY** to copy the default LOGO which is set in the User Parameters. You can add the department name following the default LOGO.



Sending Document with Multiple LOGO

1



Set document(s) face down.

```
ENTER STATION(S)
THEN PRESS START 00%
```

2

Dial by any combination of the following methods:

- One-Touch Dialling
- Abbreviated Dialling
- Manual Number Dialling, press after each station is entered (Up to 32 stations)
- Directory Search Dialling, press after each station is entered
(For details, see page 46 to 49.)

Ex:

```
<01>(Station name)
5551234
```

3



```
SELECT LOGO (01-24)
ENTER NO. OR V ^
```

4

Enter LOGO No. or use or to select the LOGO that you want to use. (see Note 2)

Ex: ① ②

```
12 PANASONIC SALES
```

5

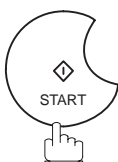

The document is sent with the header of the selected LOGO. The selected LOGO is printed on the COMM. Journal, Individual Transmission Journal and Cover Sheet.



- Note:**
1. The Multiple LOGO function cannot be used in the Voice Dialling Mode.
 2. If you skip selecting the LOGO in the step 4, the unit selects the default LOGO (00) which is set by the User Parameters.

5

Multiple LOGO [For UF-770 only]

Printing a Multiple Logo List

The Multiple Logo List can be printed out following the Fax Parameter List.

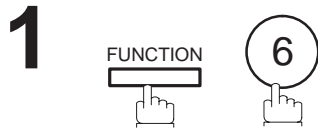

PRINT OUT (1-7)
ENTER NO. OR V ^



* PRINTING *
FAX PARAMETER LIST

Sample Multiple LOGO List (Prints following the Fax Parameter List)

```
***** -FAX PARAMETER LIST- ***** DATE 08-MAR-1997 ***** TIME 15:00 *** P.02

MULTI-LOGO LIST

(1)      (2)
NUMBER   LOGO

  01      Panafax Sales
  02      Panafax Service
  03      Panafax Accounting
  )
  24      Panafax Engineering

                                     -PANASONIC -
***** -HEAD OFFICE - ***** - 201 555 1212 - *****
```

Explanation of Contents







- (1) LOGO Number : 01-24
- (2) Multiple LOGO : Up to 25 characters

Selective Reception ◀

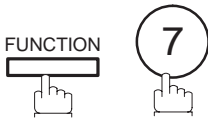
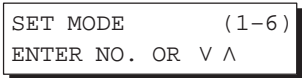
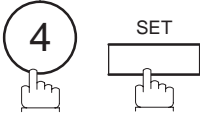
Your machine has a special feature, Selective Reception, which can prevent the receiving of unnecessary documents (i.e. junk fax, direct mail, etc.).

Before receiving the document, the last 4 digits of the ID Number received from the sending machine will be compared with the last 4 digits of the telephone number programmed in each One-Touch or Abbreviated station. When a match is found, your machine will start receiving the document. If a match is not found, your machine will cancel the reception and an Information Code 406 will be recorded on the Journal.

Setting the Selective Reception

- 1**  
- 2**  
- 3**  
- 4**  
- 5** 

- !** **Note:** 1. When the Selective Reception is set, your machine can receive from only those stations which are programmed in the built-in auto-dialer.
2. If your ID number has not been set, your machine might not be able to receive from some models. To set your ID number, see page 28.

0000 Password Communications

General Description

Password Communications, including Password Transmission and Password Reception will prevent your machine from sending a fax to a wrong station or receiving a fax from unauthorized stations. You can set Password Transmission and Password Reception independently, or both together.

To use Password Transmission, you must set a 4-digit transmission password in advance. The password must be shared with other compatible Panafax machine(s). If the transmission password in your machine does not match the transmission password in the other compatible Panafax machine(s), the transmission will fail. You can select password transmission by setting Function 8-4, PASSWORD-XMT to **ON** when you send a document.

To use Password Reception, you must set a 4-digit receiving password in advance. The password must be shared with the other compatible Panafax machine(s). If the password in your machine does not match the receiving password in the other compatible Panafax machine(s), the reception will fail. Once you set password reception and set the parameter to **ON**, it stays until you change the setting to **OFF**.

Compatibility with Other Machines

You can only use password transmission and reception with another Panafax compatible machine(s) listed below.

Model	Special Settings
UF-160	
UF-160M	
UF-170	
UF-260	
UF-270	
UF-270M	
UF-280M	
UF-300	
UF-312	
UF-322	
UF-342	
UF-550	Required.
UF-560	Please refer to the individual User's Guide of each model.
UF-650	
UF-733	
UF-744	
UF-745	
UF-750	
UF-750D	
UF-755	
UF-766	
UF-770	
UF-788	
UF-M500	

Setting Password Transmission





To set transmission password and parameter,

1   

2   

3    

4 Enter a 4-digit Transmission Password.

Ex:     and press 

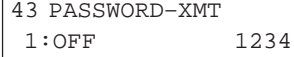

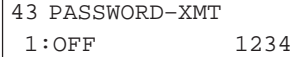

5  for OFF (password is not checked)
or

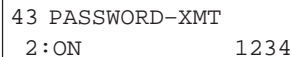

 for ON (password is checked)



6  

 **Note:** 1. You can change the setting temporarily by using FUNCTION 8-4 (PASSWORD-XMT) for each transmission. See page 115 for details.

2. To change the password, press  in step 4. Then re-enter the new one.

Password Communications

Setting Password Reception

To set receiving password and parameter,

1  

SET MODE (1-6)
 ENTER NO. OR V ^

2  

FAX PARAMETER(01-99)
 NO. = █

3   

44 PASSWORD-RCV ■■■■



4 Enter a 4-digit Receiving Password.
 Ex: ①②③④ and press 

44 PASSWORD-RCV
 1: OFF 1234

5  for OFF (password is not checked)
 or

 for ON (password is checked)

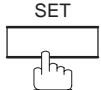
44 PASSWORD-RCV
 2: ON 1234

6  

- !** **Note:** 1. Once you set the parameter, you cannot select the parameter, **OFF** or **ON**, for each reception. It is always **OFF** or **ON** until you change the setting.
 2. To change the password, press  in step 4. Then re-enter the new one.

Password Communications

Using Password Transmission

To use Password Transmission, you can select PASSWORD-XMT OFF or ON for each Transmission by following the procedure below.

1  Set document(s) face down.

```
ENTER STATION(S)
THEN PRESS START 00%
```

2  

```
SELECT MODE (1-5)
ENTER NO. OR V ^
```

3  

```
PASSWD-XMT=OFF
1:OFF 2:ON
```

4  for OFF (password is not checked)
or

```
PASSWD-XMT=OFF
1:OFF 2:ON
```

 for ON (password is checked)

```
PASSWD-XMT=ON
1:OFF 2:ON
```

5 

```
ENTER STATION
THEN PRESS START
```

- 6** Dial by any combination of the following methods:
- One-Touch Dialling
 - Abbreviated Dialling
 - Manual Number Dialling, press after each station is entered (UF-770: Up to 32 stations, UF-550/560: Up to 12 stations)
 - Directory Search Dialling, press after each station is entered (For details, see page 46 to 49.)

Ex:

Continued on the next page.

▶ Password Communications

7

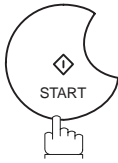

If your machine's Transmission Password coincides with the other station's Transmission Password, your machine starts sending the document.

When transmission is completed, PASSWORD-XMT returns to standard setting (**OFF** or **ON**).

Using Password Reception

There is no additional operation required once you set the parameter following the procedure on the previous page. The parameter, **OFF** or **ON**, cannot be selected for each reception. It is always **OFF** or **ON** until you change the setting.

Confidential Mailbox and Confidential Network Communications

Your machine is equipped with two Confidential Communication features which ensure that the Confidential information you send is received by only the person with the correct confidential code.

Confidential Mailbox

The confidential mailbox feature can be used as a mailbox to communicate with other compatible models using a 4-digit confidential code. The Confidential Mailbox feature receives document(s) with a confidential code into memory. These documents can only be printed by the person who has the correct confidential code.

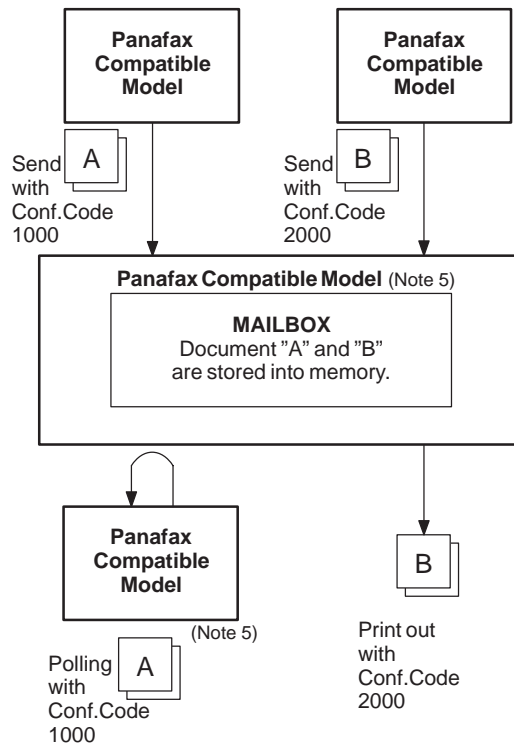

Figure 1: Confidential Mailbox

Compatibility with Other Machines

Table 1 shows a list of compatible Panafax model which has the Confidential Mailbox feature. It also shows whether or not special settings are required.

Table 1: Confidential Mailbox Requirement

Compatible Model					Special Settings
UF-280M	UF-342	UF-733	UF-755	UF-788	Not Required.
UF-312	UF-550	UF-744	UF-766		
UF-322	UF-560	UF-745	UF-770		



- Note:**
1. If your machine receives two confidential faxes with same confidential code, both documents are stored together in the same confidential mailbox.
 2. Up to 10* Mailbox files can be stored in memory. So, you can receive the confidential fax using 10* different confidential codes. (*UF-550/560 : Up to 7 Mailbox files)
 3. If the memory overflows, the machine will stop receiving and release the line.
 4. We recommend that optional memory be installed when this function is used. See page 166 for Image Memory Capacity.
 5. If a confidential faxes was received in the mailbox of UF-733, you cannot poll those document. The UF-733 is designed to print out the received confidential document locally only.

Confidential Mailbox and Confidential Network Communications

Sending a Confidential Document to a Remote Station's Mailbox

1



Set document(s) face down.

ENTER STATION(S)
THEN PRESS START 00%

2

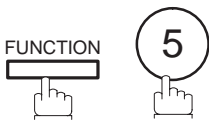

CONF. COMM. (1-5)
ENTER NO. OR V Λ

3

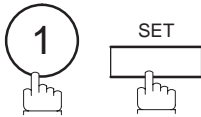

CONFIDENTIAL XMT
CONF. CODE=■■■■

4

Enter a 4-digit Confidential Code.

Ex: ②②③③

CONFIDENTIAL XMT
CONF. CODE=2233

5

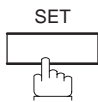

ENTER STATION
THEN PRESS START

6

Dial by any one of the following methods:

- One-Touch Dialling
- Abbreviated Dialling
- Manual Number Dialling
- Directory Search Dialling

Ex: 01

<01>(Station name)
5551234

7

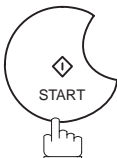

If necessary, inform the receiving person and tell them the Confidential Code.



Note: If the receiving station has a Network Password, you must set the same password, shared by the receiving station, to send confidential fax. (see page 126 and 127)

Confidential Mailbox and Confidential Network Communications

Polling a Confidential Document from a Remote Station's Mailbox

After you have been informed that someone has transmitted a confidential document to a remote station's mailbox, you can poll the confidential document from the remote station in the following way.

1   

2   

3 Enter a 4-digit Confidential Code.
Ex:    

4  

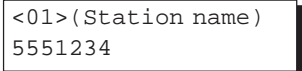
5 Dial by any one of the following methods:
• One-Touch Dialling
• Abbreviated Dialling
• Manual Number Dialling
• Directory Search Dialling
Ex:  

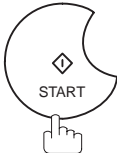
6 

 **Note:** The confidential file will be erased automatically at the center station after being polled.

Confidential Mailbox and Confidential Network Communications

Receiving a Confidential Document to Your Machine's Mailbox

No special setting is required, your machine comes with this feature ready to use. Your machine receives a confidential fax the same way it receives a normal fax message. When receiving the confidential fax, the display shows the following message and prints out CONF. RCV REPORT.

MESSAGE IN MAIL BOX

Sample CONF. RCV Report

```
***** -CONF.RCV REPORT- ***** DATE 08-MAR-1997 ***** TIME 12:00 *****P.01

      ** NOTICE OF CONFIDENTIAL DOCUMENT HELD **

(1)      (2)      (3)      (4)
FILE NO. RECEIVED FROM      PAGES      TIME RECEIVED

      040      PANAFAX      001      08-MAR 12:00

                                  -PANASONIC      -

***** -HEAD OFFICE      -***** -      201 555 1212- *****
```

Explanation of Contents

- (1) File number :001 to 255
- (2) Received remote station's ID :Character ID or Numeric ID
- (3) Number of pages received
- (4) Received time



- Note:**
1. If your machine receives two confidential faxes with same confidential code, both documents are stored together in the same confidential mailbox.
 2. Up to 10* Mailbox files can be stored in memory. So, you can receive the confidential fax using 10* different confidential codes. (*UF-550/560 : Up to 7 Mailbox files)
 3. If the memory overflows, the machine will stop receiving and release the line.
 4. You can verify whether the unit has received a confidential fax by printing out the File List (see page 76).

Confidential Mailbox and Confidential Network Communications

Storing a Confidential Document in Your Machine's Mailbox

Use the following procedure to store a document in a confidential mailbox in your machine. Once the confidential document is stored in your machine, it can be polled by the other machine.

1



Set document(s) face down.

```
ENTER STATION(S)  
THEN PRESS START 00%
```

2

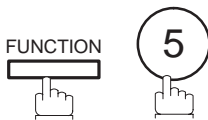

```
CONF. COMM. (1-5)  
ENTER NO. OR V ^
```

3

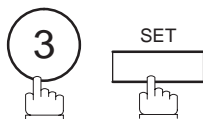

```
CONFIDENTIAL POLLED  
CONF. CODE=■■■■
```

4

Enter a 4-digit Confidential Code.

Ex: ②②③③

```
CONFIDENTIAL POLLED  
CONF. CODE=2233
```

5

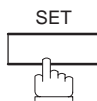

The document will be stored into memory.
If necessary, inform the receiving party of the confidential document and tell them the confidential code needed to poll the document.

```
* STORE * NO.002  
PAGES=01 01%
```



Note: The confidential file will be erased automatically after being polled.
If you wish to retain the confidential file even after being polled, change the setting of Fax Parameter No. 42 (CONF. POLLED FILE SAVE) to "Valid".

6

Confidential Mailbox and Confidential Network Communications

Printing Out a Confidential Document from Your Machine's Mailbox

After you have been notified that someone has transmitted a confidential document to your machine's mailbox, use the following procedure to print out the confidential document.

1

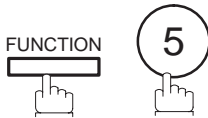

```
CONF. COMM. (1-5)
ENTER NO. OR V ^
```

2

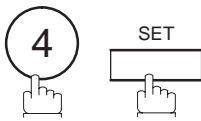

```
PRINT CONF. FILE
CONF. CODE=■■■■
```

3

Enter Confidential Code of the document you want to print out.

Ex: ②②③③

```
PRINT CONF. FILE
CONF. CODE=2233
```

4



The machine will print out the confidential documents.

```
* PRINTING *
PAGE=001/001
```







Note: The confidential file will be erased automatically after being printed out even if the setting of Fax Parameter No. 42 (CONF. POLLED FILE SAVE) is changed to "Valid".





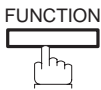

Deleting a Confidential Document Stored in Your Machine's Mailbox

If your memory becomes full, or you just want to clean out your confidential document, you may delete one or more confidential fax stored in your machine using the following procedure. There are two type of confidential file deletion, one is to delete file by Confidential Code, and others is to delete all confidential files in memory.

To delete file using Confidential Code

<p>1</p>  	CONF. COMM. (1-5) ENTER NO. OR V ^
<p>2</p>  	DELETE CONF. FILE CONF. CODE= █ █ █ █
<p>3</p> <p>Enter a 4-digit Confidential Code.</p> <p>Ex: ②②③③</p>	DELETE CONF. FILE CONF. CODE=2233
<p>4</p> 	* DELETING * CONF. CODE=2233

To delete all confidential file in memory

<p>1</p>  	CONF. COMM. (1-5) ENTER NO. OR V ^
<p>2</p>  	DELETE CONF. FILE CONF. CODE= █ █ █ █
<p>3</p> 	DELETE ALL CONF. FILES? 1: YES 2: NO
<p>4</p> 	* DELETING * ALL CONF. FILES

Confidential Network Communications (Via a Center Station)

The Confidential Network Communication requires a Center Station such as a UF-650 to communicate with other Panafax models which have confidential communication features. First the Initial Sending Station sends a confidential document to the Center Station together with a Confidential Code. The document will remain in the center station's memory until polled by End Receiving Station. In the example given in figure 2, the End Receiving Station must know the Confidential code attached to the document.

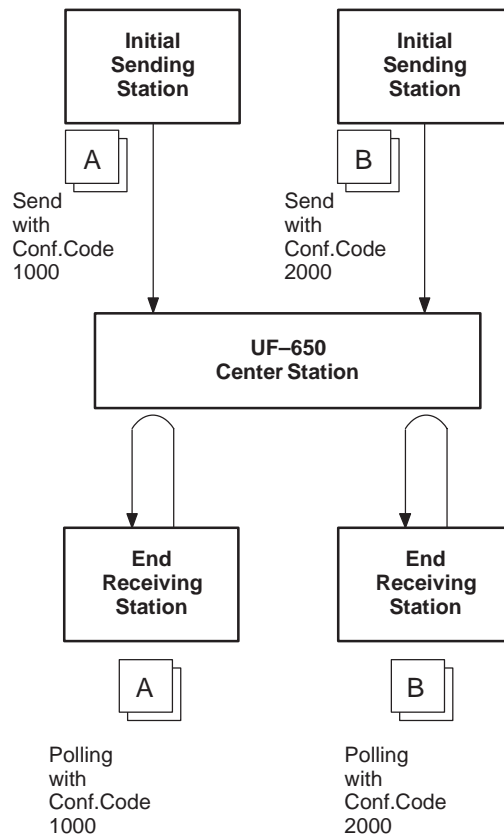

Figure 2: Sending Confidential Faxes via Center Station

If a UF-650 or UF-620 is the Center Station, more than one document can be stored in the same memory file using the same Confidential Code. That is, you can keep adding faxes to the file, just like putting mail in a mailbox, until the memory is full. If a UF-640 is the Center Station, you cannot add a fax to the file which has the same Confidential Code attached with a file already stored in the memory. Whichever station you use, you can create more than one file, each with a different Confidential Code.

The stored confidential document will be available to be polled by the end receiving station.

Once you have polled or printed the confidential document from the Center Station, the document is automatically erased from the Center Station's memory.

Compatibility with Other Machines

Table 1 shows how your machine fits in with the compatibility requirements of the different kinds of facsimile stations which make up a Network for Confidential Communications. It also shows whether or not special settings are required.

Table 1: Confidential Communication Requirement

Station	Compatible Model	Special Settings
Initial Sending Station	Panafax 145, Panafax 155, UF-140, UF-150, UF-160, UF-160M, UF-170, PD-170E, UF-250, UF-260, UF-270, UF-270M, UF-280M, UF-300, UF-312, UF-322, UF-342, UF-550, UF-560, UF-620, UF-640, UF-650, UF-733, UF-744, UF-745, UF-750, UF-750D, UF-755, UF-766, UF-770, UF-788	Required. Please refer to the individual User's Guides of each machine.
Confidential Center Station	UF-620, UF-640, UF-650	
End Receiving Station	Panafax 145, Panafax 155, UF-140, UF-150, UF-160, UF-160M, UF-170, PD-170E, UF-250, UF-260, UF-270, UF-270M, UF-280M, UF-300, UF-312, UF-322, UF-342, UF-550, UF-560, UF-620, UF-640, UF-650, UF-733, UF-744, UF-745, UF-750, UF-750D, UF-755, UF-766, UF-770, UF-788	

Setting Up Your Machine for Confidential Network Communications

To use Confidential Communications, you must first preset the Confidential Communication Fax Parameter described below. Then, every time you actually send a Confidential Fax you must set a Confidential Code.

1. Confidential Communication Fax Parameter

This switches the Confidential Communications function to Invalid/Valid.

2. Own Telephone Number

The full telephone number should be entered.

3. Network Password and Polling Password

You may use Network Password and Polling Password to prevent outside facsimile(s) from using the Confidential Communication network. The same password must be provided to all the machines inside the network.

4. Confidential Code

A 4-digit code must be assigned to each Confidential Fax you send. It identifies the fax when it is stored in the Relay Station. The receiving person must know the code in order to poll the fax from the Relay Station.

Confidential Mailbox and Confidential Network Communications



To set the Fax Parameter for Confidential Network Communication

1   

2   

3    

4  

5  

Confidential Mailbox and Confidential Network Communications

To set your own Telephone Number and Network Password

1

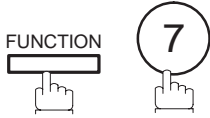

SET MODE (1-6)
ENTER NO. OR V ^

2

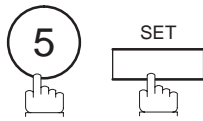

OWN TELEPHONE NO.

3

Enter your telephone number (max. 36 digits).

Ex: ① SPACE ② ① ② SPACE
① ① ① SPACE ① ② ③ ④

OWN TELEPHONE NO.
1 212 111 1234

4

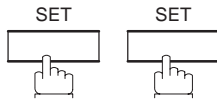

NETWORK PASSWORD

5

Enter a 4-digit Network Password.

Ex: ⑨ ⑨ ⑨ ⑨

NETWORK PASSWORD
9999

6

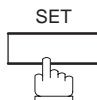

OWN TELEPHONE NO.
1 212 111 1234

7



6

Relayed Transmission

General Description

Relayed Transmission is a feature which can save you time and transmission costs if you need to send the same document to several facsimile stations at the same time. This is especially true if the transmissions are long distance.

To use Relayed Transmission, you must be part of a "Relay Network" built around a "Relay Station". That is, when you send a document by Relayed Transmission, you actually send it to a Relay Station together with instructions to relay it to one or more end receiving station(s).

The Relay Station first receives the document in its memory and then relays it to the end receiving station(s).

Example:

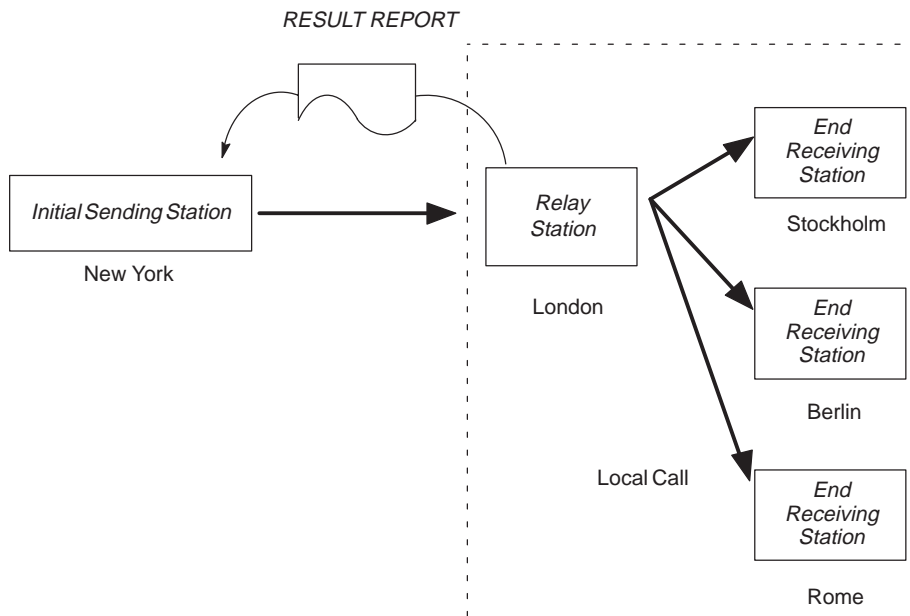

Compatibility with Other Machines

Table 1 shows the kind of facsimile machines which can make up a Relay Network used for Relayed Transmission. Note that your machine can serve as an Initial Sending Station or End Receiving Station.

Table 1: Relay Network Compatibility Requirements

Station	Compatible Model				Special Settings
Initial Sending Station	UF-150	UF-312	UF-745		Required. Please refer to the individual User's Guides of each machine.
	UF-160	UF-322	UF-750		
	UF-160M	UF-342	UF-750D		
	UF-170	UF-550	UF-755		
	UF-250	UF-560	UF-766		
	UF-260	UF-620	UF-770		
	UF-270	UF-640	UF-788		
	UF-270M	UF-650			
	UF-280M	UF-733			
	UF-300	UF-744			
Relay Station	UF-620	UF-650	UF-640	UF-M500	
End Receiving Station	ITU-T/CCITT G3 Compatible machines				Not required.

Relay Network

A Relay Network is basically a group of facsimiles programmed to communicate with each other via a Relay Station. In this case, the word programmed means that certain numbers have been stored in the memory of each machine. These numbers, also called parameters, are needed to identify the machines in the network.

Since your machine can only serve as an Initial Sending Station or End Receiving Station in a Relay Network, it is assumed that you will not have to establish the network yourself. All you have to do is follow the set up procedure described here, and certain instructions provided by the network organizer (usually the person controlling the Relay Station). You should know, however, what kind of network you are going to connect to, and how it works. A sample network is shown in figure 1.

Figure 1 shows a sample network as seen from New York. London and Singapore are Relay Stations connected to New York. Viewed from New York, Stockholm, Berlin, Rome, Tokyo, Hong Kong, Wellington and Sydney are End Receiving Stations.

With this simple network using two Relay Stations, you can send a document with one operation to any combination of stations in the network via the London Relay Station and/or Singapore Relay Station. If New York only transmits to one station, for example, then the document will go directly to the station or indirectly via the Relay Station depending on the One Station XMT Parameter you preset.

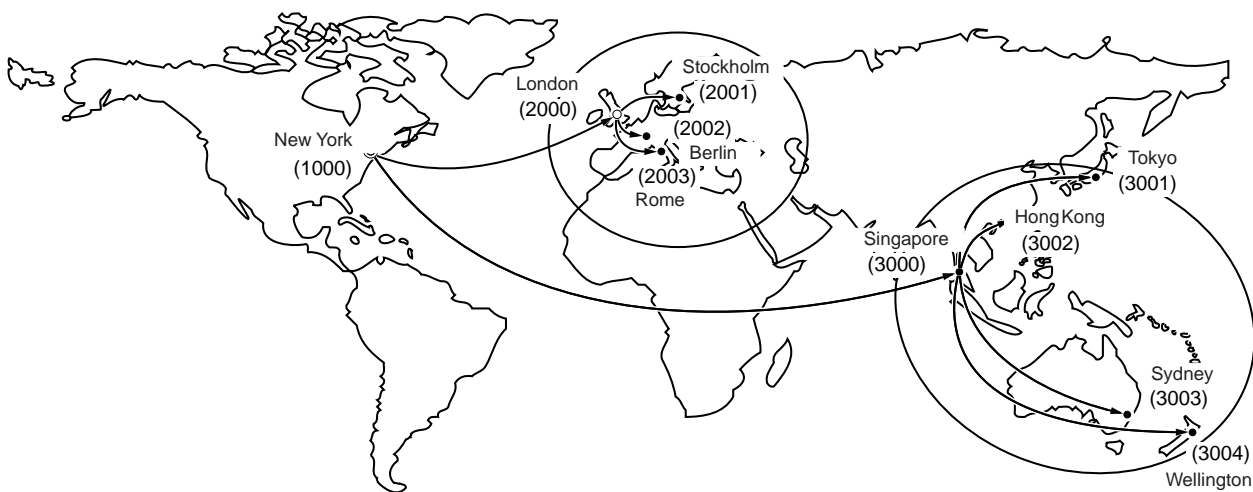

Figure 1: Sample Network

Relayed Transmission

Table 2, 3 and 4 are sample settings for a Sample Network.

Table 2: Sample Parameter and Abbreviated Dialling Number Table for New York

Telephone Number : 212 111 1234
 Network Address : 1000
 Relay Address : 10

One-Touch/ ABBR No.	Station Name	Telephone Number	Relay Address	Relay Station Yes/No	Network Address	One Station XMT
01	London	44 71 111 1234	20	Yes	2000	Direct
02	Stockholm	46 8 111 1234	20	No	2001	Direct
03	Berlin	49 611 111 1234	20	No	2002	Direct
04	Rome	39 6 111 1234	20	No	2003	Direct
05	Singapore	65 111 1234	30	Yes	3000	Direct
06	Tokyo	81 33 111 1234	30	No	3001	Direct
07	Hong Kong	852 4 111 1234	30	No	3002	Direct
08	Sydney	61 2 111 1234	30	No	3003	Direct
09	Wellington	64 4 111 1234	30	No	3004	Direct

Table 3: Sample Parameter and Abbreviated Dialling Number Table for London

Telephone Number : 71 111 1234
 Network Address : 2000
 Relay Address : 20

One-Touch/ ABBR No.	Station Name	Telephone Number	Relay Address	Relay Station Yes/No	Network Address	One Station XMT
01	Stockholm	46 8 111 1234	20	No	2001	Direct
02	Berlin	49 611 111 1234	20	No	2002	Direct
03	Rome	39 6 111 1234	20	No	2003	Direct
04	New York	1 212 111 1234	10	No	1000	Direct
05	Singapore	65 111 1234	30	Yes	3000	Direct
06	Tokyo	81 33 111 1234	30	No	3001	Direct
07	Hong Kong	852 4 111 1234	30	No	3002	Direct
08	Sydney	61 2 111 1234	30	No	3003	Direct
09	Wellington	64 4 111 1234	30	No	3004	Direct

Table 4: Sample Parameter and Abbreviated Dialling Number Table for Singapore

Telephone Number : 65 111 1234
 Network Address : 3000
 Relay Address : 30

One-Touch/ ABBR No.	Station Name	Telephone Number	Relay Address	Relay Station Yes/No	Network Address	One Station XMT
01	New York	1 212 111 1234	10	No	1000	Direct
02	London	44 71 111 1234	20	Yes	2000	Direct
03	Stockholm	46 8 111 1234	20	No	2001	Direct
04	Berlin	49 611 111 1234	20	No	2002	Direct
05	Rome	39 6 111 1234	20	No	2003	Direct
06	Tokyo	81 33 111 1234	30	No	3001	Direct
07	Hong Kong	852 4 111 1234	30	No	3002	Direct
08	Sydney	61 2 111 1234	30	No	3003	Direct
09	Wellington	64 4 111 1234	30	No	3004	Direct

Setting Up Your Machine for Relayed Transmission

To set up your machine for Relayed Transmission, use the procedures on the following pages to set the parameters listed below. Some parameters (e.g., Relayed XMT FAX Parameter) are only set once, but others must be set separately for each station in the Relay Network.

1. Relayed XMT Request FAX Parameter

This switches the Relayed XMT Request function to Valid or Invalid.

2. Own Telephone Number

The full telephone number to which the machine is connected should be entered for Relay Station send back Result Report.

3. Own Network Address

A 4-digit Own Network Address should be entered for Relay Station send back Result Report.

4. Network Password

A 4-digit number which prevents unauthorized (outside) stations from accessing the Relay Station and using its memory. Every Relay requesting and Relay stations in the network should set the same Network Password.

5. One-Touch/ABBR Numbers

The One-Touch or ABBR number you set must represent the fax number of a particular station in the network as seen from your station.

1) Network Address

End Receiving Station telephone numbers set in an Initial Sending Station may be different from the numbers set in a Relay Station. To send a fax to an End Receiving Station via a Relay Station each station in the network must be identified with a certain code which does not vary depending on where you call from. The code is the Network Address, which consists of a 4-digit number and is assigned to a One-Touch/ABBR number.

2) Relay Address

A 2-digit number which identifies the Relay Station your machine will use. Your machine may be connected to more than one Relay Station in parallel, but when you use Relayed XMT Request your machine will only send documents to the Relay Station identified by the Relay Address.

3) Relay Station Parameter (Yes/No)

Set "**Yes**" if the particular station you are recording is a Relay Station. If you are connected to more than one Relay Station in series, set "**Yes**" only for the first Relay Station.

4) One Station XMT (Relay/Direct) Parameter



If you send a document to only one End Receiving Station, you can set your machine to transmit directly to that station, without going through the Relay Station, by selecting "**No**". Set "**Yes**" if you always want to go through the Relay Station.

Relayed Transmission



To set the Relayed XMT FAX Parameters;

- 1**  



SET MODE (1-6)
 ENTER NO. OR V ^
- 2**  

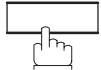

FAX PARAMETER(01-99)
 NO. = █
- 3**   

40 RELAY XMT REQUEST
 1:INVALID
- 4** 

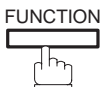





40 RELAY XMT REQUEST
 2:VALID
- 5**  









To set your own Telephone Number, own Network Address and Network Password;

- 1**  

SET MODE (1-6)
 ENTER NO. OR V ^
- 2**  

OWN TELEPHONE NO.
 █
- 3** Enter your telephone number (max. 36 digits).

Ex:      

and press 

OWN NETWORK ADDRESS
 █ █ █ █

Continued on the next page.

Relayed Transmission

4 Enter your 4-digit Network Address.

Ex: ①①①① and press

NETWORK PASSWORD
■■■■

5 Enter your 4-digit Network Password.

Ex: ⑨⑨⑨⑨ and press

OWN TELEPHONE NO.
1 212 111 1234

6 

6

To set a One-Touch/ABBR. Dialling Number, Network Address, Relay Station Parameter (Yes/No) and One Station XMT (Relay/Direct) Parameter;

1 

SET MODE (1-6)
ENTER NO. OR V ^

2 

1: ONE-TOUCH
2: ABBR. NO.

3 

ONE-TOUCH< >
PRESS ONE-TCH OR V ^

4 Ex:

<01>
ENTER TEL. NO.

Continued on the next page.

Relayed Transmission

5 Enter the telephone number.

Ex: ⑨ PAUSE ⑤⑤⑤ SPACE
①②③④ and press SET

```
<01> ENTER NAME
9-555 1234
```

6 Enter the station name.

Ex: S A L E S SPACE D E P T
and press SET

```
<01> NETWORK ADDRESS
||||
```

7 Enter a 4-digit Network Address.

Ex: ②①①① and press SET

```
<01> RELAY ADDRESS
||
```

8 Enter a 2-digit Relay Address.

Ex: ②① and press SET

```
<01> RELAY STN? 2
1: YES 2: NO
```

9 If the recorded station is the Relay Station, press ①.
If not, press ②.

Ex: ①

10 In case the station you have just recorded will be used for one-station transmission, you can preset the transmission route.

1: For transmission via the Relay Station
2: For direct transmission

Ex: ②

```
ONE-TOUCH< >
PRESS ONE-TCH OR V ^
```

Repeat step 4 through 10 to enter the numbers for other stations, or return to standby by pressing STOP.

Print out a list of One-Touch/ABBR number or Directory Search List to confirm that you have recorded everything correctly. For the printout operation, refer to page 147.

Sending a Document by Relayed Transmission

Once you have recorded all the necessary parameters in your machine in accordance with the Relay Network you belong to, you can send a document to two or more stations in the network system, automatically, using the procedure below.

1



Set document(s) face down.

```
ENTER STATION(S)  
THEN PRESS START 00%
```

2

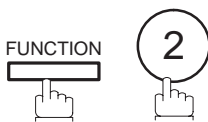

```
ENTER STATION(S)  
THEN PRESS START
```

3

Dial by any combination of the following methods:

- One-Touch Dialling
- Abbreviated Dialling
- Directory Search Dialling, press after each station is entered
(For details, see page 46 to 49.)

Ex:

```
<01>(Station name)  
5551234
```

4



The document is stored into memory and your machine starts to dial the number of the Relay Station and sends the document.

```
* STORE *      NO.001  
PAGES=01  01%
```

After the Relay Station finishes its transmission to the End Receiving Stations, your machine prints out a RELAY XMT RESULT REPORT sent back by the Relay Station.



Note: You cannot use manual number dialling in step 3.

Relayed Transmission

Printouts and Reports

When you use Relayed Transmission, your machine will print the following two reports to help you check and keep track of your faxes.

1. Relay XMT Report (COMM. JOURNAL)

When your machine finishes transmitting to the Relay Station, it will print a COMM. Journal when the Fax Parameter No. 12 is set to "2", this tells you whether the transmission was successful or not.

2. Result Report

When the Relay Station finishes transmitting your fax document to the End Receiving Station(s) in your network, it will print a RELAY XMT RESULT REPORT, it tells you what it did and whether it was successful or not.

Sample Relay XMT Report (COMM. JOURNAL)

```

***** -COMM.JOURNAL - ***** DATE 08-MAR-1997 **** TIME 15:00 **** P.01

(1)
MODE = MEMORY RELAYED TRANSMISSION          (2)
START= 08-MAR 14:50                          (3)
END= 08-MAR 15:00

FILE NO.= 050 (4)

(5)      (6)  (7)      (8)      (9)      (10)      (11)
STN NO.  COM  ABBR NO.  STATION NAME/TEL NO.  PAGES      DURATION  RLY STN

001      R-OK <01>/2000  LONDON          001/001      00:01'30  <01>/2000
002      R-OK <02>/2001  STOCKHOLM      001/001      RELAY      <01>/2000
003      R-OK <03>/2002  BERLIN          001/001      RELAY      <01>/2000
004      R-OK <04>/2003  ROME            001/001      RELAY      <01>/2000

***** - PANASONIC -
***** - HEAD OFFICE - ***** - 201 555 1212 - *****

```

- (1) Indication of communication mode
- (2) Start time of communication
- (3) End time of communication
- (4) File number : 001 to 255
- (5) Sequential number of the stations :
- (6) Communication result : "R-OK" indicates that the Relayed XMT Request was successful. 3-digit Info Code (see page 155) indicates that the communication has failed. In this case, the machine will print out the attached report with first page of your document as shown on page 145.
- (7) Abbreviated number and Network Address
- (8) Recorded name in One-touch or ABBR Number Dialling
- (9) Number of pages transmitted : 3-digit number is the number of pages successfully transmitted.
- (10) Duration of communication : The communication that was requested to be transferred via the relay station is shown as "RELAY".
- (11) Relay station's ABBR. NO. / Network Address

! **Note:** If you transmit through more than one Relay Station, you will receive a separate Result Report.

Sample Result Report (Relay XMT Result)

```

(1)
08-MAR-1997 12:10 FROM LONDON TO NEW YORK P.001/001

***** -RESULT REPORT- ***** DATE 08-MAR-1997 ***** TIME 12:10 ***** P.1
(2)
MODE = RELAYED TRANSMISSION
(3) (6) (7)
REQUEST REC'V TIME=08-MAR 11:40 START=08-MAR 12:00 END=08-MAR 12:10
NUMBER OF PAGE(S) = 01 (4)
FILE NO. = 045 (5)

**** REQUESTING STATION ** (8)
- NEW YORK -
TELEPHONE NUMBER = 212 111 1234
NETWORK ADDRESS = 1000

(9) (10) (11) (12) (13)
NO. COM DESTINATION(S) PAGE(S) RLY STN

01 OK 2000 LONDON 001/001
02 OK 2001 STOCKHOLM 001/001
03 OK 2002 BERLIN 001/001
04 INC 2003 ROME 000/001

**RELAY STATION ** (14)
- LONDON -
TELEPHONE NUMBER = 44 71 111 1234
RELAY ADDRESS= 20
NETWORK ADDRESS= 2000

- LONDON -
***** - 44 71 111 1234 - *****
TOTAL P.01
    
```

Explanation of Contents

- (1) Relay Station's Header Print
- (2) Indication of transmission mode
- (3) The time when the relay request was received
- (4) Number of pages received relay request
- (5) File number of the received relay request file
- (6) The time when the Relay Station starts sending Relay Faxes
- (7) The time when the Relay Station ends sending Relay Faxes
- (8) Initial Sending Station's information (LOGO, Telephone number and Network Address)
- (9) Communication number
- (10) Communication result : "OK" indicates that the transmission was successful.
"R-OK" indicates that the transmission to the Relay Station was successful.
"INC" indicates that the transmission was not completed.
- (11) Station name
- (12) Number of pages transmitted/number of pages received Relay Request
- (13) Another Relay Station's Relay Address/Network Address (If transferred to another Relay Station)
- (14) Relay Station's information (LOGO, Telephone number and Network Address)

Sub-addressing

General Description

The Sub-addressing function allows you further routing, forwarding or relaying of document(s) to the desired recipient(s) when used in combination with the Networking version of HydraFax/LaserFAX software. This function conforms to the ITU-T recommendation for T. Routing-Facsimile Routing utilizing the Sub-address.

Example of a Network

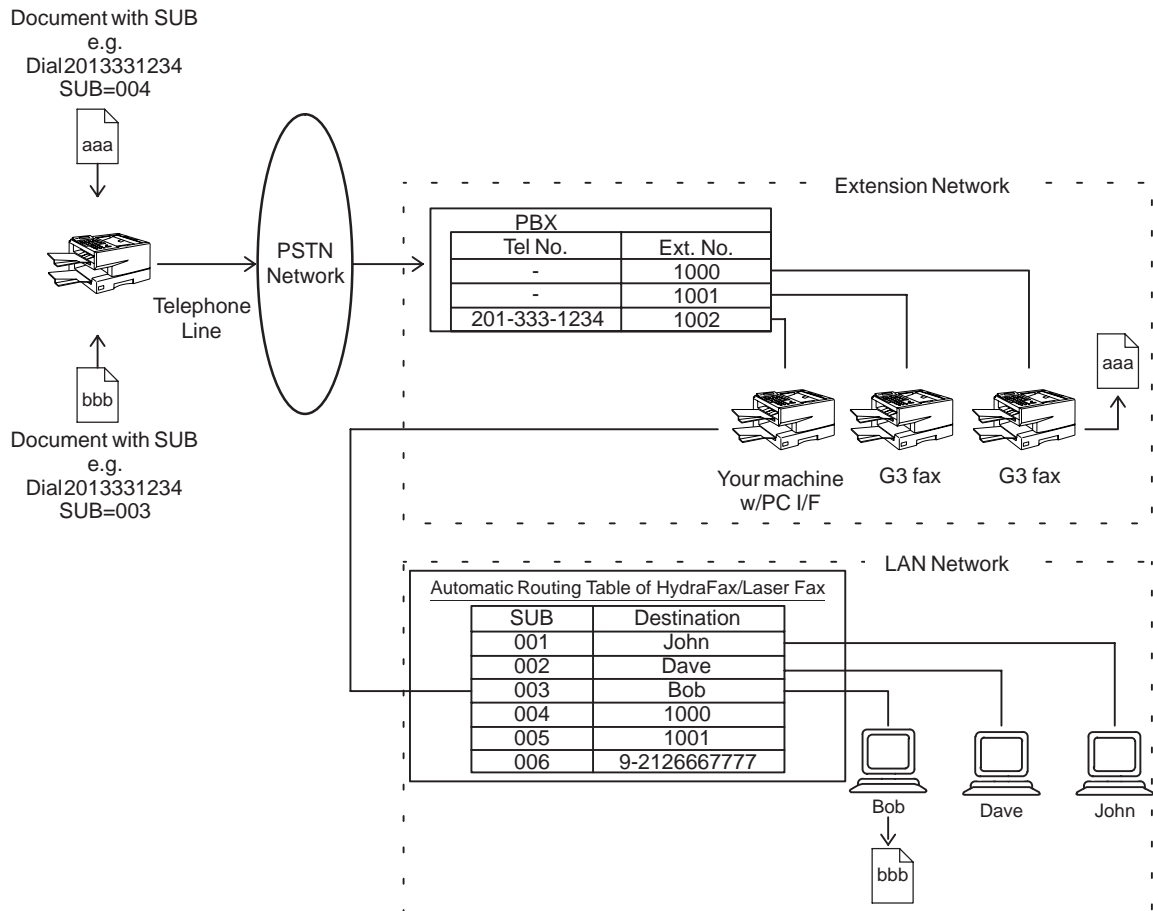

Compatibility with Other Machines

- Sub-addressing Transmission: UF-342/550/560/770/788 (see Note 2)
- Sub-addressing Reception: UF-342/550/560/770/788 with PC Interface using the Networking version of HydraFax/LaserFAX software.

Sub-addressing Transmission Methods

You can send a document with Sub-address information to the desired recipient by the following methods.

- By registering the Sub-address information into One-Touch/ABBR. Dialling Numbers.
- By specifying the Sub-address information in the Manual Number Dialling Mode.

Setting of Routing, Forwarding or Relaying

You can customize the Automatic Routing to any combination of LAN (Local Area Network), PSTN (Public Switched Telephone Network) or PBX Extension with HydraFax/LaserFAX Routing Table (please refer to the HydraFax/LaserFAX User Manual).



Note: 1. HydraFax and LaserFAX are trademarks of Wordcraft International Ltd.
2. UF-788 with PC Interface Option or the Option ROM installed.

Sub-addressing ◀

To set the Sub-address into a One-Touch/ABBR. Dialling Numbers

1

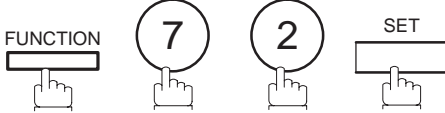

1: ONE-TOUCH
 2: ABBR. NO.

2 Select 1 for One-Touch Dialling number
 Select 2 for ABBR. Dialling Number

Ex: ①

ONE-TOUCH< >
 PRESS ONE-TCH OR V ^

3 Ex:

<01>
 ENTER TEL. NO.

4 Enter the telephone number, press then enter the Sub-address (up to 20 digits).
 (up to 36 digits including telephone number, pauses, spaces, FLASH and Sub-address)
 Ex: Telephone number = 5551234, Sub-address =2762

Enter as: ⑤⑤⑤①②③④
 ②⑦⑥②

<01>
 5551234s2762

5



Enter the station name.

<01> SALES DEPT.

5551234s2762

6



! **Note:** separates the Sub-address from the Telephone number and is indicated by an "s" in the display.

Sub-addressing

To send a Document with Sub-address

Using One-Touch/ABBR. Number Dialling

The operation is the same as for normal Dialling

1  Set document(s) face down.

```
ENTER STATION(S)
THEN PRESS START 00%
```

2 

```
<01> (Station name)
5551234s2762
```

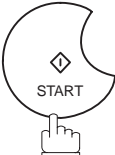
3 

```
* STORE *      NO.001
      PAGES=01  01%
```

The document is stored into memory and your machine starts to dial the number of the station and sends the document(s) with Sub-addressing information.

Using Manual Number Dialling

Use **FLASH** to separate the Telephone number and the Sub-address.

1  Set document(s) face down.

```
ENTER STATION(S)
THEN PRESS START 00%
```

2 Enter the telephone number, press **FLASH** then enter the Sub-address (up to 20 digits).
(up to 36 digits including telephone number, pauses, spaces, FLASH and Sub-address)
Ex: Telephone number = 5551234, Sub-address =2762

```
TEL. NO.
5551234s2762
```

Enter as: (5)(5)(5)(1)(2)(3)(4)
FLASH (2)(7)(6)(2)

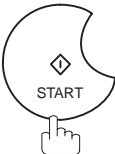
3 

```
* STORE *      NO.001
      PAGES=01  01%
```

The document is stored into memory and your machine starts to dial the number of the station and sends the document(s) with Sub-addressing information.







- !** **Note:**
- FLASH** separates the Sub-address from the Telephone number and is indicated by an "s" in the display.
 - Manual Off-Hook or On-Hook Dialling cannot be used with the Sub-addressing Transmission.
 - The Sub-address is not transmitted during Manual Redial Mode.

Journals and Lists

To help you maintain records of the documents you sent and received, as well as lists of the numbers you record, your facsimile machine is equipped to print the following journals and lists: Transaction Journal, Individual Transmission Journal, Communication Journal, One-Touch/ABBR. No. List, Program List, Fax Parameter List, Power Failure Report and File List.

Transaction Journal

The "Journal" is a record of the last 100* transactions (a transaction is recorded each time you send or receive a document). It is printed out automatically after every 100* transactions (see Note), but you can print or view it manually by using the following procedure (UF-550/560 : 32 transactions) :

1	 	PRINT OUT (1-7) ENTER NO. OR V ^
2	 	JOURNAL 1:PRINT 2:VIEW
3_a		* PRINTING * JOURNAL
3_b		JOURNAL VIEW 1:XMT ONLY 2:ALL
4_b	Select the viewing mode. ① for viewing transmission transactions only ② for viewing all transactions Ex: ②	USE THE V ^ KEYS TO SCROLL EACH RECORD

You can view the transactions in the journal by pressing or . Press to return to standby.

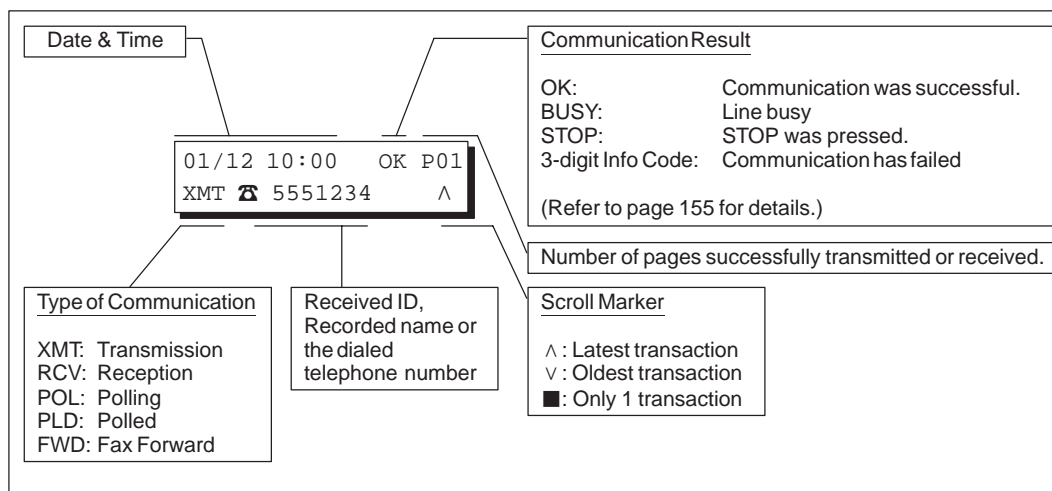

! **Note:** If you wish to disable the automatic print out of the Transaction Journal, change the setting of Fax Parameter No. 13 to "Invalid". (See page 35)

Journals and Lists

Individual Transmission Journal (IND. XMT JOURNAL)

An Individual Transmission Journal contains information on the latest transmission.

1

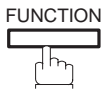

```
PRINT OUT      (1-7)
ENTER NO. OR V ^
```

2



```
6:IND. XMT JOURNAL?
PRESS SET TO PRINT
```

3



```
* PRINTING *
IND. XMT JOURNAL
```

Sample Transaction Journal

***** -JOURNAL- *****									
(1) DATE 08-MAR-1997									
(2) TIME 15:00 *****									
(3)	(4)	(5)	(6)	(7)	(8)	(9)	(10)	(11)	(12)
NO.	COM	PAGES	FILE	DURATION	X/R	IDENTIFICATION	DATE	TIME	DIAGNOSTIC
01	OK	001		00:00'22	XMT	SERVICE DEPT.	07-MAR	17:35	C0044903C0000
02	OK	003		00:01'17	RCV	111 222 333	07-MAR	17:41	C0044903C0000
03	OK	001		00:00'31	XMT	ACCOUNTING DEPT.	07-MAR	17:50	C0044903C0000
04	630	000/005	021	00:00'00	XMT	342345676	07-MAR	17:57	0800420000000
05	STOP	000		00:00'34	XMT	12324567	07-MAR	18:35	0210260200000
06	OK	001/001	022	00:00'20	XMT	44567345	07-MAR	18:44	C8044B03C0000
() () () () () () () () () ()									
31	OK	002/002	023	00:00'31	XMT	0245674533	08-MAR	08:35	C8044B03C1000
32	OK	003/003	024	00:01'32	XMT	0353678980	08-MAR	08:57	C8044B03C1000
(13)									
-PANASONIC -									
***** -HEAD OFFICE - *****									
(15) 201 555 1212- ***** (14)									

Sample Individual Transmission Journal (IND. XMT JOURNAL)

***** -IND. XMT JOURNAL- *****									
(1) DATE 08-MAR-1997									
(2) TIME 15:00 *****									
(10)	(11)	DATE/TIME = 08-MAR-1997 09:00							
(3)	JOURNAL No. = 21								
(4)	COMM.RESULT = OK								
(5)	PAGE(S) = 001								
(7)	DURATION = 00:00'16								
(6)	FILE No. =								
(16)	MODE = TRANSMISSION								
(17)	DESTINATION = [01] / 555 1234 /ABCDEF G								
(18)	RECEIVED ID =								
(19)	RESOLUTION = STD								
(13)									
-PANASONIC -									
***** -HEAD OFFICE - *****									
(15) 201 555 1212- ***** (14)									

Journals and Lists

Explanation of Contents

- (1) Printout date
- (2) Printout time
- (3) Journal number
- (4) Communication result
 - : "OK" indicates that the communication was successful.
 - "BUSY" indicates that the communication has failed because of busy line.
 - "STOP" indicates that **STOP** was pressed during communication.
 - "M-OK" indicates that the substitute reception message in memory was not printed out.
 - "P-OK" indicates that memory overflow or document misfeeding occurred while storing the documents into memory for transmission but successfully stored document(s) was sent.
 - "R-OK" indicates that the Relayed XMT or Confidential Communication was successful.
 - "3-digit Info Code" (see page 155) indicates that the communication has failed.
- (5) Number of pages transmitted or received
 - : The 3-digit number is the number of pages successfully transmitted or received.
 - When the documents are stored into memory, two 3-digit numbers will appear. The first 3-digit number represents the number of pages successfully transmitted. The second 3-digit number represents the total number of pages that were attempted to be transmitted.
- (6) File number
 - : 001 to 255 (If the communication is stored into memory, a file number is assigned for each communication.)
- (7) Duration of communication
- (8) Type of communication
 - : "XMT" means Transmission
 - "RCV" means Reception
 - "POL" means Polling
 - "PLD" means Polled
 - "FWD" means Fax Forward
- (9) Remote station identification
 - : Name : Recorded name in One-Touch or ABBR. Numbers or remote station's Character ID.
 -  number : Dialed telephone number (PIN code will not be shown)
 - Number : Remote station's ID number.
- (10) Communication date
- (11) Communication Start time
- (12) Diagnostic
 - : For service personnel only
- (13) Own LOGO
 - : Up to 25 characters
- (14) Own ID number
 - : Up to 20 digits
- (15) Own Character ID
 - : Up to 16 characters
- (16) Type of communication
 - : Transmission or memory transmission
- (17) Destination
 - : If a One-Touch or ABBR was used for the transmission:
One-Touch or ABBR. No./Telephone Number/Recorded Name
If not : Telephone number
- (18) Received remote station's ID
 - : Character ID/ID number
- (19) Resolution
 - : "STD" means standard resolution
 - "FINE" means fine resolution
 - "S-FINE" means super fine resolution



Communication Journal (COMM. JOURNAL)

The Communication Journal (COMM. JOURNAL) lets you verify if transmission or polling was successful or not. You may select the printout condition (Off/Always/Inc. only) in Function 8-1, or Fax Parameter No. 12.

Sample COMM. JOURNAL

```

***** - COMM. JOURNAL - ***** DATE 08-MAR-1997 **** TIME 15:00 **** P.01

(1)                                     (2)                                     (3)
MODE = MEMORY TRANSMISSION             START=08-MAR 14:50             END=08-MAR 15:00

FILE NO.= 050 (4)

(5)   (6)   (7)   (8)   (9)   (10)
STN NO. COM   ABBR NO. STATION NAME/TEL NO. PAGES DURATION

001   OK   <01>   SERVICE DEPT.   001/001   00:01'30
002   OK   <02>   SALES DEPT.   001/001   00:01'25
003   407  <03>   ACCOUNTING DEPT. 000/001   00:01'45
004   BUSY  ☎     021 111 1234   000/001   00:00'00

                                     - PANASONIC -

***** - HEAD OFFICE - ***** - 201 555 1212 - *****

THE SLEREXE COMPANY LIMITED
SAPORS LANE . BOOLE . DORSET . BH 25 8 ER
TELEPHONE BOOLE (945 13) 51617 - TELEX 123456

Our Ref. 350/PJC/EAC                                     18th January, 1972.

Dr. P.N. Cundall,
Mining Surveys Ltd
    
```

7

... variations of print density ...
 cause the photocell to generate an analogous electrical video signal.
 This signal is used to modulate a carrier, which is transmitted to a
 remote destination over a radio or cable communications link.

At the remote terminal, demodulation reconstructs the video
 signal, which is used to modulate the density of print produced by a
 printing device. This device is scanning in a raster scan synchronised
 with that at the transmitting terminal. As a result, a facsimile
 copy of the subject document is produced.

Probably you have uses for this facility in your organisation.

Yours sincerely,

Phil.

P.J. CROSS
 Group Leader - Facsimile Research

Journals and Lists

Explanation of Contents

- (1) Indication of communication mode
- (2) Start time of communication
- (3) End time of communication
- (4) File number

- (5) Station number
- (6) Communication result

: 001 to 255 (When the communication is stored into memory, a file number is assigned for each communication.)

: Sequential number of the Stations.

: "OK" indicates that the communication was successful.

"BUSY" indicates that the communication has failed because of busy line.

"STOP" indicates that **STOP** was pressed during communication.

"M-OK" indicates that the substitute reception message in memory was not printed out.

"P-OK" indicates that memory overflow or document misfeeding occurred while storing the documents into memory for transmission but successfully stored document(s) was sent.

"R-OK" indicates that the Relayed XMT or Confidential Communication was successful.

"3-digit Info Code" (see page 155) indicates that the communication has failed. In this case, the machine will print out the attached report with first page of your document as shown on the previous page.

- (7) Abbreviated number or  mark
- (8) Recorded name in One-Touch, ABBR. or direct dialling number
- (9) Number of pages transmitted or received

:  mark indicates dialed by direct number dial.

: The 3-digit number is the number of pages successfully transmitted or received.

When the documents are stored into memory, two 3-digit numbers will appear. The first 3-digit number represents the number of pages successfully transmitted. The second 3-digit number represents the total number of pages that were attempted to be transmitted.

- (10) Duration of Communication

One-Touch/Abbreviated and Directory Search List

To print a One-Touch/Abbreviated Number and Directory Search List of the telephone numbers you have stored.

1

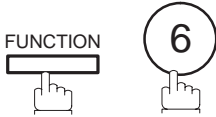

```
PRINT OUT      (1-7)
ENTER NO. OR V ^
```

2



```
2:ONE-TCH/ABBR LIST?
PRESS SET TO PRINT
```

3



```
1:ONE-TOUCH/ABBR.NO.
2:DIR. SEARCH
```

4



for One-Touch/ABBR. Number List

```
* PRINTING *
ONE-TOUCH/ABBR. LIST
```



for Directory Search List

```
* PRINTING *
DIR. SEARCH LIST
```

7

Journals and Lists

Sample One-Touch List

```
***** -ONE-TOUCH LIST- ***** DATE 08-MAR-1997 ***** TIME 15:00 *** P.01

(1)          (2)          (3)
ONE- STATION NAME    TELEPHONE NO.
TOUCH

<01> SERVICE DEPT.    121 555 1234
<02> SALES DEPT.      222 666 2345
<03> ACCOUNTING DEPT  313 333 3456

NO. OF STATIONS = 03 (4)

(see Note)

OWN TELEPHONE NO.=12345678 (9)
OWN NETWORK ADDRESS=1000 (10)
NETWORK PASSWORD=9999 (11)

(see Note)

-PANASONIC -

***** -HEAD OFFICE - ***** 201 555 1212- *****
```

Sample ABBR. Number List

```
***** -ABBR. NO. LIST- ***** DATE 08-MAR-1997 ***** TIME 15:00 *** P.01

(1)          (2)          (3)
ABBR STATION NAME    TELEPHONE NO.
NO.

[01] ENG. DEPT.      888 555 1234
[02] PURCHASE DEPT.  999 666 2345
[03] REGULATION DEPT  777 333 3456

NO. OF STATIONS = 03

(see Note)

OWN TELEPHONE NO.=12345678 (9)
OWN NETWORK ADDRESS=1000 (10)
NETWORK PASSWORD=9999 (11)

(see Note)

-PANASONIC -

***** -HEAD OFFICE - ***** 201 555 1212- *****
```

! **Note:** This information will be printed if the setting of Fax Parameter No.40 (RELAYED XMT REQUEST) or No. 41 (CONF. FAX PARAMETER) is set to "Valid".

Sample Directory Search List

```
***** -DIR. SEARCH LIST- ***** DATE 08-MAR-1997 ***** TIME 15:00 *** P.01
```

(12)	(2)	(1)	(3)	(5)	(6)	(7)	(8)
	STATION NAME	ABBR NO.	TELEPHONE NUMBER	NETWORK ADRS	RELAY STN.	RELAY ADRS	ONE STN XMT
[A]	ACCOUNTING DEPT	<03>	313 333 3456	2002	NO	20	DIRECT
[E]	ENG. DEPT.	[01]	888 555 1234	3000	YES	30	DIRECT
[P]	PURCHASE DEPT	[02]	555 666 2345	3001	NO	30	DIRECT
[R]	REGULATION DEPT	[03]	777 333 3456	3002	NO	30	DIRECT
[S]	SALES DEPT.	<01>	121 555 1234	2000	YES	20	DIRECT
	SERVICE DEPT	<02>	222 666 2345	2001	NO	20	DIRECT

(see Note)

NO. OF STATIONS = 06 (4)

OWN TELEPHONE NO. = 12345678 (9)
 OWN NETWORK ADDRESS = 1000 (10)
 NETWORK PASSWORD = 9999 (11)

(see Note)

-PANASONIC -

```
***** -HEAD OFFICE - ***** 201 555 1212 - *****
```



Note: This information will be printed if the setting of Fax Parameter No. 40 (RELAYED XMT REQUEST) or No. 41 (CONF. FAX PARAMETER) is set to "Valid".

Explanation of Contents

- | | |
|--|--|
| (1) One-Touch number or Abbreviated number | : <nn> = One-Touch number, [nn] = Abbreviated number |
| (2) Station name recorded in the machine | : Up to 15 characters |
| (3) Telephone number recorded in the machine | : Up to 36 digits |
| (4) Number of recorded One-Touch and ABBR. numbers | |
| (5) Network Address | : 4-digit |
| (6) Relay Station | : Yes/No |
| (7) Relay Address | : 2-digit |
| (8) One Station XMT | : Relay/Direct |
| (9) Own telephone number | : Up to 36 digits |
| (10) Own Network Address | : 4-digit |
| (11) Network Password | : 4-digit |
| (12) The first letter of station name recorded in your machine | |

Journals and Lists

Program List

To print a Program List of the Dialling Patterns that you have previously entered into the Program Keys.

1

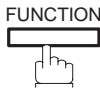

```
PRINT OUT      (1-7)
ENTER NO. OR  V ^
```

2



```
3:PROGRAM LIST?
PRESS SET TO PRINT
```

3



```
* PRINTING *
PROGRAM LIST
```

Sample Program List

```
***** -PROGRAM LIST- ***** DATE 08-MAR-1997 ***** TIME 15:00 *** P.01

(1)      (2)      (3)      (4)      (5)
PROGRAM  PROGRAM NAME  TYPE      TIMER      ABBR.NOS.

[P1]     TIMER XMT      XMT       12:00      [01]
[P2]     TIMER POLL    POLL      19:00      [02]
[P3]     PROG. A       POLL      -----    [01] [02]
[P4]     PROG. B       ABBR/GRP  -----    [01] [02] [03]

                                           -PANASONIC -

***** -HEAD OFFICE - ***** 201 555 1212- *****
```

Explanation of Contents

- (1) Program key
- (2) Program name : Up to 15 characters
- (3) Type of communication : "XMT" indicates transmission.
"POLL" indicates polling.
"ABBR/GRP" indicates that the Program key is programmed as a group key.
"ONE-TOUCH" indicates that the Program key is programmed as a One-Touch key.
- (4) Timer : Indicates the starting time.
"----" indicates that the Program key contains "non-deferred" program.
- (5) Numbers recorded in the program : One-Touch/ABBR. numbers

FAX Parameter List

To print out a FAX Parameter List:

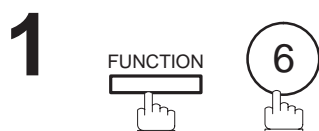

```
PRINT OUT      (1-7)
ENTER NO. OR V ^
```



```
4:FAX PARA LIST?
PRESS SET TO PRINT
```

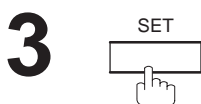

```
* PRINTING *
FAX PARAMETER LIST
```

7

Sample FAX Parameter List

```
***** -FAX PARAMETER LIST- ***** DATE 08-MAR-1997 ***** TIME 15:00 *****
```

(1) PARAMETER NUMBER	(2) DESCRIPTION	(3) SELECTION	(4) CURRENT SETTING	(5) STANDARD SETTING
01	CONTRAST (HOME)	(1:Normal 2:Lighter 3:Darker)	1	1
02	RESOLUTION (HOME)	(1:Standard 2:Fine 3:S-Fine)	2	1
04	STAMP (HOME)	(1:Off 2:On)	1	1
99	MEMORY SIZE		(512KB + 1MB)	(6)

-PANASONIC -

```
***** -HEAD OFFICE - ***** 201 555 1212- *****
```

Explanation of Contents

- | | | |
|----------------------|----------------------|---|
| (1) Parameter number | (4) Current setting | : "----" indicates code or password is not set. When the code or password is set, it is shown in parenthesis. When RCV To Memory Password is set, ■■■■ is shown in parenthesis. |
| (2) Description | (5) Standard setting | : "(HOME)" means home position setting. : Factory preset standard setting |
| (3) Selection | (6) Memory sizes | : (Base memory + option memory) |

0000 Journals and Lists

Power Failure Report

The UF-770 has a built-in rechargeable battery installed to retain the document information for up to 1 hour when a power failure occurs.

However, if the battery system has problems, the document information might be lost. In this case, a Power Failure Report will be printed automatically for each file separately, after the Power is turned ON again. This report is not printed if there were no files in the memory.

Sample Power Failure Report

```
***** -POWER FAILURE REPORT- ***** DATE 08-MAR-1997 ***** TIME 15:00 *** P.01

POWER FAILURE OCCURRED !

FROM *** 08-MAR-1997 10:00 *** (1)

TO *** 08-MAR-1997 15:00 *** (2)

FOLLOWING FILE(S) HAS BEEN LOST.
```

(3) FILE NO.	(4) COMM. TYPE	(5) ABBR NO.	(6) STATION NAME/TEL NO.	(7) PAGES
002	MEM.POLLED XMT			003
003	RCV TO MEMORY			005
015	MEM.DEF.XMT	<01> <02>	SALES DEPT. SERVICE DEPT	000/003 000/003
018	MEMORY XMT	<03> ☎	ACCOUNTING DEPT. 021 111 1234	005/005 000/005

```

-PANASONIC -
***** -HEAD OFFICE - ***** 201 555 1212- *****
```

Explanation of Contents

- (1) Power failure date and time
- (2) Power return date and time
- (3) File number : 001 to 255. (When the communication for each communication)
- (4) Communication type
- (5) Abbreviated number or ☎ mark : ☎ mark indicates dialed by Manual Number dialling
- (6) Recorded name in One-touch, ABBR. or Manual Number dialling
- (7) Number of pages stored : The first 3-digit number represents the number of page successfully transmitted. The second 3-digit number represents the number of pages stored in memory.

If You Have Any of These Problems

Mode	Symptom	Action	page
During Installation	The display is blinking	Battery discharged completely. This may happen at first installation. After setting the clock, the blinking will stop.	25
During Transmission	Document doesn't feed/multiple feed	<ol style="list-style-type: none"> 1. Check that your document is free of staples and paper clips, and that it is not greasy or torn. 2. Check that your document is the right type to send through a fax machine by consulting the list on "Documents You Cannot Send". If your document has the characteristics listed, make a photocopy of your document and send the copy instead. 3. Check that the document is loaded properly. 4. Adjust the ADF Pressure Plate. 	39 40 162
	Document jam	The information code 031 will appear on the display if the document becomes jammed.	159
	Does not stamp	<ol style="list-style-type: none"> 1. Check if Stamp LED is lit. 2. Check Fax parameter No. 04 and No. 28 settings. 	42 35,36
	Stamp too light	Replace stamp or refill ink.	163
Transmission Copy Quality	Vertical lines on the transmitted document	Check own copy quality. If copy is OK, your machine has no problem, report to receiving party that they have a problem. If copy is NG, clean the Document Scanning Area.	160
	Transmitted document is blank	<ol style="list-style-type: none"> 1. Make sure the document is set face down. 2. Check own copy quality. If copy is OK, your machine has no problem, report to receiving party that they have a problem. If copy is NG, clean the Document Scanning Area. 	160
During Reception	No recording paper	The information code 010 will appear on the display if the paper runs out.	18
	Recording paper jam	The information code 001, 002 or 003 will appear on the display if the paper gets jammed.	158
	Recording paper doesn't advance into machine	Make sure that there is paper in the Paper Cassette. Follow the instructions for loading paper.	18
	Recording paper doesn't eject after printing	Check to see if the recording paper is jammed inside of the machine.	158
	Recording papers are not stacked in sequence. Machine does not print from the last page received.	<ol style="list-style-type: none"> 1. Check if Fax Parameter No. 65 is set to valid. 2. If memory becomes full during reception, the machine will start to print from the 1st page received. We recommend that optional memory is installed if this symptom occurs frequently. 	38 170
	Document auto reduction doesn't work	Check Print Reduction settings.	61
	Out of toner	The information code 041 will appear on the display if the Toner Cartridge runs out of toner.	16

Troubleshooting

Mode	Symptom	Action	page
Print Copy Quality	Vertical lines printing on the received document	Printout a Journal report (e.g. FUNCTION, 6, 1 and SET) and check quality to make sure if your machine has trouble or not. If Journal report quality is OK, your machine has no problem, report to sending party that they have a problem. If copy is NG, replace the Toner Cartridge.	141 16
	Fuzzy print	1. Make sure you are using the correct paper for the best possible print quality. 2. Try reversing the recording paper to the other side.	168
	Missing dots or lines/inconsistent darkness within print	1. Make sure you are using the correct paper for the best possible print quality. 2. Replace the Toner Cartridge.	168 16
Print Copy Quality	Fading print	The Toner Cartridge may be running out of toner. Replace the Toner Cartridge.	16
	Faint print	You may need to choose a different paper for the best possible print quality.	168
Communication	No dial tone	1. Check the connection of the telephone line. 2. Check the telephone line.	164
	No auto answer	1. Check the connection of the telephone line. 2. Check the Reception mode setting. 3. Check if machine is printing a report. (e.g.: Transaction Journal, Fax Parameter List). If machine is printing a report, machine cannot receive until printing is completed. 4. If the printed document is the final Transaction to print the Transaction Journal automatically, machine will usually print the Transaction Journal automatically after printing out the document. In this case, the machine cannot receive until the Transaction Journal has been printed.	164 60
	Cannot transmit or receive	An information code will be shown on the display. Refer to the information code table to find out the trouble.	155
No Unit Operation	No unit operation	To reset the machine, turn-off the Power Switch for a few second then turn-on again.	21

Information Codes

When something unusual occurs, the display may show one of the Information Codes below. These will help you to identify and correct the problem.

Info. Code	Meaning	Action	Page
001/002	Recording paper jam.	Remove jammed paper.	158
010	No recording paper.	Load the paper.	18
011	Recording Paper Cassette is not installed properly.	Install the Recording Paper Cassette.	--
017	Incorrect paper size loaded in the Paper Cassette.	Load the Paper Cassette with proper paper size (A4, LRT or LGL).	18
030	Document misfeeding.	1. Reload the document properly. 2. Remove document jam. 3. Adjust ADF.	40 159 162
031	Document paper is too long or jammed. Document length exceeds 2 meters.	1. Reload the document properly. 2. Remove document jam.	40 159
041	Out of toner.	Replace the Toner Cartridge.	16
045	Toner Cartridge is not installed.	Install the Toner Cartridge.	16
060	Printer Cover is opened.	Close the Printer Cover.	--
061	ADF Door (Document Return Guide) is open.	Close the ADF Door.	--
063	Jam Access Cover 1 (Optional 2nd Feeder Unit) is open.	Close the Jam Access Cover 1.	--
064	Jam Access Cover 1 (Optional 3rd Feeder Unit) is open.	Close the Jam Access Cover 1.	--
400	During initial handshake, receiving station did not respond or communication error occurred.	1. Check with other party. 2. Reload the document and send again.	--
401	Remote station required a Receiving Password to receive the document. Remote station does not have Confidential Mailbox.	Check the remote station.	--
402	During initial handshake, communication error occurred.	Reload the document and send again.	--
403	No polling capability at the remote side.	Ask remote side to set "POLLED=ON".	--
404/405	During initial handshake, communication error occurred.	Reload the document and send again.	--

Troubleshooting

Info. Code	Meaning	Action	Page
406	Transmission Password does not match. Receiving Password does not match. Received from an unauthorized station in Selective Reception mode.	Check the password or the telephone number in One-Touch or Abbreviated station.	111 113 114
407	No confirmation from the receiving station for the previous page sent.	Wait a few minutes and send again.	--
408/409	Remote side confirmation of previous page is illegible.	Wait a few minutes and send again.	--
411	Polling password does not match.	Check polling password.	67
412	No data from the transmitting side.	Check with the other party.	--
414	Polling password does not match.	Check polling password.	67
415	Polling transmission error.	Check polling password.	67
416/417 418/419	Received data has too many errors.	Check with the other party.	--
420	Machine goes to receiving mode, but receives no command from the transmitting side.	1. Remote side misdial. 2. Check with the other party.	--
422/427	Interface is incompatible.	Check with the other party.	--
430/434	Communication error occurred while receiving.	Check with the other party.	--
436/490	Received data has too many errors.	Check with the other party.	--
456	<ul style="list-style-type: none"> • Unit received a confidential document or was requested to be polled of a confidential document under any of following conditions. <ol style="list-style-type: none"> 1) Memory does not have enough space to receive the confidential document. 2) Confidential Mailbox file is full. 3) While printing received document. • Unit was requested to relay a document. 	1. Printout File List then check the contents. 2. Wait a moment until finishing the printing.	76
492/493 494	Communication error occurred while receiving.	Check with the other party.	--
495	Telephone line disconnected.	Check with the other party.	--

Info. Code	Meaning	Action	Page
540/541 542 543/544	Communication error occurred while transmitting.	1. Reload the document and send again. 2. Check with the other party.	--
550	Telephone line disconnected.	Check with the other party.	--
552/553 554/555	Communication error occurred while receiving.	Check with the other party.	--
580	Sub-address transmission to a unit that has no Sub-address function.	Check the remote station.	138
581	Sub-address Password transmission to a unit that has no Password Sub-address function.	Check the remote station.	138
601	ADF Door was opened during ADF transmission.	Close the ADF Door.	159
623	No document was on the ADF.	Reload the document and send again.	--
630	Redial was not successful due to a busy line or no response from the called station.	Reload the document and send again.	--
631	During dialling, STOP was pressed.	Reload the document and send again.	--
634	Redial was not successful due to a busy line or no response from the called station.	Reload the document and send again.	--
638	Power failure occurred during the communication.	Check the power cord and plug.	20
870	Memory overflow occurred while storing documents into memory for transmission.	Transmit documents without storing into memory. Order additional memory option.	51 169
879	Memory overflow occurred while receiving documents into memory. Receiving documents with data that is greater than the memory size.	1. Check recording paper and toner cartridge. 2. Install Optional Memory Card.	16 18
975	DRAM parity error. The document information in memory is lost.	1. Unit will print out a Power Failure Report. 2. Resend the lost document.	152

Troubleshooting

Clearing a Recording Paper Jam

If the recording paper becomes jammed in the machine, the display will show an Information Code 001 or 002.

To clear the jam, Info. Code 001

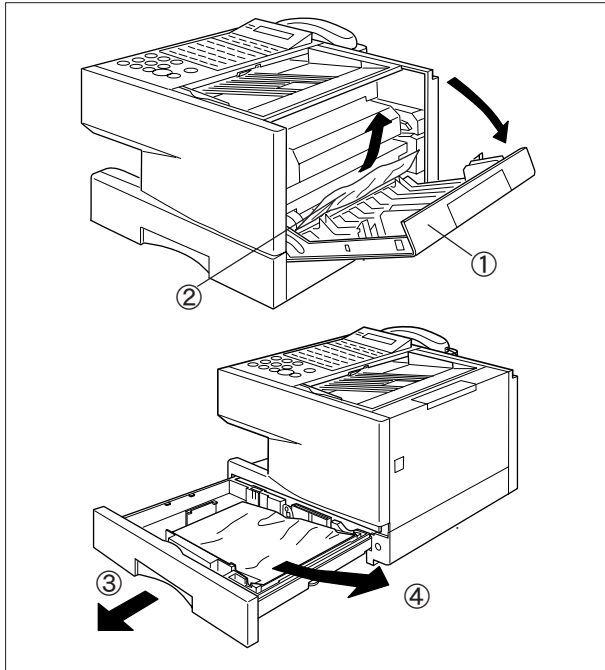

- ① Open the Printer Cover.
- ② Remove the jammed paper.
- ③ Slide out the Paper Cassette.
- ④ Remove the jammed or wrinkled paper and reload the recording paper into the paper cassette.

Caution: Make sure that the paper is set under the clips of the Paper Cassette. You can load about 250 sheets with standard weight paper (20 lb. or 75 g/m²). For paper specification see page 168

To clear the jam, Info. Code 002

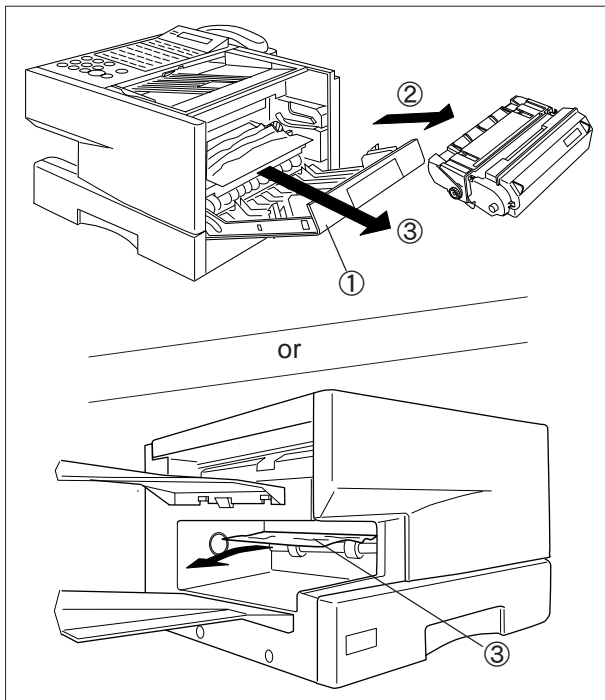

- ① Open the Printer Cover.
- ② Remove the Toner Cartridge.
- ③ Remove the jammed paper.



Note: The Recording Paper Jam message display is reset only by opening and closing of the Printer Cover.

Clearing a Document Jam

If a document becomes jammed in the machine, the display will show the Information Code 031.

To clear the jam

1

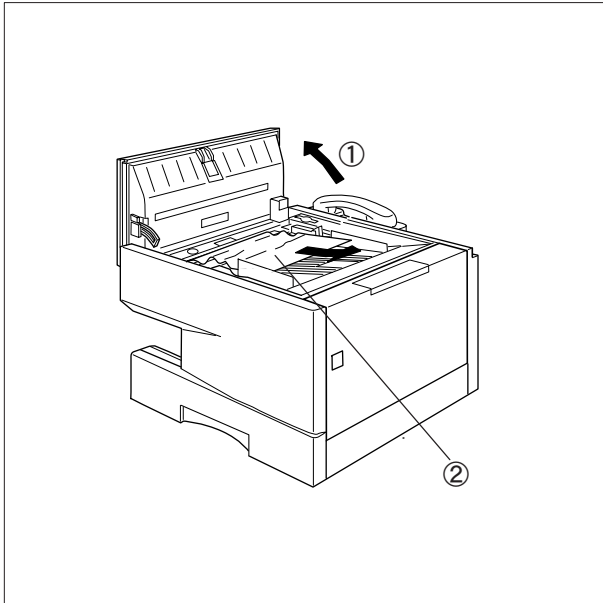

- ① Open the ADF Door.
- ② Remove the jammed document.

0000 Troubleshooting

Cleaning the Document Scanning Area

If the receiving party reports that the received documents were black, or contained black lines, make a copy on your unit to verify. If the copy is black or has black lines, the document Scanning Area is probably dirty and must be cleaned.

To clean the Scanning Area

1

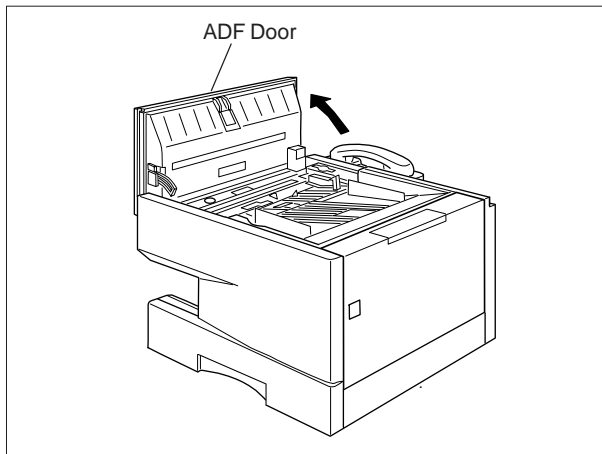

Open the ADF door.

2

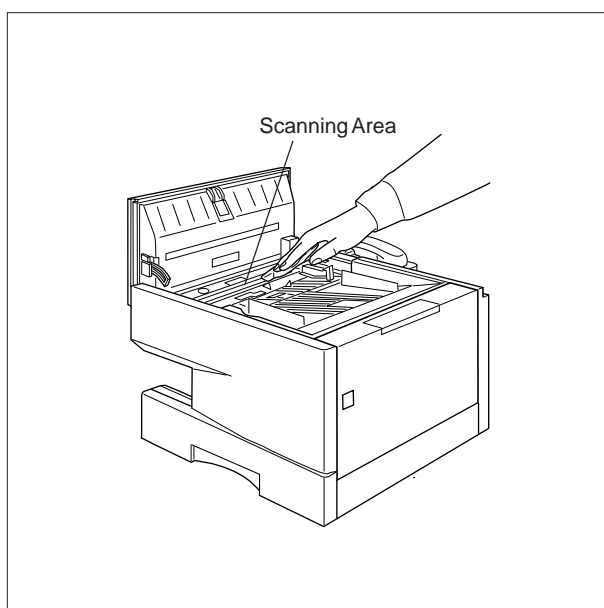

Wipe the Scanning Area gently with a soft cloth gauze wet with ethyl alcohol. Be sure to use a clean cloth, the scanning area can be easily scratched.

Cleaning the Printer Roller

If you find toner on the back of the recording paper, the printer roller in the fuser unit is probably dirty.

To clean the printer roller

1

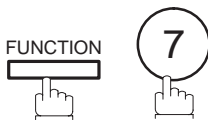

```
SET MODE      (1-6)
ENTER NO. OR V ^
```

2

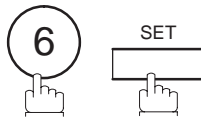

```
PLEASE WAIT FOR
PRINTOUT TEST CHART
```

Machine will print out 3 pages of the Cleaning Chart.

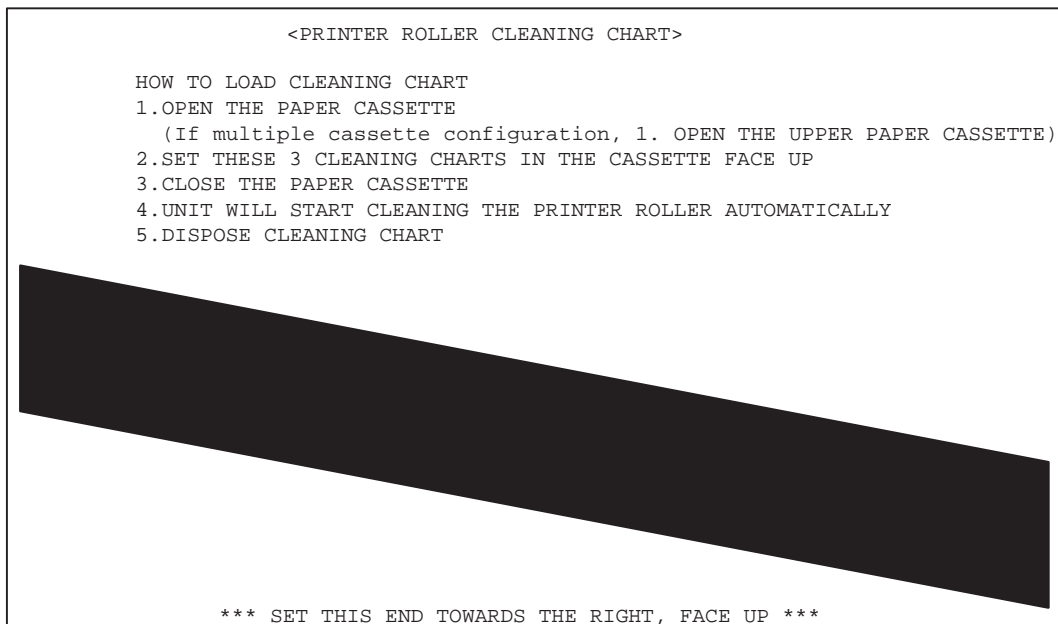

After printing the Cleaning Charts, the following message will appear.

```
LOAD CHART IN PAPER
CASSETTE FACE UP
```

3

Slide out the paper cassette from the machine. Then, load the Cleaning Charts into the cassette face up. (See Note)

4

Close the paper cassette. Machine will automatically feed out the charts in order to clean the printer roller.

```
* CLEANING *
PRINTER ROLLER
```



Note: If you have installed the optional 2nd cassette, load the Cleaning Chart into the upper cassette.

0000 Troubleshooting

Adjusting the Automatic Document Feeder (ADF)

If document misfeeding occurs frequently, we suggest you to adjust the ADF.

To adjust the ADF,

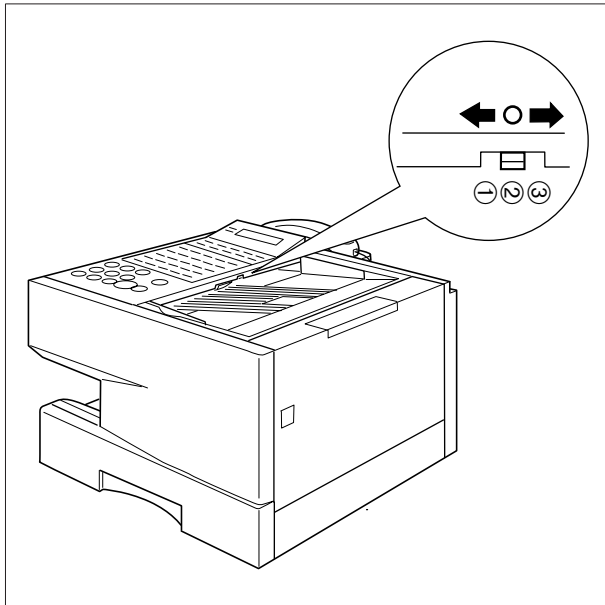

Pull the blue Pressure Adjusting Lever upward and slide it to the desired position depending on the condition.

Position	Condition
1	To prevent no feed trouble
2	Standard position
3	To prevent multiple feed trouble

Verification Stamp

The Verification Stamp contains ink. When the stamp mark appears faded or hard to see, the stamp should be replaced or refilled with ink.

To remove the stamp

1

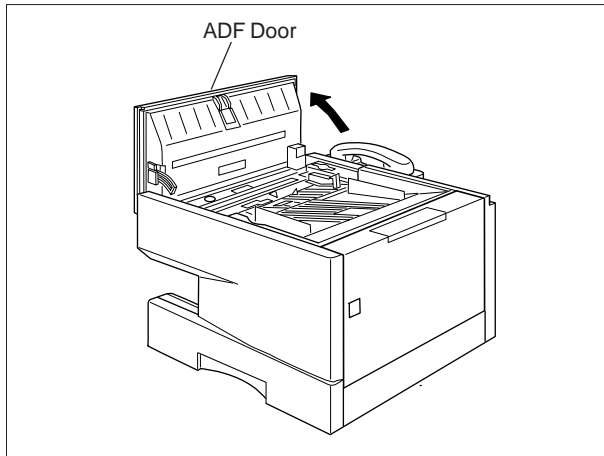

Open the ADF door.

2

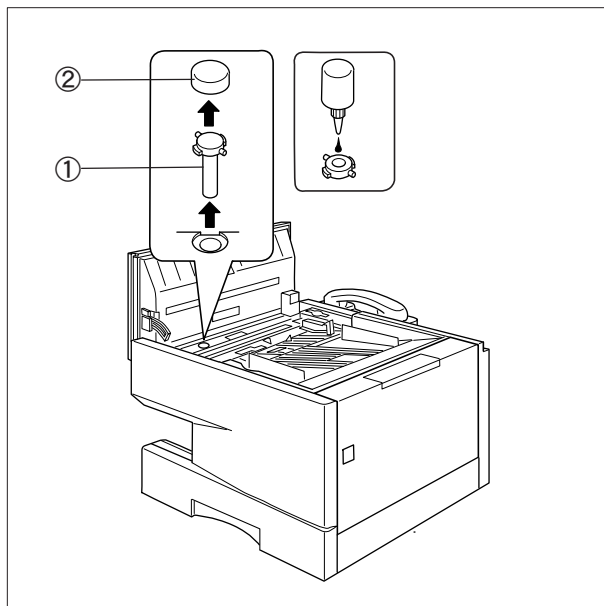

① Remove the Stamp Assembly upward.

② Remove the Stamp. Replace the stamp with a new one or refill the stamp with a few drops of the specified ink into the back of the stamp.



Note: Please contact your local Panasonic dealer to purchase a new stamp. See page 170 for order number.

0000 Troubleshooting

Checking the Telephone Line

When you do not hear a dial tone through the telephone connected to the machine or when the telephone does not ring (No automatic receive).

1

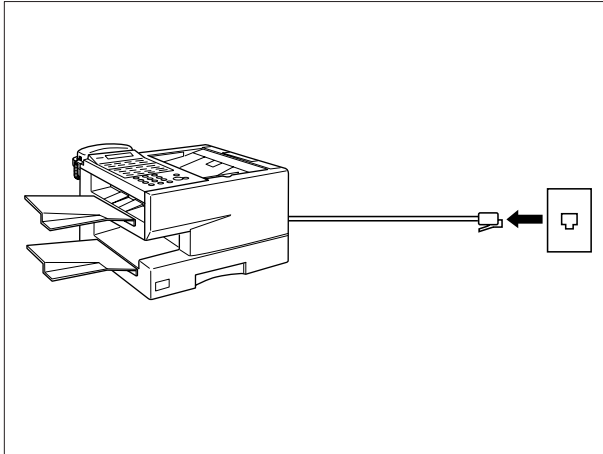

Unplug the Telephone Line Cord from the telephone jack that was supplied by the telephone company.

2

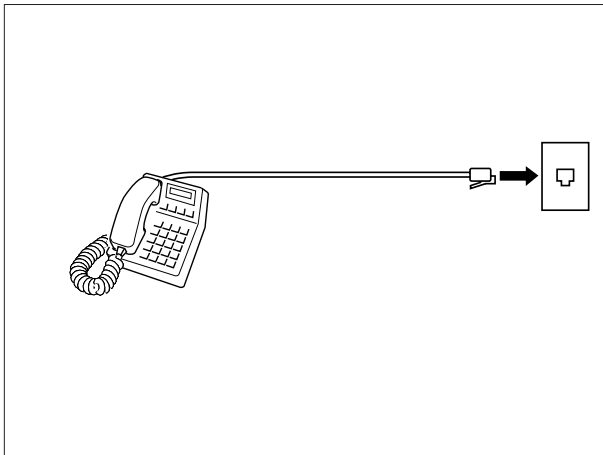

Plug a different regular telephone into the same telephone jack.

3

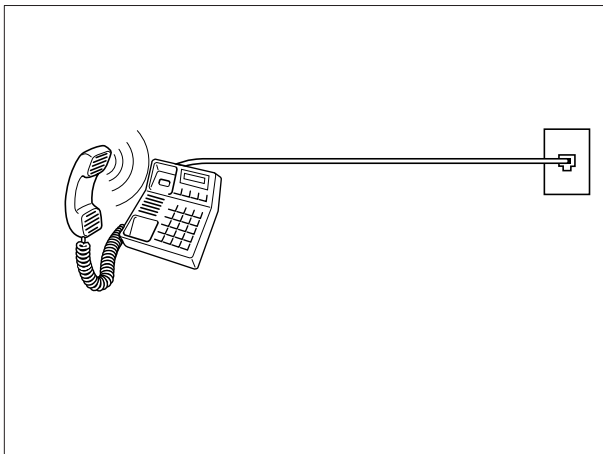

Check for dial tone through the handset. If there is still no dial tone, report it to your local telephone company.

or

Call from another telephone to this number. If the telephone does not ring, report it to your local telephone company.

Compatibility	ITU-T/CCITT Group 3
Coding Scheme	MH, MR, MMR (Conforms to ITU-T/CCITT Recommendations)
Modem Type	ITU-T/CCITT V.17, V.33, V.29, V.27 ter and V.21 for UF-560/770 ITU-T/CCITT V.29, V.27 ter and V.21 for UF-550
Modem Speed	14400 - 2400 bps for UF-560/770 9600 - 2400 bps for UF-550
Document Size	Max. : 280 mm x 2000 mm (with operator's assistance) Min. : 148 mm x 128 mm
Document Thickness	Single sheet : 0.06 mm (45 g/m ²) to 0.15 mm (112 g/m ²) Multiple sheets : 0.06 mm (45 g/m ²) to 0.12 mm (75 g/m ²)
ADF Capacity (Automatic Document Feeder)	Built-in, up to 50 sheets for UF-770 up to 30 sheets for UF-550/560
Scanning Method	Sheet Feeding with CCD type image sensor
Effective Scanning Width	252 mm for UF-770 212 mm for UF-550/560
Scanner Resolution	Horizontal : 8 pels/mm Vertical : 3.85 lines/mm 7.7 lines/mm 15.4 lines/mm : Transmission only
Recording Method	Laser printer
Recording Paper	Plain Paper
Recording Paper Size	Letter, A4 or Legal
Printer Resolution	406 × 391 dpi

Specifications

Effective Recording Size

Letter : 208 mm x 271 mm
 A4 : 202 mm x 289 mm
 Legal : 208 mm x 348 mm

Print Margin

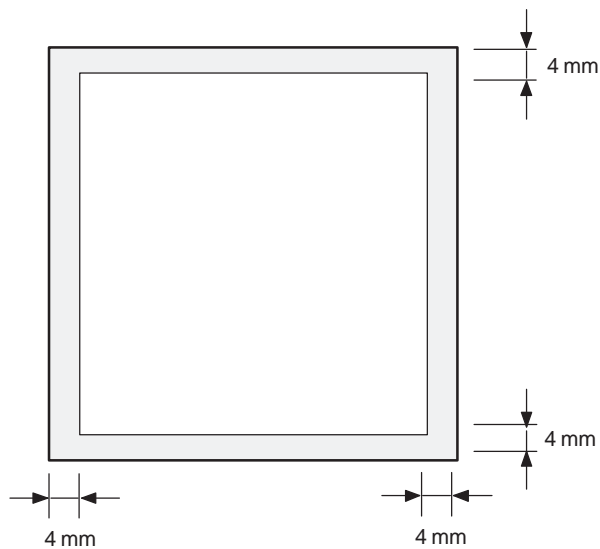

Recording Paper Capacity

Approx. 250 sheets (using 75 g/m² paper)

One-Touch/Abbreviated Dialling Memory Capacity

100 stations for UF-550/560
 (including 24 One-Touch keys and 4 Program keys)
 140 stations for UF-770
 (including 32 One-Touch keys and 8 Program keys)
 Each station can register up to 36 digits for each telephone number
 (including pauses and spaces) and up to 15 characters for each station
 name

Image Memory Capacity

	UF-550/560	UF-770
Base Memory	12 pages	70 pages
with 1 MB Memory Card	97 pages	155 pages
with 2 MB Memory Card	177 pages	235 pages
with 4 MB Memory Card	347 pages	405 pages
with 8 MB Memory Card	—	740 pages

(Based on ITU-T/CCITT Image No.1 using Standard Resolution)
 (8 MB Memory Card is available for UF-770)

Specifications ◀

Power Supply	180 - 264 VAC, 47 - 63Hz, Single Phase : 200 V version (90 - 138 VAC, 47 - 63Hz, Single Phase : 100 V version)
Power Consumption	Standby : Approx. 8Wh (100 V version) 11Wh (200 V version) (UF-550/560/770 Power Saver Mode : On) : Approx. 48Wh (UF-550/560 Power Saver Mode : Off) : Approx. 84Wh (UF-770 Power Saver Mode : Off) [Room temperature : 25°C] Transmission : Approx. 20W Reception : Approx. 460W Copy : Approx. 460W Max : Approx. 460W
Dimensions	430 mm (W) x 415 mm (D) x 280 mm (H) (excluding Projections and optional Paper Cassette)
Weight	Approx. 15 kg (excluding consumable supplies and options)
Operating Environment	Temperature : 10 to 35°C Relative Humidity : 15 to 70%

Recording Paper Specifications

In general, most photocopy papers will also work very well. There are many "name" and "generic" brands of paper available. We recommend that you test various papers until you obtain the results you are looking for.

The following table summarizes the major specifications to consider when selecting white or colored paper.

Basic Weight	60 to 90 g/m ²
Cut Edge Conditions	Cut with sharp blades, no visible frayed edges
Grain	Long grain
Moisture Content	3.7% to 5.3% by weight
Opacity	88% minimum
Packing	Polylaminated moisture-proof ream wrap
Sizes	A4 : 210 mm x 297 mm Letter : 216 mm x 279 mm Legal : 216 mm x 356 mm
Type	Cut sheet (No curled)





Note: *It is possible that paper could meet all of the specifications listed above and still not print well because of the variations in paper manufacturing. Therefore, we recommend that you test paper thoroughly before purchasing.*

Options and Supplies

Please contact your local Panasonic dealer for availability.

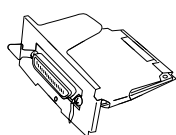
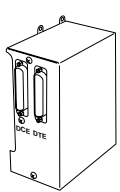
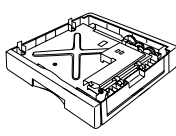
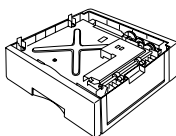
A. Options:

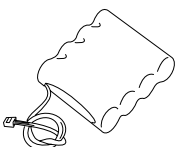
Order No.	Picture	Description	Available Models
UE-403117		Handset Kit	UF-550 UF-560
UE-404053		Parallel Port Interface Kit (Used for Printer or PC Interface)	UF-550
UE-404062			UF-560
UE-404058			UF-770
UE-404056		V.24/Encryption Interface Kit	UF-770
UE-409051 or UE-409057		250 sheets Letter / Legal / A4 Size Paper Cassette with the Feeder Unit	UF-550 UF-560
UE-409057			UF-770
UE-409056		500 sheets Letter / Legal / A4 Size Paper Cassette with the Feeder Unit	UF-770
UE-410006		Expansion IC Memory Card, 1 MB	UF-550 UF-560 UF-770
UE-410007		Expansion IC Memory Card, 2 MB	
UE-410008		Expansion IC Memory Card, 4 MB	
UE-410029		Expansion IC Memory Card, 8 MB	
UE-403125		72 hours battery back-up option kit	UF-770

09003080010



Note: For some countries, the handset may not be available because of the country's regulation or specification.

Options and Supplies

B. Supplies:

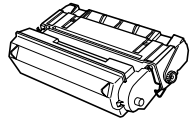
Order No.	Picture	Description	Available Models
FX-13-2P		Verification Stamp	UF-550 UF-560 UF-770
UG-3313		Toner Cartridge	UF-550 UF-560 UF-770

Installing Memory Card

Before installation begins, make sure that there is no document file stored in the memory. You may confirm by print out a File List (see page 76). When the memory card is installed, the machine will initialize the document memory, all contents stored in the document memory will be lost.

1

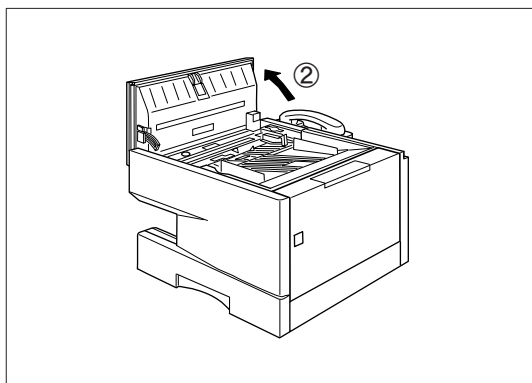

① Turn the Power Switch to the "O" (OFF) position located in the rear of the machine.

② Open the ADF Door

2

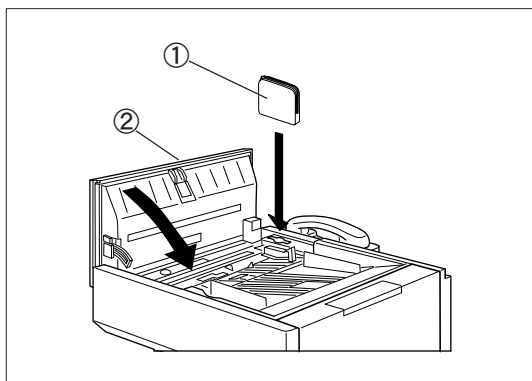

① Insert the Memory Card into the card slot with the Panasonic logo facing to the rear.

② Close the Transmitting Cover

3

Turn the Power Switch to the "I" (ON) position. Print out the Fax Parameter List (see page 151) and confirm the memory size on Fax Parameter No. 99. (see page 38)



Note: The document(s) stored in memory will be lost if the memory card is removed.

Glossary

ABBR. No. (Abbreviated Number)	The ability to store full phone numbers into the dialer and then utilizing a short series of keystrokes to speed dial that number in the future.
ADF (Automatic Document Feeder)	The mechanism that delivers a stack of document pages to the scanner one page at a time.
Automatic reception	The mode that allows you to receive fax documents without user intervention.
Auto print reduction	The method of automatically reducing a received document so that it can be printed onto a standard size piece of plain paper. For example, your machine will reduce an incoming legal size page to 75% of its original size so it could fit on a letter size page.
BPS (Bits Per Second)	The amount of data that is transmitted over the phone line. Your machine can start at each Max. Modem speed and automatically steps down to suitable speed depending on the phone line condition and the receiving machines capabilities. (Max. Modem Speed UF-550: 9600 BPS / UF-560/770: 14400 BPS)
C.C.I.T.T.	Consultative Committee on International Telegraph and Telephone. This organization has presently developed four groups of industry standards that insure facsimile compatibility.
CCITT Image No.1 (ITU-T/CCITT)	An industry standard document that allows comparisons of the transmission speeds and capabilities of facsimile machines.
Character ID	A programmed proprietary code name that allows up to 16 alphanumeric characters identifying your facsimile machine.
Character keys	The keys that are used to enter letters and symbols for various programming functions.
Coding scheme	The data compression method used by facsimile machines. Your machine utilizes Modified Huffman (MH), Modified Read (MR), and Modified Modified Read (MMR) coding schemes.
COMM. JOURNAL	Refers to either the Communication Journal, Relay Transmission Report, or the Confidential XMT Report.
Confidential communication	In a network of facsimile machines, a code can be entered to retrieve a document that is stored in memory of a designated relay station.
Confidential XMT Report	The report that gives you information about the transmission of a confidential document(s) to a relay station.
CONTRAST	Signifies the scanning sensitivity in terms of lightness and darkness of your original transmitting pages.
Cover Sheet	A Fax Cover Sheet can be attached to your transmit document(s) that shows the recipient's name, originator's name and number of pages attached.

DDD (Direct Distance Dialing)	A telephone service that allows unassisted dialling, no operator assistance is required.
Deferred polling	The ability to retrieve documents from other stations at a later time.
Deferred transmission	The ability to send documents to other stations at a later time.
Department Code	This operation require the user to input a preset 4-digit Department Code before transmission. The Department Name of selected Department Code is printed on the Header of each page sent, Cover Sheet, COMM. Journal and Individual Transmission Journal.
Direct Dialling	The method of dialling where you enter the entire telephone number through the keypad.
Directory Search Dialling	Allows you to dial a full telephone number by searching the station's name entered in the One-Touch keys or Abbreviated dialling numbers.
Directory Sheet	The list that contains the station names that are programmed into your unit.
DTMF (Dual Tone Multi-Frequency)	Dialling method that sends a different set of frequencies for each digit of the telephone keypad. Commonly refers to touch tone Dialling.
ECM (Error Correction Mode)	The ability to correct transmission errors as detected during the transmitting phone call.
End receiving station	In a relay network, the final station designated to receive the document.
FAX Access code	A 4-digit programmable code that prevents unauthorized operation of your Fax.
FAX Forward	The ability to forward all incoming faxes to the station registered in the ABBR. No. [00].
FAX Parameter List	The list that contains the home FAX parameters settings that you have programmed into your machine.
File	A task that has been stored into the memory of your unit. Examples are deferred transactions.
File Transmission	A feature that allows you to store a perpetual File (until it is erased) in the memory that can be sent to a single or multiple stations repeatedly.
Fixed print reduction	The method that allows you to determine one reduction rate, such as 75%, for all incoming documents.
FUNCTION	The control panel key that will be utilized to begin an operation or configuration of a feature.
G3 mode (Group 3)	Refers to the standards and transmission capabilities of the current generation of facsimile machines.

Glossary

Group dialling	The ability to program many telephone numbers into a single station so that many locations can be dialed in sequence utilizing a single keystroke.
HALFTONE	A scanning technique to distinguish levels of gray from black and white. Your machine can detect up to 64 levels of gray in halftone mode.
Handshaking	The exchange of a group of control signals that communicate between the transmitter and receiver. These signals determine the condition at which communication can occur.
Header	A row of information that is transmitted by the sending machine and printed on the top of each page by the receiving unit. This identifies the transmitting unit and information about the transmission, such as time and date.
ITU-T	International Telecommunication Union - Telecommunication, formerly known as C.C.I.T.T.
ID	A programmable address of up to 20 digits identifying your machine.
Image memory capacity	This signifies the amount of memory available in your unit capable of storing pages of documents. All page units of measure are based on the ITU-T Image No.1.
Individual Transmission Journal	A report that is printed by the transmitting unit stating information regarding the last document transaction.
Information code	A code that is internally generated by your Fax stating a specific operational error or machine failure.
Initial sending station	In a relay network, the station that is originating the document transmission.
Journal	A report that is printed by your unit listing the last 100* transmitting and receiving transactions. (* UF-550/560 : last 32 transmitting)
Keypad	A group of numeric keys located on your control panel.
LCD	Liquid Crystal Display. The display area of your machine.
LOGO	Your programmed company name or identification up to 25 alphanumeric characters.
Multiple Logo	The user can select one of 25 preset LOGOs before a transmission.
Manual reception	A mode that requires operator intervention to receive an incoming document.
Memory transmission	The documents are scanned into memory before actual connection to the phone line for transmission.
Modem	A device that converts signals from your fax machine into signals that can be transmitted over telephone lines.

Multi-station transmission	The ability to broadcast the same set of documents to a programmed number of locations.
Multi-file transmission	The ability to store many files into your machine's memory before actual telephone connection occurs.
Network address	An individual 4-digit addressing number assigned to a One-Touch/Abbreviated number that identifies a particular station in a relay network.
Network password	A 4-digit password assigned to a network address to prevent unauthorized stations from accessing a relay station.
Off-hook dialling	The direct dialling of a telephone number with the handset out of the cradle or "off the hook."
OMR-XMT	Is used to transmit to a system, such as Fax Server, that has OMR Sheet reading capability.
On-hook dialling	The direct dialling of a telephone number with the handset in the cradle or "on the hook."
One-Touch dialling	The ability to dial an entire telephone number by pressing one key.
Overlap Printing	Documents too long to be reduced are automatically printed on two pages with approximately 10 mm overlap.
Panasonic Super Smoothing	An electronic image enhancement (Panasonic Super Smoothing) that will create a particular pattern for the improvement of copy quality.
Polling	The ability to retrieve a document from another facsimile machine.
Polling password	A 4-digit programmed code that enables the security of a document being polled.
Power Failure Report	A report that contains information on the last transaction that took place during a power outage.
Power Saver Mode	To reduce the power consumption of the machine in standby, select the time period to turn OFF the high temperature fuser unit when the printer is idle.
Print Collation	The ability to stack received documents in the correct order.
Print reduction modes	The methods used to determine how an incoming document will be reduced to print onto the paper loaded in your machine.
Program keys	Keys that are defined for storing a sequence of stations to be dialed or polled.
PSTN	Public Switched Telephone Network. Network of interconnected switching equipment and transmission facilities.
Receiving password	A 4-digit password that is checked before a document is received.

Glossary

Relay station	A certain type of facsimile machine that can store and forward documents to an end receiving station and/or a relay station in another relay network. Your machine can not be used as a relay station.
Relay network	A group of facsimile machines that communicate via a relay station.
Relay Transmission	Sending a document to a relay station, which in turn, sends the document to the end receiving station.
Relay Transmission Report	A report that contains information regarding the last document transmission to a relay station.
Relay address	A 2-digit code that identifies your machine is programmed in a relay network.
RESOLUTION	Relates to the number of dots scanned or printed per certain square. The quality of the image increases as the number of dots per certain square increases.
Selective reception	A function that can be set so that your unit will receive from only those machines programmed into your dialer.
Station name	Alphanumeric ID which can be programmed for each One-Touch dialling and Abbreviated dialling number.
Stored documents	Documents that have been scanned and now are stored in your machine's memory.
Sub-address	ITU-T recommendation for further routing, forwarding or relaying of incoming faxes.
Sub-address Password	ITU-T recommendation for additional security that corresponds to the Sub-address.
Substitute memory reception	Your machine's ability to store an incoming document into its memory, when it runs out of recording paper or toner.
Transmission reservation	The ability to preset a telephone number so that you may reserve a transmission while your unit is performing another function.
Transmission password	A 4-digit password that is checked when a document is transmitted.
User parameter	Programmed parameters that provide information to other stations. Examples are logo, character ID, date and time.
Verification stamp	A user selectable transmission verification stamp can be placed on scanned documents that are successfully transmitted or stored in memory.
View Mode - File List	Allows you to view the brief contents of the memory files through the LCD display without having to print the Memory File List.
View Mode - Journal	Allows you to view the brief contents of the journal through the LCD display without having to print the journal.

INDEX

A	
ABBR. Number List	148
Abbreviated Dialling Numbers	29
ADF Capacity	165
Automatic Document Feeder	40
Automatic Reception	60
Automatic Reduction	61
C	
Character ID	27
Character Key	10
Communication Journal (COMM. JOURNAL)	43, 145
Confidential Code	117
Confidential Communication	117
Confidential Mailbox	117
Contrast	41
Copy	64
Cover Sheet	89
D	
Date and Time	25
Deferred Polling	66
Deferred Transmission	70
Department Code	98
Diagnostic Password	37
Dialling Method (Tone or Pulse)	23
Dimensions	167
Direct Transmission	51
Direct Transmission Reservation	58
Directory Search Dialling	54
Directory Sheet	33
Distinctive Ring Detection	88
Document Jam	159
Document Misfeeding	162
Document Size	165
Document Thickness	165
Document Tray	14
Dual Access	57
E	
Edit File Mode	76
F	
Fax Access Code	84
Fax Forward	93
Fax Parameter List	151
Fax Parameter Table	35
File List	76
File Transmission	94
Fixed Reduction	61
Flash	11
Function Key List	8
G	
Group Dialling	73
H	
Halftone	42
Header Format	35
Header Print	35
I	
ID Number	28
Image Memory Capacity	166
Incomplete File	36
IND. XMT JOURNAL	142
Information Codes	155
Initial Sending Station	128
J	
Journal	141
K	
Key/Buzzer Volume	35
L	
Loading Documents	39
LOGO	26
M	
Memory Card	169, 171
Memory Transmission	44
Monitor Volume	24
Multi-Station Transmission	50
Multiple LOGO	107
N	
Network Address	131
Network Password	131
O	
Off-Hook Dialling	55
OMR-XMT	91
On-Hook Dialling	56
One-Touch Dialling Numbers	29
One-Touch Keys	29
One-Touch List	148
Operating Environment	167
Overlap Printing	62
Own Network Address	131

Own Telephone Number	131
P	
Paper Specification	18
Password Reception	112
Password Transmission	112
Pause	11
Polling	67
Polling Password	67
Power Consumption	167
Power Failure Report	152
Pressure Adjusting Lever	162
Print Collation	63
Print Margin	166
Print Reduction	61
Print Reduction Ratio	61
Priority Transmission Reservation	58
Program Keys	70
Program List	150

R

Receive To Memory	86
Received Time Print	35
Receiving Password	114
Recording Paper Jam	158
Recording Paper Specification	168
Redial	59
Reduction Ratio	61

Relay Address	131
Relay Network	128
Relay Station	128
Relay Station Parameter	131
Relay XMT Report (COMM. JOURNAL)	136
Result Report	136
Retry Incomplete File	83
Ringer Volume	24

S

Scanner Resolution	165
Selective Reception	111
Sub-address Password	37
Sub-addressing	138
Substitute Memory Reception	63

T

Timer Controlled Communications	66
Toner Cartridge	17
Transmission Password	113
Transmission Reservation	57

U

User Parameters	25
-----------------------	----

V

Verification Stamp	42, 163
--------------------------	---------

W

Weight	167
--------------	-----

Facsimile Number Directory

Name

Number

Panafax®

Facsimile

UF-550

UF-560

UF-770

Matsushita Graphic Communication Systems, Inc.

CORPORATE OVERSEAS SALES AND

OPERATION MANAGEMENT DEPARTMENT

2-3-8 Shimomeguro, Meguro-ku, Tokyo, Japan 153

Printed in Japan
DZSD000539-3